

COLLECTION 2020 | 01

catalog



ABOUT TIGER HOTEL	4
COLLECTION INDEX	6
VINTAGE COLLECTION	10
MODULAR BUFFET SYSTEM	20
LED BUFFET AND TABLE ACCESSORIES	48
CARVING STATIONS & HEATING LAMPS	54
INDUCTION CHAFING DISHES	62
ROLL TOP CHAFING DISHES	88
CHAFING DISHES ACCESSORIES	104
URNS & DISPENSERS	118
BUFFET PRESENTATION	140
HOLLOWWARE	178
FLATWARE	196
TROLLEYS	210





Designing Tiger products is a global affair that starts with our Italian designers and finishes with Korean dedication to quality.

Tiger is a leading manufacturer of high quality buffet ware and multi-purpose trolleys headquartered in S. Korea with production sites both in Seoul Korea and Tianjin China.

With the new 20,000 sqm of factory and show room in Tianjin, Tiger can bring more innovative and value-added products to you. Our new 20,000 sqm factory will enable us to continue developing new innovations and value through quality.

Tiger believes that the products that we offer to the customers should be:

- technologically advanced,
- elegantly designed,
- competitively priced.

We use the highest quality materials in the market today. We meet or exce-

ed all European and American food safety standards. Tiger welcomes OEM/ODM as well.

The company motto is "no compromise in quality". Best hoteliers value our quality (complete reference list on www.tigerhotel.co.kr).

Tiger made history in the early 1980s when Mr. M. Y. Chang, Chairman of Tiger, founded Daijin Enterprise to manufacture service trolleys in a small workshop in South Korea. As a young man, he saw the growing opportunity in hospitality industry in Korea with Seoul Olympics games held in 1988. Daijin's modern service trolleys were quickly sought after restaurants and hotels.

Growing from this heritage, Tiger was founded in 1996 and began to export. The synergy of old world craftsmanship from its Mother Company and in-

novation made Tiger to become an industry leader in just a few short years. Tiger built a factory in Tianjin China in order to explore the growing Chinese market and to mass-produce products in 2001 and in 10 years it was expanded to 20,000 sqm of factory, warehouse, show room and office.

To ensure that quality is maintained, Mr. Chang-chairman, appointed his son to oversee the manufacturing. With the opening of a design centre in Italy in 2005, making Tiger products became a truly global affair. Italian designers work with Korean engineers and the projects are realized as products in the newest and modern Chinese production.

Tiger's vision for the future is to bring value through quality in a larger range of table top product to become a reliable partner for the best hotels worldwide.

about Tiger



European Office
YEGAM S.R.L.

Via Ratti 4/6
26015 Soresina (CR) Italia
Ph. +39 0374 948 000
Fax +39 0374 254 508
www.yegam.it

Factory & China Sales
MYUNGJIN TABLEWARE CO LTD.

06. Hongsheng Road
Jinnan Beizhakou Industrial Park
Tianjin China China
Ph. +86 22 8851 6661
Fax +86 22 8851 6663
www.tigerhotel.co.kr

Headquarter
TIGER COMPANY LTD.

15-1, Dogogan-gil, Chowol-eup, Gwangju-si,
Gyeonggi-do, KOREA, 464-861
Ph. +82 31 766 5888
Fax +82 31 766 0451
www.tigerhotel.co.kr

American Office
SMART BUFFETWARE LLC

26149 Capital Drive
Daphne, Alabama 36526-6195
Ph. +1 877 463 3388
Fax +1 877 473 9397
International +1 251 589 7834
www.smartbuffetware.com



worldwide distributors

BEST HOTELIERS VALUE OUR QUALITY.
COMPLETE REFERENCE LIST ON WWW.TIGERHOTEL.CO.KR



UNFORGETTABLE
BUFFET
EXPERIENCE.

Our best technology
and design will bring
your buffet scene to
the next level.



MODULAR BUFFET SYSTEMS

- 28 Domino combinations
- 34 Domino single unit
- 45 Domino croissant (bread) warmer
- 46 Domino magnetic induction platform



LED BUFFET AND TABLE ACCESSORIES

- 50 Led light products
- 52 Domino led light



CARVING STATIONS AND HEATING LAMPS

- 56 T-Collection
- 58 Domino buffet system collection
- 60 Domino Carving Stations and heating lamps



INDUCTION CHAFING DISHES

- 64 T-Collection
- 70 Smart W collection
- 78 Smart collection
- 80 Artisan-Casting chafer collection
- 86 Induction hob



ROLL TOP CHAFING DISHES

- 90 T-Collection
- 92 Ibis collection
- 94 Euri collection
- 96 Odin collection
- 98 Contemporary collection
- 99 Ouzi collection
- 100 Mini chafer collection
- 102 Electric heaters



CHAFING DISH ACCESSORIES

- 106 How to make soup urn
- 107 Chafing dish accessories
- 108 Stainless steel food pans
- 110 Porcelain food pans
- 112 Ceramic coated S.S. food pans
- 114 Serving spoons
- 116 Accessory compatibility chart



URNS & DISPENSERS

- 120 Smart W Soup Urn
- 121 Odin soup and coffee urns
- 122 Euri coffee urns
- 123 Ibis coffee urns
- 124 Dispenser set
- 126 T-Collection dispensers
- 132 Hi-line dispensers
- 133 Euri dispensers
- 134 Odin dispensers
- 138 Wood collection dispensers



BUFFET PRESENTATION

- 144 Stands and risers
- 154 Displays
- 156 Trays
- 158 Bowls
- 162 Stands
- 176 Presentation sets



HOLLOWWARE

- 182 Coffee & tea pots
- 183 Water pitchers
- 184 Double wall coffee pots & thermos
- 186 Wine coolers
- 192 Others



FLATWARE

- 198 Amalfi 7 mm
- 200 Bolsena 5.5 mm
- 202 Cortina 5 mm
- 204 Garda 3 mm
- 206 Iseo 5 mm
- 208 Maggiore 6 mm



TROLLEYS

- 212 Service trolleys
- 218 Room service trolleys & hot food warmers
- 222 Dish rack carts & stacking trolleys
- 224 Luggage carts, house keeping & canvas trolleys

The soul of stylish vintage combined with old-world charm.



There is something to be said about nostalgia when it comes to vintage trend. Aspiring the trend from another period can be a sort of escape or consolation from contemporary stresses for the people of twenty-first century.

That vintage style keeps 1920s fashions at its core because in many respects, 1920s American society represents the good old days of prosperity. It was a decade of indulgence, rapid economic growth.

The Artisan, premium aluminum casting chafer. The comfort of home served by professionals.





















Modular buffet system-Domino



Domino is a completely new concept in modular buffet system. All the Domino components can interlock or stand alone. Simply connect components to build your designed buffet. When tomorrow comes build it again or try something new. Domino is made from food grade 18/10 Stainless steel. Built and design to endure the abuse of a commercial operation. Domino heated components can use caned fuel or electric; domino's easy lock & unlock leg system makes it simple to change height; no tools or complicated instructions; simply insert and twist. The base modules consist of 3 sizes: 25 cm (9.75") square; 35 cm (13.75") square; 62x35 cm (24.25" x 13.75") rectangle. Each base unit is 9 cm (3.50") tall. The unit can simply share legs or the height can be increased by 9 cm (3.50") increments to create beautiful high and low horizon on the buffet scene. To add a leg/height just insert and twist. No tools required. You build it and they will come. **Let your imagination design your Buffet. The system is so simple, a child can do it. Simply put, Domino makes it fun again!**

PATENT KOREA: 20-0458123; 20-0481867; 30-0601673. PATENT CHINA: 2448616; 1959783.

ASSEMBLE YOUR DOMINO AND MAKE YOUR OWN.



1. All components interchangeable
2. Easy lock & unlock leg system
3. Stackable stand
4. Corner to corner linkable system
5. Easy building blocks for better buffet

THE BUILDING BLOCKS FOR A BETTER BUFFET IS BEYOND YOUR IMAGINATION!



Risers and displays
Juice/milk/cereal dispensers
Carving boards
Heating lamps
Dome covers
Soup and hot stations
Condiment stands
Sauce chafers
Chafing dishes
Chafing dishes
Magnetic induction platforms
Utensils

DOMINO IS THE BEST CHOICE!



THE SYSTEM GIVES YOU THE FLEXIBILITY TO COMPLETELY REDESIGN YOUR BUFFETS BASED ON YOUR MENU.

EVERY DAY DOMINO GIVES YOU A NEW CANVAS TO WORK WITH.



COOKING IS ART. DOMINO IS YOUR CANVAS.

DOMINO SQUARE MODULE 25 CM.



DOMINO SQUARE MODULE 35 CM.



DOMINO COMBINATION

These 7 demonstration of the Domino modular buffet is just one of thousands combinations that you can make.





Domino Bread & CO. - Bread station

Code: 19425-000
Items: 19411-090; 19413-090; S1-19402-260 (x2); 19402-180; 19413-BGT



Domino Sushi & Roll - Cold station

Code: 19431-000
Items: 19415-090 (x2); 11206-250; 11207-250 (x2); 19414-090 (x2); S1-19402-260



Domino Cereal Fantasia 1 - Cereal station

Code: 19427-000

Items: 19412-090 (x2); 19404-180



Domino Vita ACE 1 - Juice station

Code: 19429-000

Items: 19403-180 (x3); S1-19402-260



Domino Sweet Treat Station - Dessert station

Code: 19433-000

Items: 19405-090 (x4); 19405-PCB; 19406-090; 11206-250; 19414-090; S1-19402-260 (x3); 19405-WNT (x2); 19421; 18929



Domino hot station

Code: 19432-000

Item: 19407-180; 19406-090; 19405-180; 19405-IDT; 19406-IDT; 15800-CHO; 15801-CHO; 11762-230 (x2)





Domino Green Therapy - Salad Station

Code: 19426-000

Item: 19402-090 (x2); 19403-PCB (x2); 19405-180; 19405-PCB (x2); 19406-180; 11207-250 (x2); S1-19402-206 (set); 19409-180 (x2); 19423



DOMINO SINGLE UNIT



Domino sauce chafing dish

Material: Stainless steel 18-10; Porcelain; Corian

Code: 19401-180

Size: L250 x W250 x H312 mm

Weight: 5.56 kg

Capacity: 0.8 Ltr



Domino juice dispenser - single (3.5 Ltr)

Material: Stainless steel 18-10; Polycarbonate cylinder; Acacia wood

Code: 19403-180

Size: L250 x W330 x H434 mm

Weight: 6.68 kg

Capacity: 3.5 Ltr



Domino milk dispenser (5 Ltr)

Material: Stainless steel 18-10; Acacia wood

Code: 19404-180

Size: L250 x W324 x H458 mm

Weight: 7.06 kg

Capacity: 5.0 Ltr



Domino coffee urn (3.8 Ltr)

Material: Stainless steel 18-10

Code: 19435-180

Size: L255 x W322 x H423 mm

Weight: 4.31 kg

Capacity: 3.8 Ltr



Domino cereal dispenser - single (3.7 Ltr, 9 cm)

Material: Stainless steel 18-10; Polycarbonate cylinder

Code: 19412-090

Size: L250 x W264 x H621 mm

Weight: 5.06 kg

Capacity: 3.7 Ltr



Domino cereal dispenser - single (3.7 Ltr, 18 cm)

Material: Stainless steel 18-10; Polycarbonate cylinder; Acacia wood

Code: 19412-180

Size: L250 x W264 x H713 mm

Weight: 7.32 kg

Capacity: 3.7 Ltr



Domino dish stand (25x9 cm)

Material: Stainless steel 18-10

Code: 19402-090

Size: L250 x W250 x H103 mm

Weight: 1.84 kg

Compatible with: Chafing dishes accessories



Domino dish stand bronze vintage (25x9 cm)

Material: Bronze PVD coated Stainless steel; Stainless steel 18-10

Code: 19402-090-BRZ

Size: L250 x W250 x H103 mm

Weight: 1.84 kg

Compatible with: Chafing dishes accessories



Domino dish stand (25x18 cm)

Material: Stainless steel 18-10; Acacia wood

Code: 19402-180

Size: L250 x W250 x H196 mm















Weight: 4.10 kg

Compatible with: Chafing dishes accessories



NEW



<p>Domino porcelain bowl (25 cm) Material: Porcelain Code: 19403-PCB Package: 3 ea Size: L235 × W125 × H100 mm Weight: 1.24 kg Capacity: 1.1 Ltr</p> 	<p>Domino soup station stand Material: Stainless steel 18-10; Corian Code: 19407-180 Size: L350 × W350 × H323 mm Weight: 8.74 kg Capacity: 4.2 Ltr</p>  <p> WARM</p>	<p>Domino hot station stand Material: Stainless steel 18-10; Corian Code: 19408-180 Size: L350 × W350 × H196 mm Weight: 8.34 kg Capacity: 4.5 Ltr</p>  <p> WARM</p>
<p>Domino dish stand (35×9 cm) Material: Stainless steel 18-10 Code: 19405-090 Size: L350 × W350 × H103 mm Weight: 2.08 kg Compatible with: Chafing dishes accessories</p>  <p> STACKABLE</p>	<p>Domino dish stand bronze vintage (35×9 cm) Material: Bronze PVD coated Stainless steel; Stainless steel 18-10 Code: 19405-090-BRZ Size: L350 × W350 × H103 mm Weight: 2.08 kg Compatible with: Chafing dishes accessories</p>  <p> STACKABLE</p> <p> VINTAGE DESIGN PREMIUM QUALITY</p>	<p>Domino dish stand (35×18 cm) Material: Stainless steel 18-10; Acacia wood Code: 19405-180 Size: L350 × W350 × H196 mm Weight: 5 kg Compatible with: Chafing dishes accessories</p>  <p> STACKABLE</p>
<p>Domino porcelain bowl (35 cm) Material: Porcelain Code: 19405-PCB Package: 3 ea Size: L340 × W340 × H110 mm Weight: 2.50 kg Capacity: 3 Ltr</p> 	<p>Domino wooden tray Material: Acacia wood Code: 19405-WNT Size: D332 × H25 mm Weight: 0.8 kg</p> 	<p>Domino marble tray Material: Corian Code: 19405-MBT Size: D330 × H22 mm Weight: 1.82 kg</p> 

NEW



Domino complete bread cutting board

Material: Stainless steel 18-10; Acacia wood

Code: 19411-090

Size: L615 x W350 x H116 mm

Weight: 5.86 kg



STACKABLE



Domino complete bread basket

Material: Stainless steel 18-10; Polycarbonate dome cover; PE

Code: 19413-090

Size: L615 x W355 x H297 mm

Weight: 6.46 kg



Domino bread basket

Material: PE

Code: 19413-BAS

Size: L490 x W305 x H100 mm

Weight: 0.78 kg





Domino cold display with dome cover
 Material: Stainless steel 18-10; Polycarbonate dome cover
Code: 19414-090
 Size: L615 x W355 x H297 mm
 Weight: 9.82 kg
 Compatible with: PC Dome Cover 19927



Domino cold display without dome cover
 Material: Stainless steel 18-10
Code: 19415-090
 Size: L615 x W350 x H103 mm
 Weight: 7.88 kg



Domino Dome Cover
 Material: Polycarbonate dome cover
Code: 19927-BOM
 Size: L575 x W355 x H216 mm
 Weight: 1.94 kg





Domimo oblong dish stand (9 cm)

Material: Stainless steel 18-10

Code: 19406-090

Size: L615 x W350 x H101 mm

Weight: 2.76 kg

Compatible with: Chafing dishes accessories



STACKABLE



Domimo oblong dish stand bronze vintage (9 cm)

Material: Bronze PVD coated Stainless steel; Stainless steel 18-10

Code: 19406-090-BRZ

Size: L615 x W350 x H101 mm

Weight: 2.76 kg

Compatible with: Chafing dishes accessories



STACKABLE



NEW

Domimo oblong dish stand (18 cm)

Material: Stainless steel 18-10; Acacia wood

Code: 19406-180

Size: L615 x W350 x H196 mm

Weight: 6.76 kg

Compatible with: Chafing dishes accessories



STACKABLE





Domino oblong wooden tray

Material: Acacia wood

Code: 19406-WNT

Size: L527 × W321 × H28 mm

Weight: 1.68 kg



Domino bread cutting board

Material: Acacia wood

Code: 19411-BCB

Size: L526 × W325 × H28 mm

Weight: 1.10 kg



Domino oblong marble tray

Material: Corian

Code: 19406-MBT

Size: L525 × W325 × H22 mm

Weight: 3.64 kg





Domino buffet display 1 tier

Material: Stainless steel 18-10; PMMA (Acrylic)

Code: 19437-090 (black), 19436-090 (white)

Size: L615 × W250 × H103.5 mm

Weight: 2.5 kg



STACKABLE



Domino buffet display 2 tiers

Material: Stainless steel 18-10; PMMA (Acrylic)

Code: 19437-180 (black), 19436-180 (white)

Size: L615 × W427 × H196 mm

Weight: 5.2 kg



STACKABLE



Domino buffet display 3 tiers

Material: Stainless steel 18-10; PMMA (Acrylic)

Code: 19437-270 (black), 19436-270 (white)









Size: L615 × W604 × H288.5 mm

Weight: 8.3 kg



STACKABLE



<p>Domino extensible legs Material: Stainless steel 18-10; ABS</p> <p>Code: S1-19402-260 Package: 4 pcs/set Size: D28 × H105 mm Weight: 0.16 kg (1 ea)</p> 	<p>Domino square wooden base Material: Acacia wood</p> <p>Code: K1-19402-270 Size: L250 × W250 × H15 mm Weight: 0.86 kg</p> <p>Code: K1-19405-270 Size: L350 × W350 × H15 mm Weight: 1.54 kg</p> <p>Code: K1-19406-270 (oblong) Size: L615 × W350 × H15 mm Weight: 1.9 kg</p> 	<p>Domino condiment pole Material: Stainless steel 18-10; Porcelain</p> <p>Code: 19410-180 Package: 2 bowls and pole Size: L290 × W252 × H80 mm Weight: 2.22 kg</p> 
<p>Domino condiment pole Material: Stainless steel 18-10; Porcelain; Silicone</p> <p>Code: 19410-090 Package: 1 bowls and pole Size: L140 × W234 × H229 Weight: 1.15 kg</p> 	<p>Domino condiment porcelain Material: Porcelain</p> <p>Code: 11220-000 Package: 2 pcs/set Size: L177 × W118 × H48 mm Weight: 0.28 kg (1 ea) Capacity: 0.35 Ltr (1 ea)</p> 	<p>Domino serving utensil pole Material: Stainless steel 18-10; Porcelain</p> <p>Code: 19409-180 Package: 1 spoons, 1 fork and pole Size: L174 × W149 × H370 mm Weight: 1.62 kg Capacity: 0.35 Ltr (1 ea)</p> 
<p>Domino porcelain holder Material: Porcelain</p> <p>Code: 11223-000 Package: 2 pcs/set Size: D78 × H120 mm Weight: 0.44 kg (1 ea) Capacity: 0.35 Ltr (1 ea)</p> 	<p>Domino serving cutlery Material: Stainless steel 18-10</p> <p>Code: 11514-000 (fork) Package: 6 ea/set Size: L36 × W22 × H277 mm Weight: 0.20 kg (1 ea)</p> <p>Code: 11515-000 (spoon) Package: 6 ea/set Size: L55 × W26 × H280 mm Weight: 0.20 kg (1 ea)</p> 	

NEW



Domino utility stand

Material: Stainless steel 18-10; Porcelain; PMMA (Acrylic)

Code: 19423-000

Size: L337 x W270 x H487 mm

Weight: 3.71 kg



Platform not included

Domino fruit bowl (9 Ltr)

Material: Stainless steel 18-10; Acacia wood

Code: 19421-000

Size: L331 x W349 x H509 mm

Weight: 2.28 kg

Capacity: 9 Ltr



Domino napkin holder

Material: Stainless steel 18-10; Acacia wood

Code: 19422-000

Size: D206 x H176 mm

Weight: 0.9 kg



DOMINO CROISSANT (BREAD) WARMER



Domino croissant warmer

Material: Stainless steel 18-10; PE basket; Ceramic coated aluminium sheathed plate; PPS

Code: 19438-230

Heating plate: 230 V, 490 W

Size: L615 × W361 × H287 mm

Weight: 11 kg

Relate accessories: 11206-250, 11207-250



Croissant warmer can be also used as regular warmer for dry food.

DOMINO MAGNETIC INDUCTION PLATFORM

We proudly present the most Green and eco-friendly induction-heated banqueting equipment in the world. Not only does switching to induction enable you to help conserve materials, keep used fuel cans out of landfills, and eliminate greenhouse gas emissions, but switching to our particular product also allows you to warm food using 69% less electricity while impressing your guests with your conservation efforts.



Domino magnetic induction platform (square)

The 4 magnetics ensure the tight hold of the chafer onto the platform.

Material: Acacia wood; Magnet

Code: 19405-IDT

Size: L350 × W350 × H40.6 mm

Weight: 0.95 kg



Domino magnetic induction platform (oblong)

The 4 magnetics ensure the tight hold of the chafer onto the platform.

Material: Acacia wood; Magnet

Code: 19406-IDT

Size: L618 × W353 × H40.6 mm

Weight: 1.73 kg





Induction warmer (mini round, 300W)

Material: Stainless steel 18-10

Code: 11764-230

Size: D180 × H81.5 mm

Weight: 1.55 kg



Hold temperature of any Tiger induction chafer with only 300W max absorption. It can stay in operation without control panel up to 4 hours.

NEW

INDUCTION WARMER 11764-230

Product features:

- Safety Start Up
- Small Object Detection
- Empty Pot Detection
- Overheat Protection

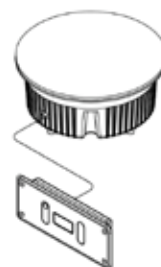

Specification:

Model	11764-230
Voltage	220-230V
Frequency	50/60Hz
Dimension	Dia. 180 × H81.5
Power Consumption	300W
Weight	1400g



*Massaman
curry*

LED buffet & table accessories









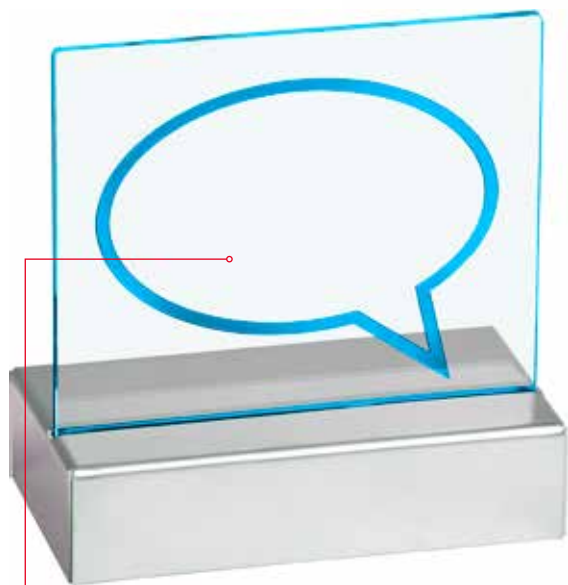

LED LIGHT PRODUCTS



Write with white neon marker and choose the color you like!



Lasting 30 hours for one-time charge!

<p>LED light menu stand Material: Stainless steel 18-10; Silicone; ABS; PMMA(Acrylic); PCB; Power supply; USB cable Code: 19943-230 Size: L133 × W70 × H134.7 mm Weight: 0.35 kg</p>   <p style="text-align: right;">NEW</p>	<p>LED table No. stand style1 Material: Stainless steel 18-10; Silicone; ABS; PMMA(Acrylic); PCB; Power supply; USB cable Code: 19945-230-001 Size: L133 × W70 × H344.7 mm Weight: 0.45 kg</p>   <p style="text-align: right;">NEW</p>	<p>LED table No. stand style 2 Material: Stainless steel 18-10; Silicone; ABS; PMMA(Acrylic); PCB; Power supply; USB cable Code: 19945-230-002 Size: L133 × W70 × H344.7 mm Weight: 0.40 kg</p>   <p style="text-align: right;">NEW</p>
<p>White Neon maker pan Code: 19011-100</p>  <p style="text-align: right;">NEW</p>	<p>Mobile sneeze guard with LED writable Material: Stainless steel 18-10; PMMA (Acrylic); Silicone; ABS; PCB; Power supply; USB cable Code: 19012-230; 19012-110 Size: L754.4 × W342 × H556 mm Max: 556 mm; Min: 416 mm Weight: 4.10 kg</p>  <p style="text-align: center;">Height adjustable</p> <p style="text-align: right;">NEW</p>	<p>Mobile sneeze guard writable Material: Stainless steel 18-10; PMMA (Acrylic); Silicone Code: 19011-000 Size: L754.4 × W342 × H556 mm Max: 556 mm; Min: 416 mm Weight: 3.80 kg</p>  <p style="text-align: center;">Height adjustable</p> <p style="text-align: right;">NEW</p>

DOMINO LED LIGHT



MULTICOLOR
LIGHT

We engrave your own logo or brand





Domino rechargeable type LED light

Material: Silicone; ABS; PCB; Power supply; USB cable

Code: 19439-000

Size: L128 × W43 × H30 mm

Weight: 0.12 kg



Domino Acrylic Skirt With LED light set (90 mm), 230V

Material: PMMA (Acrylic); Silicone; ABS; Power supply; USB cable

Code: 19439-090

Size: L311 × W43 × H65 mm

Weight: 0.19 kg



Domino Acrylic Skirt With LED light set (180 mm), 230V

Material: PMMA (Acrylic); Silicone; ABS; Power supply; USB cable

Code: 19439-180

Size: L311 × W43 × H155 mm

Weight: 0.32 kg





Carving stations & heating lamps



T-COLLECTION CARVING STATIONS AND HEATING LAMPS





T-Collection heating lamp stand gooseneck bronze vintage

Material: Bronze PVD coated Stainless steel; Stainless steel 18-10; Solid die casting; Powder coated steel (black)

Code: 19448-230-BRZ; 19448-110-BRZ

Rating: 110V, 250W / 230V, 375W (max)

Size: L363.7 x W210 x H761 mm

Weight: 6.60 kg



NEW

T-Collection heating lamp stand gooseneck 2-light bronze vintage

Material: Bronze PVD coated Stainless steel; Stainless steel 18-10; Solid die casting; Powder coated steel (black)

Code: 19449-230-BRZ; 19449-110-BRZ

Rating: 110V, 250W / 230V, 375W (max)

Size: L304.4 x W474.8 x H761 mm

Weight: 7.45 kg



NEW



Different cables are available on request

**T-Collection heating lamp stand gooseneck
110V & 230V**

Material: Stainless steel 18-10; Solid die casting; Powder coated steel (black); Powder coated steel

Code: 19446-230 & 19446-110
Rating: 110V, 250W / 230V, 375W (max)
Size: L404 × W196 × H761 mm
Weight: 5.71 kg



**T-Collection heating lamp stand gooseneck
2-light 110V & 230V**

Material: Stainless steel 18-10; Solid die casting; Powder coated steel (black); Powder coated stainless steel

Code: 19447-230 & 19447-110
Rating: 110V, 250W / 230V, 375W (max)
Size: L344 × W474.8 × H761 mm
Weight: 6.92 kg



**T-Collection rect. carving station base with
carving board**

Material: Stainless steel 18-10; Powder coated steel (black); Phenolic sheet (black) board

Code: 11763-000
Size: L768 × W592 × H125.5 mm
Weight: 13.8kg



T-Collection rect. fiber resin carving board

SGS approved No. TSNHG1500055102 A01
Material: Phenolic sheet (black)

Code: 11763-CVB-BLK
Size: L650 × W530 × H12 mm
Weight: 2.80kg



**Domino round carving station base with carving
board**

Material: Stainless steel 18-10; Phenolic sheet (black) board

Code: 11760-BSE
Size: L618 × W588 × H59.5 mm
Weight: 6.88kg



Fiber resin carving board (1 ea)

SGS approved No. TSNHG1500055102 A01
Material: Phenolic sheet

Code: 11760-CVB
Size: D495 × H12 mm
Weight: 3 kg



Domino heating lamp for 11760

Material: Stainless steel 18-10; Solid die casting; Aluminium; ABS (chrome plated)

Code: 19416-CS1
Rating: 110V, 250W / 230V, 375W (max)
Size: L176 × W350 × H626 mm
Weight: 1.8 kg
Compatible with: 11760-230



Domino round stackable carving station

Material: Stainless steel 18-10; Solid die casting; Phenol sheet

Code: 11760-230
Rating: 110V, 250W / 230V, 375W (max)
Size: L648 × W588 × H647 mm
Weight: 8.24 kg
Compatible with: 19416-CS1





FEATURE

- 1. No tools needed to remove heat lamp
- 2. All that touches food is dish washer safe
- 3. Liquid control in sub reservoir
- 4. Stackable for storage



BULB NOT INCLUDED IN THE HEATING LAMP

DOMINO CARVING STATIONS AND HEATING LAMPS



Heating lamp free stand (single lamp)

Material: Stainless steel 18-10; Solid die casting; Aluminium; ABS (chrome plated)

Code: 19417-110; 19417-230
Rating: 110V / 250W, 230V / 375W (max)
Size: L204 × W375 × H725 mm
Weight: 6.50 kg



Heating lamp free stand (single lamp)

Material: Stainless steel 18-10; Solid die casting; Aluminium; ABS (chrome plated)

Code: 19417-230-RGD (rose gold)
Rating: 110V / 250W, 230V / 375W (max)
Size: L204 × W375 × H725 mm
Weight: 6.50 kg



Heating lamp free stand (single lamp)

Material: Stainless steel 18-10; Solid die casting; Aluminium; ABS (chrome plated)

Code: 19417-230-BLK (black)
Rating: 110V / 250W, 230V / 375W (max)
Size: L204 × W375 × H725 mm
Weight: 6.50 kg



Domino heating lamp for clamp (single lamp)

Material: Stainless steel 18-10; Solid die casting; Aluminium; ABS (chrome plated)

Code: 19416-110; 19416-230
Rating: 110V, 250W / 230V, 375W (max)
Size: L176 × W350 × H657 mm
Weight: 2.34 kg





Induction chafing dishes



The induction chafing dishes from Tiger not only look great, but also are unique in design and effective in cost. This unit can be flush mounted utilizing induction heat, or our electric heater, or canned fuel. The clad bottom distributes heat evenly minimizing hot spots that cause food to stick and burn. The self-closing lid has adjustable patented hinges that will prevent food from getting cold. In addition, the lid can be removed with one hand for easy cleaning. The lid also has air vents that reduce condensation build up that could drip on the food. This condensation is captured by the water recycling system allowing less refilling of the water pan, decreasing labor costs. The handle keeps cool preventing burns. The entire chafer is repairable, making this a quality investment that will last for years to come.

THANKS TO ITS HIGH DENSITY MAGNETIC BOTTOM TIGER CHAFERS ARE THE MOST ENERGY EFFICIENT CHAFERS IN THE MARKET! SAVE ON THE ENERGY COST, CHOOSE TIGER!

T-COLLECTION



FEATURE

1. Three interchangeable color bands
2. The revolutionary infinite stop motion hinge
3. Water recycling system with easy no mess clean-up
4. Stackable stands for convenient storage
5. Counter handle for easy, safe transport





Easy detachment of the cover for Cleaning.



Counter handle for easy transportation.



Level adjustable foot.



Stackable stand with magnetic burner holder.



Water recycling system.

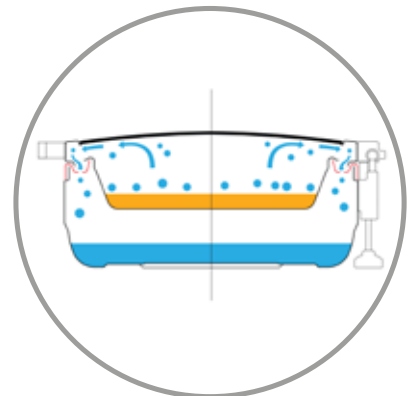



Compatible with stacking trolley Code: 91101.



Set includes chafer base, top, food pan & removable adaptor for easy water removal.



Infinite stop motion hinge™. Longer endurance with a quick easy adjustment.



T-Collection induction chafing dish (square)

Material: Stainless steel 18-10; Tempered glass; Solid die casting

Code: 15800-CHO

Size: L395 x W429.5 x H176.5 mm

Weight: 7.75 kg

Capacity: 5.5 Ltr



T-Collection induction chafing dish (square)

Material: Stainless steel 18-10; Tempered glass; Rose gold PVD coated stainless steel

Code: 15800-CHO-RGD (rose gold)

Size: L395 x W429.5 x H176.5 mm

Weight: 7.75 kg

Capacity: 5.5 Ltr



T-Collection induction chafing dish (square)

Material: Stainless steel 18-10; Tempered glass; Black PVD coated stainless steel

Code: 15800-CHO-BLK (black)

Size: L395 x W429.5 x H176.5 mm

Weight: 7.75 kg

Capacity: 5.5 Ltr



T-Collection induction chafing dish (round)

Material: Stainless steel 18-10; Tempered glass; Solid die casting

Code: 15801-CHO

Size: D420 x W484.5 x H155.5 mm

Weight: 7.6 kg

Capacity: 6 Ltr



T-Collection induction chafing dish (round)

Material: Stainless steel 18-10; Tempered glass; Rose gold PVD coated stainless steel

Code: 15801-CHO-RGD (rose gold)

Size: D420 x W484.5 x H155.5 mm

Weight: 7.6 kg

Capacity: 6 Ltr



T-Collection induction chafing dish (round)

Material: Stainless steel 18-10; Tempered glass; Black PVD coated stainless steel

Code: 15801-CHO-BLK (black)

Size: D420 x W484.5 x H155.5 mm

Weight: 7.6 kg

Capacity: 6 Ltr



T-Collection stackable stand (square)

Material: Stainless steel 18-10; PE; Powder coated steel;

Magnetic burner holder included

Can be used with induction warmer 11762-230 and magnetic induction lid 11123-000.

Code: 11281-000

Size: L465 x W372 x H251 mm

Weight: 3.92 kg



T-Collection stackable stand (round)

Material: Stainless steel 18-10; PE; Powder coated steel;

Magnetic burner holder included

Can be used with induction warmer 11762-230 and magnetic induction lid 11123-000.

Code: 11282-000

Size: D500 x W456 x H244 mm

Weight: 3.8 kg



Induction warmer

Code: 11764-230 (mini round, 300W)

Magnetic fixing ring for 11762

Code: 11123-000



See induction hob pages for specification



T-Collection rose gold band (square)

Material: Stainless steel 18-10; Rose gold PVD coated stainless steel; Silicone

Code: S1-15800-100-RGD

Size: L393 x W370 x H26 mm
Weight: 0.65 kg



T-Collection black band (square)

Material: Stainless steel 18-10; Black PVD coated stainless steel; Silicone

Code: S1-15800-100-BLK

Size: L393 x W370 x H26 mm
Weight: 0.65 kg



T-Collection rose gold band (round)

Material: Stainless steel 18-10; Rose gold PVD coated stainless steel; Silicone

Code: S1-15801-100-RGD

Size: D420 x H21 mm
Weight: 0.5 kg



T-Collection black band (round)

Material: Stainless steel 18-10; Black PVD coated stainless steel; Silicone

Code: S1-15801-100-BLK

Size: D420 x H21 mm
Weight: 0.5 kg



SMART W COLLECTION

While inheriting the legacy of Smart chafer, Smart W has been upgraded and enhanced with 100,000 times of opening and closing guarantee on the hinge mechanism and fun, futuristic modern design. PVD treatment available in rose gold or black.



Special finishing available on request for all Smart W.



Smart W oblong chafing dish with glass lid

Material: Stainless steel 18-10; Tempered glass

Code: 15706-135

Size: L581 x W435 x H210 mm

Weight: 9.3 kg

Capacity: 8 Ltr (11101-070 food pan)
12 Ltr (11101-100 food pan)

Compatible with: 10 cm high pans



Smart W oblong chafing dish with S.S. lid

Material: Stainless steel 18-10

Code: 15707-135

Size: L581 x W435 x H213 mm

Weight: 8.9 kg

Capacity: 8 Ltr (11101-070 food pan)
12 Ltr (11101-100 food pan)

Compatible with: 10 cm high pans



Smart W oblong stand

Material: Stainless steel 18-10; Solid die casting legs; Silicone

Code: 11266-000

Size: L565 x W440 x H140 mm

Weight: 4.56 kg

Compatible with: 15706; 15707



Smart W square chafing dish with glass lid

Material: Stainless steel 18-10; Tempered glass

Code: 15700-CHOB

Size: L410 x W440 x H180 mm

Weight: 6.8 kg

Capacity: 5.5 Ltr



Smart W square chafing dish with S.S. lid

Material: Stainless steel 18-10

Code: 15703-CHOB

Size: L410 x W440 x H178 mm

Weight: 6.5 kg

Capacity: 5.5 Ltr



Smart W square chafing dish with S.S. lid bronze vintage

Material: Stainless steel 18-10; Bronze PVD coated Stainless steel; Solid die casting

Code: 15703-CHOB-BRZ

Size: L410 x W440 x H178 mm

Weight: 6.5 kg

Capacity: 5.5 Ltr



NEW

Smart W square stand

Material: Stainless steel 18-10; Solid die casting legs; Silicone

Code: 11265-000

Size: L405 x W455 x H140 mm

Weight: 3.7 kg

Compatible with: 15700; 15703



Smart W round chafing dish with glass lid

Material: Stainless steel 18-10; Tempered glass

Code: 15701-CHOB

Size: L440 x W490 x H195 mm

Weight: 6.8 kg

Capacity: 6 Ltr

Code: 15702-CHOB

Size: L380 x W435 x H180 mm

Weight: 5.5 kg

Capacity: 4.5 Ltr



Smart W round chafing dish with S.S. lid

Material: Stainless steel 18-10

Code: 15704-CHOB

Size: L440 x W490 x H215 mm

Weight: 6.4 kg

Capacity: 6 Ltr

Code: 15705-CHOB

Size: L380 x W435 x H175 mm

Weight: 5.3 kg

Capacity: 4.5 Ltr





Level adjustable foot.

Smart W round chafing dish with S.S. lid bronze vintage

Material: Stainless steel 18-10; Bronze PVD coated
Stainless steel; Solid die casting

Code: 15704 - CHOB - BRZ
Size: L440 × W490 × H215 mm
Weight: 6.4 kg
Capacity: 6 Ltr



NEW

Smart W round stand

Material: Stainless steel 18-10; Solid die casting legs;
Silicone

Code: 11264-000
Size: L300 × W420 × H140 mm
Weight: 3.5 kg
Compatible with: 15702; 15705; Soup Urn 16800







If storage space is a problem for you, the Smart W stackable stand is a smart choice.
STACKABLE UP TO 5.



Smart W stackable chafer stand (square)

Magnetic burner holder included.
Can be used with induction warmer 11762-230 and magnetic induction lid 11123-000.
Material: Stainless steel 18-10; Magnet; PE

Code: 11275-000
Size: L472 × W382.5 × H257 mm
Weight: 4.7 kg

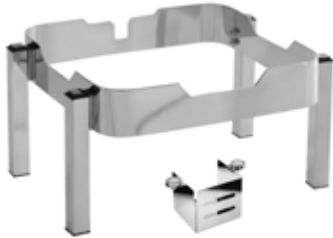

Smart W stackable chafer stand (oblong)

Magnetic burner holder included.
Can be used with induction warmer 11762-230 and magnetic induction lid 11123-000.
Material: Stainless steel 18-10; Magnet; PE

Code: 11274-000
Size: L648 × W381 × H268 mm
Weight: 5.6 kg

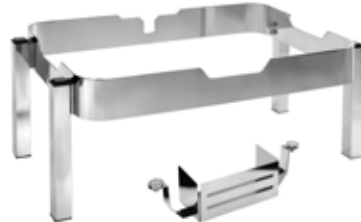

Smart W stackable chafer stand (round)

Magnetic burner holder included.
Can be used with induction warmer 11762-230 and magnetic induction lid 11123-000.
Material: Stainless steel 18-10; Magnet; PE

Code: 11276-000
Size: L514 × W514 × H247 mm
Weight: 4.5 kg
Compatible with: 15701; 15704

Code: 11277-000
Size: L456 × W456 × H247 mm
Weight: 4.3 kg
Compatible with: 15702; 15705



Smart W soup urn with glass lid (10 Ltr)

Material: Stainless steel 18-10; Tempered glass

Code: 16800-000
Size: L474 × W434 × H303 mm
Capacity: 10 Ltr
Weight: 7 kg
Compatible with: Smart W round stand 11264; Soup bucket K1-16800-230



Smart W spoon holder

Material: Stainless steel 18-10; Porcelain spoon not included

Code: 11272-000
Size: L150 × W131 × H87 mm
Weight: 0.22 kg



Smart W porcelain spoon holder

Material: Porcelain

Code: 11273-000
Size: L235 × W105 × H48 mm
Weight: 0.28 kg



SMART COLLECTION



Smart square chafing dish with stainless steel lid

Material: Stainless steel 18-10; Solid die casting handle
Back supporter and spoon holder hook not included.

Code: 15600-CHO; 15600-000 (drop-in)

Size: L453 x W407 x H200 mm

Weight: 6.8 kg; 6.6 kg (drop-in)

Capacity: 5.5 Ltr



Smart square chafing dish with glass lid

Material: Stainless steel 18-10; Solid die casting handle;
Tempered glass

Back supporter and spoon holder hook not included.

Code: 15601-CHO; 15601-000 (drop-in)

Size: L453 x W407 x H195 mm

Weight: 6.5 kg; 5.4 kg (drop-in)

Capacity: 5.5 Ltr



Smart round chafing dish with stainless steel lid

Material: Stainless steel 18-10; Solid die casting handle
Back supporter and spoon holder hook not included.

Code: 15300-CHO; 15300-000 (drop-in)

Size: L435 x W505 x H225 mm

Weight: 8.0 kg; 7.8 kg (drop-in)

Capacity: 6 Ltr



Smart round chafing dish with glass lid

Material: Stainless steel 18-10; Solid die casting handle;
Tempered glass
Back supporter and spoon holder hook not included.

Code: 15301-CHO; 15301-000 (drop-in)
Size: L435 × W505 × H202 mm
Weight: 8.4 kg; 8.2 kg (drop-in)
Capacity: 6 Ltr



Smart round chafing dish with stainless steel lid

Material: Stainless steel 18-10; Solid die casting handle
Back supporter and spoon holder hook not included.

Code: 15302-CHO; 15302-000 (drop-in)
Size: L378 × W442 × H193 mm
Weight: 5.5 kg; 5.3 kg (drop-in)
Capacity: 4.5 Ltr



Smart round chafing dish with glass lid

Material: Stainless steel 18-10; Solid die casting handle;
Tempered glass
Back supporter and spoon holder hook not included.

Code: 15303-CHO; 15303-000 (drop-in)
Size: L378 × W442 × H184 mm
Weight: 5.7 kg; 5.5 kg (drop-in)
Capacity: 4.5 Ltr



Smart round stand

Material: Stainless steel 18-10; Solid die casting handle;
Silicone

Code: 11259-000
Size: L410 × W295 × H150 mm
Weight: 3.38 kg
Compatible with: 15300; 15301

Code: 11260-000
Size: L375 × W265 × H150 mm
Weight: 3.28 kg
Compatible with: 15302; 15303



Smart square stand

Material: Stainless steel 18-10; Solid die casting handle;
Silicone

Code: 11261-000
Size: L415 × W353 × H150 mm
Weight: 3.48 kg
Compatible with: 15600; 15601



Smart serving spoon holder for smart round

Material: Stainless steel 18-10

Code: 11268-000
Size: L220 × W118 × H35 mm
Weight: 0.2 kg



Smart serving spoon holder for smart square

Material: Stainless steel 18-10

Code: 11269-000
Size: L240 × W110 × H35 mm
Weight: 0.22 kg





THE ARTISAN COLLECTION BY TIGER

The comfort of home served by professionals.



Square casting chafer with wood handle

Material: Al casting body; Tempered glass; Phenol; Stainless steel 18-10 Food pan; Silicone

Code: 15900-BL1

Size: L460 x W280 x H206 mm

Weight: 4.410 kg

Capacity: 4.5 Ltr

Code: 15900-BL2 (black handle)

Size: L460 x W280 x H206 mm

Weight: 4.410 kg

Capacity: 4.5 Ltr



NEW

Square casting chafer with black handle

Material: Al casting body; Tempered glass; Phenol; Stainless steel 18-10 Food pan; Silicone

Code: 15900-RED

Size: L460 x W280 x H206 mm

Weight: 4.410 kg

Capacity: 4.5 Ltr



NEW

Round casting chafer with wood handle

Material: Al casting body; Tempered glass; Phenol; Stainless steel 18-10 Food pan; Silicone

Code: 15901-BL1

Size: L449 x W330 x H209 mm

Weight: 4.330 kg

Capacity: 4.5 Ltr

Code: 15901-BL2 (black handle)

Size: L449 x W330 x H209 mm

Weight: 4.330 kg

Capacity: 4.5 Ltr



NEW



Round casting chafer with black handle
 Material: Al casting body; Tem-pered glass; Phenol;
 Stainless steel 18-10 Food pan; Silicone

Code: 15901-RED
 Size: L449 x W330 x H209 mm
 Weight: 4.330 kg
 Capacity: 4.5 Ltr



NEW

Inductive bottom







NOTICE FOR ARTISAN IN 2020

For Artisan 2020, S.S. food pan is included as standard set. Ceramic coated S.S. food pan and porcelain inserts are available as optional items.

Ceramic Food Pan: 11316-WHT (Round)
11318-WH2(Square)

Porcelain Insert: 11210-000 (Round)
11211-000 (square)

<p>Multi stand square black Material: Stainless steel 18-10; Powder coated steel (black); Silicone Compatible with mini induction and electric spring heater Code: 19600-000-BLK Size: L360 × W360 × H174 mm Weight: 3.95 kg</p>  <p>NEW</p>	<p>Multi stand square bronze vintage Material: Stainless steel 18-10; Powder coated steel (bronze); Silicone Compatible with mini induction and electric spring heater Code: 19600-000-BRZ Size: L360 × W360 × H174 mm Weight: 3.95 kg</p>  <p>NEW</p>	<p>Multi stand square black Material: Stainless steel 18-10; Powder coated steel (black) Compatible with electric spring heater, sterno and mini induction Code: 19600-STN-BLK Size: L360 × W360 × H174 mm Weight: 3.95 kg</p>  <p>NEW</p>
--	---	--



Ceramic coated stainless steel 18-10 food pan,
recommended wood or silicone spoon



Parked position



Home style design

Light aluminum casting body



INDUCTION HOB

When using any of Tigers induction chafers and combining them with Tigers Induction heaters you will accomplish many good things: going green, use less energy, run more chafers on a single power circuit, possibly eliminate the need to re-wire the building. Induction heaters require induction ready pans and chafers.



Anti skid silicone pad for induction.



Low consumption induction warmer!



Smart adaptor for built-in induction

Material: Stainless steel 18-10
Easy adaptor to transform to free standing induction hob.
Detachable back-supporter for Smart chafer.

Code: 11120-NEW
Size: L417 x W459 x H85 mm
Weight: 2.4 kg
Compatible with: 11758-230



Smart W oblong adaptor for built-in induction

Material: Stainless steel 18-10; Solid die casting
Easy adaptor to transform to free standing induction hob.
Detachable back-supporter for Smart chafer.

Code: 11120-OBL
Size: L458.5 x W576.5 x H84 mm
Weight: 3.4 kg
Compatible with: 11758-230



Smart induction hob with touch panel

Remote controller not included

Code: 11758-230
Rating: 230 V, 50/60 Hz, 1 KW (11758-230)
Size: L355 x W355 x H77 mm
Weight: 3.3 kg



Smart remote controller for induction 11758-230

Code: 11758-300
OPTIONAL



Remote controller for 11764-230

Code: 11764-300
OPTIONAL



Induction warmer (mini round, 300W)

Rating: 230V, 50/60Hz, 200~600W

Code: 11764-230
Size: D180 x H81.5 mm
Weight: 1.55 kg



Holds temperature at 300 Watts with Smart chafers.
Heat continuously for 4 hours non-stop
without connected control panel.

NEW

NEW

Magnetic fixing ring for 11762

Material: Stainless steel 18-10; Magnet

Code: 11123-000
Size: D268 x H19 mm
Weight: 1.6 kg



Anti skid silicone pad for induction

Material: Silicone

Code: 11759-000
Size: D263 x H2 mm
Weight: 0.1 kg





1. Removable lid opens at 90° and 180° degrees for serving versatility.



2. Dripless Waterpan.



3. Fully functional automatic slow-down system.



Roll top chafing dishes



Oblong Roll Top Chafing Dishes are made of solid 18-10 Stainless steel. The structure is sturdy due to 3 mm gauge frames. The lid opens to 90° and 180° for serving versatility and has an auto-braking system to prevent slamming. The lid will roll back to 90° and stop. To continue to 180° simply push the lid beyond the stop. This will help keep food warm more efficiently.

The water control system will decrease labor by recycling the condensation from the lid to the water pan. In addition, the lid can be removed for easy cleaning.

The handle keeps cool preventing burns.

The chafer is repairable, making this a quality investment that will last for years to come.

T-COLLECTION

Space is always an issue in busy outlets! We have a smart solution for that. Square stackable legged roll top chafing dishes are not only convenient but also appealing in modern contemporary banquets.

It guarantees stable stacking up to 5 units.

Recommended with: 91101 Ibis Stacking Trolley; 91101-PVC Ibis Stacking Trolley PVC Cover.



Round stackable roll top chafing dish (large)
Material: Stainless steel 18-10; PE

Code: 17910-000
Size: L518 x W514 x H470 mm
Weight: 8.4 kg
Capacity: 6 Ltr



Round stackable roll top chafing dish (medium)
Material: Stainless steel 18-10; PE

Code: 17920-000
Size: L440 x W442 x H391 mm
Weight: 7.73 kg
Capacity: 4.5 Ltr



Round stackable roll top chafing dish bronze vintage
Material: Stainless steel 18-10; PE; Bronze PVD coated Stainless steel

Code: 17910-000-BRZ
Size: L518 x W514 x H470 mm
Weight: 8.4 kg
Capacity: 6 Ltr



NEW

Oblong stackable roll top chafing dish
Material: Stainless steel 18-10; PE

Code: 17900-000
Size: L692 x W483 x H453 mm
Weight: 13.43 kg
Capacity: 8 Ltr



Oblong stackable roll top chafing dish bronze vintage
Material: Stainless steel 18-10; PE; Bronze PVD coated Stainless steel

Code: 17900-000-BRZ
Size: L692 x W483 x H453 mm
Weight: 13.43 kg
Capacity: 8 Ltr



NEW

IBIS COLLECTION

If storage space is a problem for you, the Ibis Chafing Dish is a smart choice. The Ibis chafing dishes are stackable, so they require a fraction of the normal storage space when not in use. Thanks to its unique design, the Ibis Chafing Dish is cost effective. Ibis chafing dishes are stackable up to 5.



Ibis oblong roll top chafing dish

Material: Stainless steel 18-10; Solid die casting handle

Code: 17510-000

Size: L667 × W485 × H452 mm

Weight: 14 kg

Capacity: 8 Ltr



Ibis round roll top chafing dish

Material: Stainless steel 18-10; Solid die casting handle

Code: 17610-000 Large

Size: L515 × W518 × H470 mm

Weight: 11 kg

Capacity: 6 Ltr

Code: 17710-000 Medium

Size: L441 × W442 × H395 mm

Weight: 8 kg

Capacity: 4.5 Ltr



Ibis stacking trolley

Material: Powder coated steel pipe; Rubber carpet

Code: 91101-000

Size: L980 × W695 × H1546 mm

Weight: 30 kg



Ibis stacking trolley pvc cover

Material: PVC

Code: 91101-PVC

Size: L980 × W710 × H1400 mm (folded: H100 mm)



EURI COLLECTION



Euri oblong chafing dish with brass legs

Material: Stainless steel 18-10; Solid die casting handle and legs

Code: 1271D-B00

Size: L667 × W488 × H452 mm

Weight: 18.5 kg

Capacity: 8 Ltr



Euri round chafing dish with brass legs

Material: Stainless steel 18-10; Solid die casting handle and legs

Code: 1281D-B00

Size: L515 × W497 × H468 mm

Weight: 14.5 kg

Capacity: 6 Ltr



Euri round chafing dish with brass legs

Material: Stainless steel 18-10; Solid die casting handle and legs

Code: 1282D-B00

Size: L435 × W425 × H410 mm

Weight: 11.20 kg

Capacity: 4.5 Ltr



Euri oblong chafing dish with chrome legs

Material: Stainless steel 18-10; Solid die casting handle and legs

Code: 1271D-CHO

Size: L667 × W488 × H452 mm

Weight: 18.5 kg

Capacity: 8 Ltr



Euri round chafing dish with chrome legs

Material: Stainless steel 18-10; Solid die casting handle and legs

Code: 1281D-CHO

Size: L515 × W497 × H468 mm

Weight: 14.5 kg

Capacity: 6 Ltr



Euri round chafing dish with chrome legs

Material: Stainless steel 18-10; Solid die casting handle and legs

Code: 1282D-CHO

Size: L435 × W425 × H410 mm

Weight: 11.20 kg

Capacity: 4.5 Ltr



ODIN COLLECTION



Odin oblong chafing dish with brass legs

Material: Stainless steel 18-10; Solid die casting handle and legs

Code: 1231D-B00

Size: L667 × W498 × H452 mm

Weight: 19.5 kg

Capacity: 8 Ltr



Odin round chafing dish with brass legs

Material: Stainless steel 18-10; Solid die casting handle and legs

Code: 1241D-B00

Size: L515 × W523 × H468 mm

Weight: 15 kg

Capacity: 6 Ltr



Odin round chafing dish with brass legs

Material: Stainless steel 18-10; Solid die casting handle and legs

Code: 1242D-B00

Size: L435 × W445 × H410 mm

Weight: 14 kg

Capacity: 4.5 Ltr



Odin oblong chafing dish with chrome legs

Material: Stainless steel 18-10; Solid die casting handle and legs

Code: 1231D-CHO

Size: L667 × W498 × H452 mm

Weight: 19.5 kg

Capacity: 8 Ltr



Odin round chafing dish with chrome legs

Material: Stainless steel 18-10; Solid die casting handle and legs

Code: 1241D-CHO

Size: L515 × W523 × H468 mm

Weight: 15 kg

Capacity: 6 Ltr



Odin round chafing dish with chrome legs

Material: Stainless steel 18-10; Solid die casting handle and legs

Code: 1242D-CHO

Size: L435 × W445 × H410 mm

Weight: 14 kg

Capacity: 4.5 Ltr



Odin oblong chafing dish drop-in

Material: Stainless steel 18-10; Solid die casting handle

Code: 1434D-000

Size: L667 × W475 × H410 mm

Weight: 12.80 kg

Capacity: 8 Ltr



Odin round chafing dish drop-in

Material: Stainless steel 18-10; Solid die casting handle

Code: 1444D-000

Size: L515 × W485 × H470 mm

Weight: 10.20 kg

Capacity: 6 Ltr



CONTEMPORARY COLLECTION



Contemporary oblong chafing dish

Material: Stainless steel 18-10

Code: 15410-000

Size: L650 x W415 x H440 mm

Weight: 11.7 kg

Capacity: 8 Ltr



WARM



Contemporary round chafing dish

Material: Stainless steel 18-10

Code: 15420-000

Size: L495 x W485 x H480 mm

Weight: 6.6 kg

Capacity: 6 Ltr



WARM



OUZI COLLECTION



Ouzi round chafing dish with wooden legs
 Material: Stainless steel 18-10; Black painted wooden legs
Code: 15430-B00
 Size: L725 x W830 x H505 mm
 Weight: 22 kg
 Capacity: 36 Ltr



WARM



Ouzi round chafing dish with chrome legs
 Material: Stainless steel 18-10; Mirror polished stainless steel legs
Code: 15430-CHO
 Size: L725 x W830 x H505 mm
 Weight: 28 kg
 Capacity: 36 Ltr



WARM



Customized Ouzi chafing dish trolley

Code: 15430-T00
 Is available on request.



Chafier not included.

MINI CHAFER COLLECTION



Odin mini sauce chafing dish with brass legs

Material: Stainless steel 18-10; Porcelain

Code: 12920-B00

Package: Porcelain tray included

Size: L235 x W235 x H310 mm

Weight: 4.2 kg

Capacity: 0.8 Ltr



Odin mini sauce chafing dish with chrome legs

Material: Stainless steel 18-10; Porcelain

Code: 12920-CHO

Package: Porcelain tray included

Size: L235 x W235 x H310 mm

Weight: 4.2 kg

Capacity: 0.8 Ltr



Mini chafing dish

Material: Stainless steel 18-10; Chrome plated brass pipe; Porcelain

Code: 12910-CHO

Package: Porcelain tray included

Size: L270 x W270 x H310 mm

Weight: 3.2 kg

Capacity: 0.8 Ltr



Domino sauce chafing dish

Material: Stainless steel 18-10; Porcelain; Corian

Package: Porcelain tray included

Code: 19401-180

Size: L250 x W250 x H312 mm

Weight: 5.56 kg

Capacity: 0.8 Ltr



Tiffany mini sauce chafer

Material: Stainless steel 18-10; Solid die casting handle; Porcelain

Code: 12921-000

Size: L227 x W224 x H323 mm

Weight: 2.7 kg

Capacity: 0.8 Ltr



Tiffani mini sauce chafer golden bell

Material: Stainless steel 18-10; Solid die casting handle; Rose gold PVD coated stainless steel dome cover; Porcelain

Code: 12921-001

Size: L224 x W224 x H494 mm

Weight: 2.65 kg

Capacity: 0.8 Ltr



Tiffani mini sauce chafer golden bell bronze vintage

Material: Stainless steel 18-10; Solid die casting handle; Bronze PVD coated stainless steel dome cover; Porcelain

Code: 12921-001-BRZ

Size: L224 x W224 x H494 mm

Weight: 2.65 kg

Capacity: 0.8 Ltr



NEW

ELECTRIC HEATERS

Equipped with temperature sensor which can detect accurate temperature.
Delay function to set the time of use. Overheating alarm system.



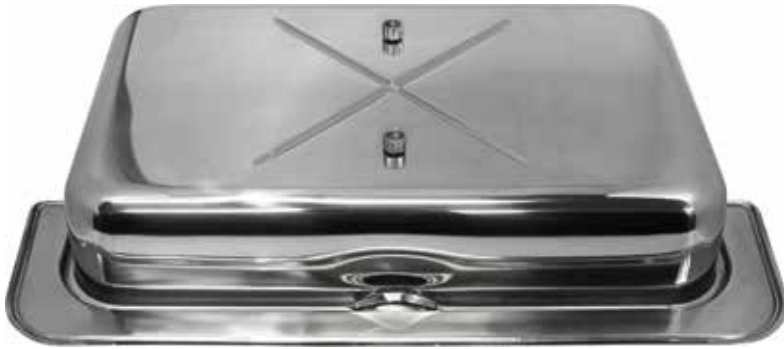

Spring electric heater with digital controller and temperature sensor

Material: Stainless steel frame; Aluminium sheathed; Ceramic coated die casting plate; PPS

Code: 11731-UGD

Rating: 230V, 50/60Hz, 400W

Size: L110 × W180 × H123 mm

Weight: 1.2 kg



Universal electric roll top chafing dish heater plate with digital controller and temperature sensor

Material: Aluminium sheathed; Ceramic coated die casting plate; PPS

Compatible with: oblong and round roll top chafing dishes

Code: 11722-000

Rating: 230V, 50/60Hz, 470W

Size: L200 × W235 × H37 mm

Weight: 1.48 kg





Chafing dishes accessories



ACCESSORIES

HOW TO MAKE SOUP STATION

With Tiger chafers, conventional chafers can transform into soup station as easy as ABC. Simply take out the food pan and insert the kit as indicated below.

1. Soup kit for round Induction chafing dish:
11228 (large) + 11500 (1 ea)
11238 (medium) + 11500 (1 ea)
2. Soup kit for round roll top chafing dish:
11228 (large) + 11500 (1 ea)
11238 (medium) + 11500 (1 ea)
3. Soup kit for oblong roll top chafing dish:
11118 + 11500 (2 ea)



Soup bucket with single wall

Material: Stainless steel 18-10

Code: 11500-000

Size: D240 x H214 mm

Weight: 0.92 kg

Capacity: 4.2 Ltr



Round soup station lid

Material: Stainless steel 18-10

Code: 11228-000

Size: D390 x H55 mm

Weight: 0.82 kg

Thickness: 1 mm



Round soup station lid

Material: Stainless steel 18-10

Code: 11238-000

Size: D328 x H60 mm

Weight: 0.7 kg

Thickness: 1 mm



Oblong soup station lid

Material: Stainless steel 18-10











Code: 11118-000

Size: L537 x W335 x H56 mm















Weight: 1.14 kg

Thickness: 1 mm













<p>Fuel holder cup Material: Stainless steel 18-10 Code: 11900-000 Size: L93 × W169.5 × H65.8 mm Weight: 0.12 kg</p> 	<p>Hinged soup bucket (4.2 Ltr) Material: Stainless steel 18-10 Code: 11500-500 Size: L237 × W254 × H209 mm Weight: 1.03 kg Capacity: 4.2 Ltr</p>  <p>HINGED</p>	<p>Soup bucket for 16500 (10 Ltr) Material: Stainless steel 18-10 Code: S1-16500-200 Size: L360 × W315 × H350 mm Weight: 1.95 kg Capacity: 10 Ltr</p> 	<p>Soup Bucket for 16800 (10 ltr) Material: Stainless steel 18-10 Code: K1-16800-230 Size: D287.9 × H210.7 mm Weight: 0.9 kg Capacity: 10 Ltr</p> 
<p>Smart serving spoon holder for smart round Material: Stainless steel 18-10 Code: 11268-000 Size: L220 × W118 × H35 mm Weight: 0.2 kg</p> 	<p>Smart serving spoon holder for smart square Material: Stainless steel 18-10 Code: 11269-000 Size: L240 × W110 × H35 mm Weight: 0.22 kg</p> 	<p>Detachable serving spoon holder for oblong roll top chafer Material: Stainless steel 18-10 Code: 11270-000 Size: L235 × W108 × H104 mm Weight: 0.26 kg Spoon not included</p> 	<p>Detachable serving spoon holder for round roll top chafer Material: Stainless steel 18-10 Code: 11271-000 Size: L220 × W116 × H104 mm Weight: 0.24 kg</p> 
<p>Smart W spoon holder Material: Stainless steel 18-10; Porcelain Code: 11272-000 Size: L150 × W131 × H87 mm Weight: 0.22 kg Spoon not included</p> 	<p>Smart W porcelain spoon holder Material: Porcelain Code: 11273-000 Size: L235 × W105 × H48 mm Weight: 0.28 kg</p> 	<p>Windguard round Material: Stainless steel 18-10 Code: 11914-000 Size: L140 × W120 × H77 mm Weight: 0.38 kg</p> 	<p>Windguard oblong Material: Stainless steel 18-10 Code: 11913-000 Size: L370 × W120 × H77 mm Weight: 0.6 kg</p> 



<p>Yogurt lid (28 holes) Material: Stainless steel 18-10 Code: 11512-000 Size: L480 × W287 × H10 mm Weight: 1.04 kg Package: 3 ea/set</p> 	<p>Ice pack Material: HDPE cylinder Code: 11511-000 Package: 2 ea Size: L255 × W200 × H30 mm Weight: 1 kg</p>  <p> COOL</p>	<p>Ice pack tray Material: Stainless steel 18-10 Code: 11513-ST5 Size: L495 × W300 × H55 mm Weight: 1.22 kg Capacity: 5 Ltr Thicknes: 1 mm</p>  <p> COOL</p>	<p>Adaptor ring for 10 cm depth food pan Material: Stainless steel 18-10 Code: 11119-000 Size: L460 × W410 × H80 mm Weight: 1.66 kg Thicknes: 1 mm</p> 
<p>Oblong food pan (GN 1/1) Material: Stainless steel 18-10 Code: 11101-070 Size: L530 × W325 × H65.5 mm Weight: 1.54 kg Capacity: 8 Ltr Thicknes: 1 mm</p> 	<p>Oblong food pan (GN 1/2, 1 ea) Material: Stainless steel 18-10 Code: 11102-000 Size: L265 × W325 × H65 mm Weight: 0.74 kg Capacity: 4 Ltr Thicknes: 0.7 mm</p> 	<p>Oblong food pan (GN 1/3, 1 ea) Material: Stainless steel 18-10 Code: 11103-000 Size: L176 × W325 × H65 mm Weight: 0.46 kg Capacity: 2.5 Ltr Thicknes: 0.7 mm</p> 	<p>Drip dish for 11103 Material: Stainless steel 18-10 Code: 11516-000 Size: L127 × W259 × H19.5 mm Weight: 0.35 kg (1 ea)</p> 
<p>Round food pan (large) Material: Stainless steel 18-10 Code: 11201-000 Size: D383 × H66 mm Weight: 1.28 kg Capacity: 6 Ltr Thicknes: 1 mm</p> 	<p>Round food pan (medium) Material: Stainless steel 18-10 Code: 11202-000 Size: D328 × H66 mm Weight: 0.98 kg Capacity: 4.5 Ltr Thicknes: 1 mm</p> 	<p>Round half food pan Material: Stainless steel 18-10 Code: 11221-HLF Package: 2 pcs/set Size: D385 × H68 mm Weight: 1.06 kg (1 ea) Capacity: 2.7 Ltr (1 ea) Thicknes: 1.2 mm</p> 	<p>Drip dish for 11221-HLF Material: Stainless steel 18-10 Code: 11517-000 Size: L140.5 × W314 × H25 mm Weight: 0.36 kg (1 ea)</p> 









<p>Oblong food pan (GN 2/3) Material: Stainless steel 18-10</p> <p>Code: 11104-000 Size: L335 × W325 × H65.5 mm Weight: 1.12 kg Capacity: 5.5 Ltr Thicknes: 1 mm</p> 	<p>Oblong food pan (GN 2/3) Material: Stainless steel 18-10</p> <p>Code: 11104-100 Size: L351 × W324 × H100 mm Weight: 0.75 kg Capacity: 8.5 Ltr Thicknes: 1 mm</p>  <p style="text-align: center;">NEW</p>	<p>Oblong S.S. food pan for Artisan (4.5Ltr) Material: Stainless steel 18-10</p> <p>Code: 11318-000 Size: L340 × W280 × H65 mm Weight: 0.95 kg Capacity: 4.5 Ltr Thicknes: 1 mm</p>  <p style="text-align: center;">NEW</p>	<p>Oblong food pan (GN 1/1) Material: Stainless steel 18-10</p> <p>Code: 11101-100 Size: L530 × W325 × H100 mm Weight: 1.80 kg Capacity: 12 Ltr Thicknes: 1 mm</p> 
--	---	--	--

<p>Oblong Water Pan (non-dripless) Material: Stainless steel 18-10</p> <p>Code: 11300-001 Size: L534 × W329 × H101 mm Weight: 1.94 kg Capacity: 15 Ltr Thicknes: 1 mm</p>  	<p>Round water pan (non-dripless) Material: Stainless steel 18-10</p> <p>Code: 11401-000 Size: D382 × H100 mm Weight: 1.52 kg Capacity: 10 Ltr Thicknes: 1 mm</p>  	<p>Round water pan (non-dripless) Material: Stainless steel 18-10</p> <p>Code: 11402-000 Size: D325 × H88.5 mm Weight: 1.22 kg Capacity: 6 Ltr Thicknes: 1 mm</p>  	<p>Round water pan (dripless) Material: Stainless steel 18-10</p> <p>Code: 11401-200 Size: L452 × W428 × H95 mm Weight: 1.74 kg Capacity: 9 Ltr Thicknes: 1 mm</p>  
--	--	---	---

<p>Oblong water pan (dripless) Material: Stainless steel 18-10</p> <p>Code: 11307-000 Size: L604 × W307 × H103 mm Weight: 2.25 kg Capacity: 14 Ltr Thicknes: 1 mm</p>  	
---	--























<p>Porcelain insert round (1/1) Material: Porcelain Code: 11204-000 Package: 3 ea/set Size: D388 × H66 mm Weight: 2.44 kg Capacity: 5 Ltr</p> 	<p>Porcelain insert round (1/1) Material: Porcelain Code: 11214-000 Package: 3 ea/set Size: D328 × H71 mm Weight: 2 kg Capacity: 3.5 Ltr</p> 	<p>Porcelain insert round (1/2) Material: Porcelain Code: 11205-000 Package: 3 ea/set Size: D388 × H66 mm Weight: 2.98 kg Capacity: 4 Ltr</p> 	<p>Porcelain insert round (1/2) Material: Porcelain Code: 11215-000 Package: 3 ea/set Size: D328 × H71 mm Weight: 1.96 kg Capacity: 2.6 Ltr</p> 
<p>Round divided porcelain insert (1/3) Material: Porcelain Code: 11217-000 Size: D388 × H66 mm Weight: 3.3 kg Capacity: 3 Ltr</p> 	<p>Porcelain insert (GN 1/1) Material: Porcelain Code: 11206-000 Package: 2 ea Size: L534 × W329 × H63 mm Weight: 5.1 kg Capacity: 7 Ltr</p> 	<p>Porcelain insert (GN 1/1) Material: Porcelain Code: 11206-250 Package: 3 ea Size: L500 × W306 × H33 mm Weight: 2.52 kg</p> 	<p>Porcelain insert (GN 1/2) Material: Porcelain Code: 11207-000 Package: 3 ea Size: L329 × W267 × H63 mm Weight: 3.6 kg Capacity: 4 Ltr</p> 
<p>Porcelain insert (GN 1/2) Material: Porcelain Code: 11207-250 Package: 3 ea Size: L252 × W306 × H33 mm Weight: 1.34 kg</p> 	<p>Porcelain insert (GN 1/3) Material: Porcelain Code: 11208-000 Package: 3 ea Size: L178 × W329 × H63 mm Weight: 1.8 kg Capacity: 2 Ltr</p> 	<p>Porcelain insert (GN 2/3) Material: Porcelain Code: 11209-209 Package: 3 ea Size: L329 × W355 × H63 mm Weight: 2.6 kg Capacity: 3 Ltr</p> 	<p>Mini chafer insert Material: Porcelain Code: 11216-000 Package: 3 ea Size: D208 × H60 mm Weight: 0.6 kg Capacity: 0.8 Ltr</p> 

CERAMIC COATED S.S. FOOD PANS

Unbreakable beauty!

1. Ceramic coated Stainless Steel food pan
2. Dish-washer safe
3. Compatible food pans for all the chafers











<p>Ceramic coated S.S. 18-10 oblong food pan (GN 1/1, 65 mm) Material: Stainless steel 18-10; Ceramic coated Code: 11310-WHT Size: L530 × W325 × H65.5 mm Weight: 1.65 kg Capacity: 8 Ltr</p>  	<p>Ceramic coated S.S. 18-10 oblong food pan (GN 1/1, 100 mm) Material: Stainless steel 18-10; Ceramic coated Code: 11311-WHT Size: L534 × W329 × H101 mm Thickness: 0.7 mm Weight: 1.45 kg Capacity: 15 Ltr</p>  	<p>Ceramic coated S.S. 18-10 oblong food pan (GN 1/2, 65 mm) Material: Stainless steel 18-10; Ceramic coated Code: 11312-WHT Size: L265 × W325 × H65 mm Weight: 0.65 kg Capacity: 4 Ltr</p>  	<p>Ceramic coated S.S. 18-10 oblong food pan (GN 1/3, 65 mm) Material: Stainless steel 18-10; Ceramic coated Code: 11313-WHT Size: L176 × W325 × H65 mm Weight: 0.5 kg Capacity: 4 Ltr</p>  
<p>Ceramic coated S.S. 18-10 oblong food pan (GN 2/3, 65 mm) Material: Stainless steel 18-10; Ceramic coated Code: 11314-WHT Size: L355 × W325 × H65.5 mm Weight: 1.15 kg Capacity: 5.5 Ltr</p>  	<p>Ceramic coated S.S. 18-10 round food pan (6 Ltr) Material: Stainless steel 18-10; Ceramic coated Code: 11315-WHT Size: D383 × H66 mm Weight: 1.25 kg Capacity: 6 Ltr</p>  	<p>Ceramic coated S.S. 18-10 round food pan (4.5 Ltr) Material: Stainless steel 18-10; Ceramic coated Code: 11316-WHT Size: D328 × H66 mm Weight: 0.95 kg Capacity: 4.5 Ltr</p>  	<p>Ceramic coated S.S. 18-10 round half food pan (2.7 Ltr) Material: Stainless steel 18-10; Ceramic coated Code: 11317-WHT Size: D385 × H68 mm Weight: 0.85 kg Capacity: 2.5 Ltr</p>  
<p>Ceramic coated S.S. 18-10 casting chafer food pan (GN 2/3) Material: Stainless steel 18-10; Ceramic coated Code: 11318-WHT Size: L340 × W280 × H65 mm Thickness: 1 mm Weight: 0.95 kg Capacity: 4.5 Ltr</p>  	<p>Silicone Serving Spoon Material: Silicone; Nylon Code: 11524-SET Package: 6 ea/set Size: L340.5 × W65.5 × H26.5 mm Weight: 0.15 kg (1 ea)</p>  <p>NEW</p>	 <p>• Elegant • resistant • dishwasher-safe & food safe</p> <p>Useful tips for ceramic coated food pan Warning : The use of metal spoon will seriously reduce the life cycle of the product. Manufacturer is not responsible for this defect.</p> <p>11524-SET Silicone Serving Spoon (340MM) (6pcs/Set)</p>	



SERVING SPOONS



<p>Shelly tong Material: Stainless steel 18-8 Code: 11506-000 Package: 6 ea/set Size: H250 mm Weight: 0.3 kg</p> 	<p>9.5" Spring tong Material: Stainless steel 18-8 Code: 11507-000 Package: 6 ea/set Size: H245 mm Weight: 0.22 kg</p> 	<p>Spaghetti tong Material: Stainless steel 18-8 Code: 11508-000 Package: 6 ea/set Size: H190 mm Weight: 0.16 kg</p> 	<p>Multi use tong Material: Stainless steel 18-10 Code: 11008-000 Size: L82 x W46 x H250 mm Weight: 0.13 kg</p> 
<p>Soup ladle Material: Stainless steel 18-8 Code: 11501-000 Package: 6 ea/set Size: H305 mm Weight: 0.22 kg</p> 	<p>Solid spoon Material: Stainless steel 18-8 Code: 11502-000 Package: 6 ea/set Size: H345 mm Weight: 0.25 kg</p> 	<p>Slotted spoon Material: Stainless steel 18-8 Code: 11503-000 Package: 6 ea/set Size: H345 mm Weight: 0.24 kg</p> 	<p>Meat fork Material: Stainless steel 18-8 Code: 11504 Package: 6 ea/set Size: H355 mm Weight: 0.22 kg</p> 
<p>Pasta ladle Material: Stainless steel 18-8 Code: 11505-000 Package: 6 ea/set Size: H350 mm Weight: 0.3 kg</p> 	<p>Soup ladle Material: Stainless steel 18-8 Code: 11523-000 Package: 6 ea/set Size: L90 x H310 mm Weight: 0.192 kg (1 ea)</p> 	<p>Cake server Material: Stainless steel 18-8 Code: 11522-000 Package: 6 ea/set Size: L53 x H246 mm Weight: 0.108 kg (1 ea)</p> 	<p>Silicone Serving Spoon Material: Silicone; Nylon Code: 11524-SET Package: 6 ea/set Size: L340.5 x W65.5 x H26.5 mm Weight: 0.15 kg (1 ea)</p> 

NEW

ACCESSORY COMPATIBILITY CHART

Category		INDUCTION CHAFING DISH: T-COLLECTION, SMART W, SMART				PREMIUM CASTING CHAFER: ARTISAN	
Shape		OBLONG (8Ltr)	SQUARE (5.5Ltr)	ROUND L (6Ltr)	ROUND M (4.5Ltr)	SQUARE (4.5Ltr)	ROUND (4.5Ltr)
Related Code No.		15706-135 15707-135	15800-CHO 1580-CHO-RGD 15800-CHO-BLK 15700-CHOB 15703-CHOB 15600-CHO 15600-000 15601-CHO 15601-000	15801-CHO 15801-CHO-RGD 15801-CHO-BLK 15702-CHOB 15704-CHOB 15300-CHO 15300-000 15301-CHO 15301-000	15702-CHOB 15705-CHOB 15302-CHO 15302-000 15303-CHO 15303-000	15900-000 15900-001 15900-002 15900-003	15901-000 15901-001 15901-002 15901-003
K1-16800-230	Soup Bucket for 16800 (10Ltr)						
S1-16500-200	Soup Bucket for 16500 (10Ltr)						
11500-000	Soup Bucket W/ Single Wall (4.2Ltr)	●		●	●		
11500-500	Hinged Soup Bucket (4.2Ltr)			●	●		
11228-000	Large-Round Soup Station Lid			●			
11238-000	Medium-Round Soup Station Lid				●		
11118-000	Oblong Soup Station Lid	●					
11119-000	Adaptor Ring for 10cm depth food Pan	●					
11913-000	Windgaurd Oblong						
11914-000	Windgaurd Round						
11102-000	Oblong Food pan (G/N, 1/2, 1EA)	●					
11103-000	Oblong Food pan (G/N, 1/3, 1EA)	●	● (2EA)				
11516-000	Drip dish for 11103 (1/3 GN)	●	●				
11104-000	Oblong Food Pan (G/N, 2/3)	●	●				
11318-000	Square Food Pan for Artisan Square (4.5Ltr)					●	
11101-070	Oblong Food pan (G/N, 1/1)	●					
11101-100	Oblong Food pan (100MM, G/N, 1/1)	●					
11201-000	Round Food Pan-Large			●			
11221-HLF	Round Half Food Pan Large (1/2, 2EA)			●			
11517-000	Drip Dish for 11221-HLF			●			
11202-000	Round Food Pan-Medium				●		●
11307-000	Oblong Water Pan (Dripless)						
11401-200	Round Water Pan (Dripless)						
11300-001	Oblong Water Pan (Non-Dripless)						
11401-000	Round Water Pan Large (Non-Dripless)						
11402-000	Round Water Pan Medium (Non-Dripless)						
11204-000	Porcelain Insert Round Large (1/1)			●			
11217-000	Round Divided Porcelain Insert Large (1/3)			●			
11205-000	Porcelain Insert Round Large (1/2)			●			
11214-000	Porcelain Insert Round Medium (1/1)				●		
11215-000	Porcelain Insert Round Medium (1/2)				●		
11206-000	Porcelain Insert (1/1)	●					
11207-000	Porcelain Insert (1/2)	●					
11208-000	Porcelain Insert (1/3)	●	●				
11209-209	Porcelain Insert (2/3)		●				
11216-000	Mini Chafer Insert						
11310-WHT	Ceramic Coated S.S. Food Pan (GN 1/1, 65MM)	●					
11311-WHT	Ceramic Coated S.S. Food Pan (GN 1/1, 100MM)	●					
11312-WHT	Ceramic Coated S.S. Food Pan (GN 1/2, 65MM)	●					
11313-WHT	Ceramic Coated S.S. Food Pan (GN 1/3, 65MM)	●	●				
11314-WHT	Ceramic Coated S.S. Food Pan (GN 2/3, 65MM)	●	●				
11315-WHT	Ceramic Coated S.S. Round Food Pan (6Ltr)			●			
11316-WHT	Ceramic Coated S.S. Round Food Pan (4.5 Ltr)				●		●
11317-WHT	Ceramic Coated S.S. Round Half Food Pan (2.7 Ltr)			●			
11318-WHT	Ceramic Coated S.S. Square Artisan Food Pan (4.5 Ltr)					●	

Category		SOUP URN		ROLL TOP CHAFING DISH: T-COLLECTION, IBIS, EURI, ODIN, CONTEMPORARY			MINI CHAFER
Shape		ROUND (10Ltr)		OBLONG (8Ltr)	ROUND L (6Ltr)	ROUND M (4.5Ltr)	ROUND (0.8 Ltr)
Related Code No.		16800-000	16500-000	17900-000 17510-000 1271D-B00 1271D-CHO 1231D-B00 1231D-CHO 1434D-000 15410-000	17910-000 17610-000 1281D-B00 1281D-CHO 1241D-B00 1241D-CHO 1444D-CHO 15420-000	17920-000 17710-000 1282D-B00 1282D-CHO 1242D-B00 1242D-CHO	12920-B00 12920-CHO 12910-CHO 19401-180 12921-000 12921-001 12921-100-BRZ
K1-16800-230	Soup Bucket for 16800 (10Ltr)	•					
S1-16500-200	Soup Bucket for 16500 (10Ltr)		•				
11500-000	Soup Bucket W/ Single Wall (4.2Ltr)			•	•	•	
11500-500	Hinged Soup Bucket (4.2Ltr)			•	•	•	
11228-000	Large-Round Soup Station Lid				•		
11238-000	Medium-Round Soup Station Lid					•	
11118-000	Oblong Soup Station Lid			•			
11119-000	Adaptor Ring for 10cm depth food Pan			•			
11913-000	Windgaurd Oblong			•			
11914-000	Windgaurd Round				•	•	
11102-000	Oblong Food pan (G/N, 1/2, 1EA)			•			
11103-000	Oblong Food pan (G/N, 1/3, 1EA)			•			
11516-000	Drip dish for 11103 (1/3 GN)			•			
11104-000	Oblong Food Pan (G/N, 2/3)			•			
11318-000	Square Food Pan for Artisan Square (4.5Ltr)						
11101-070	Oblong Food pan (G/N, 1/1)			•			
11101-100	Oblong Food pan (100MM, G/N, 1/1)			•			
11201-000	Round Food Pan-Large				•		
11221-HLF	Round Half Food Pan Large (1/2, 2EA)				•		
11517-000	Drip Dish for 11221-HLF				•		
11202-000	Round Food Pan-Medium					•	
11307-000	Oblong Water Pan (Dripless)			•			
11401-200	Round Water Pan (Dripless)				•		
11300-001	Oblong Water Pan (Non-Dripless)			• (15410-000)			
11401-000	Round Water Pan Large (Non-Dripless)				• (15420-000)		
11402-000	Round Water Pan Medium (Non-Dripless)					•	
11204-000	Porcelain Insert Round Large (1/1)				•		
11217-000	Round Divided Porcelain Insert Large (1/3)				•		
11205-000	Porcelain Insert Round Large (1/2)				•		
11214-000	Porcelain Insert Round Medium (1/1)					•	
11215-000	Porcelain Insert Round Medium (1/2)					•	
11206-000	Porcelain Insert (1/1)			•			
11207-000	Porcelain Insert (1/2)			•			
11208-000	Porcelain Insert (1/3)			•			
11209-209	Porcelain Insert (2/3)			•			
11216-000	Mini Chafer Insert						•
11310-WHT	Ceramic Coated S.S. Food Pan (GN 1/1, 65MM)			•			
11311-WHT	Ceramic Coated S.S. Food Pan (GN 1/1, 100MM)			•			
11312-WHT	Ceramic Coated S.S. Food Pan (GN 1/2, 65MM)			•			
11313-WHT	Ceramic Coated S.S. Food Pan (GN 1/3, 65MM)			•			
11314-WHT	Ceramic Coated S.S. Food Pan (GN 2/3, 65MM)			•			
11315-WHT	Ceramic Coated S.S. Round Food Pan (6Ltr)				•		
11316-WHT	Ceramic Coated S.S. Round Food Pan (4.5 Ltr)					•	
11317-WHT	Ceramic Coated S.S. Round Half Food Pan (2.7 Ltr)				•		
11318-WHT	Ceramic Coated S.S. Square Artisan Food Pan (4.5 Ltr)						



Urns and dispensers



The cereal dispenser is designed to dispense many different dry foods such as: Nuts, goldfish, trail mix, candy, yogurt toppings and of course cereal. Simply turn the soft rubber paddle with the handle to dispense. There is a catch tray at the bottom for crumbs. It can be easily assembled and disassembled so its simple to clean and repair. Replacement parts are readily available. This makes it a quality investment that will last for years to come. Made of 18-10 Stainless steel. The Dispenser cylinders are made of polycarbonate. Dishwasher safe. Outstanding scratch resistance and no glazing. Bisphenol A (BPA) Free. Juice Dispenser has a removable stainless steel ice core that fits onto the edge of the acrylic jar. The interior ridge of the acrylic jar flares, making the jar stronger. It has a removable drip tray for easy cleaning. Replacement parts are also available, so the juice dispenser is 100% repairable.

Coffee urns are designed to look great and be simple and easy to clean or service. With our optional electric heater, you can keep the coffee at a perfect temperature without it burning or scorching. It's made out of 18/10 stainless steel & comes with an insulated lid.

SMART W SOUP URNS

This 10 Liter capacity of soup urn is equipped with clad bottom, which works on the induction hob with 98% of responsiveness. With the stand, heating methods becomes even more versatile. Like any of our induction chafers, sterno or electric spring heater (11731-DGT) can be used.

Everlasting hydraulic hinge enables the one-hand operation to serve the food while keeping the soup warm and moisture. Modern and fun design of Smart W ranges has been completed with the arrival of soup urn.



Smart W soup urn with glass lid (10 Ltr)

Material: Stainless steel 18-10; Tempered glass

Code: 16800-000

Size: L474 x W434 x H303 mm

Capacity: 10 Ltr

Weight: 7 kg

Compatible with: Smart W round stand 11264; Soup bucket K1-16800-230



Smart W round stand

Material: Stainless steel 18-10; Solid die casting legs; Silicone

Code: 11263-000

Size: L350 x W440 x H140 mm

Weight: 3.6 kg

Compatible with: 15701; 15704

Code: 11264-000

Size: L300 x W420 x H140 mm

Weight: 3.5 kg

Compatible with: 15702; 15705; Soup Urn 16800



ODIN SOUP AND COFFEE URNS



Odin soup urn with brass legs (10 Ltr)
 Material: Stainless steel 18-10; Solid die casting handle and legs
Code: 16500-B00
 Size: L352 x W320 x H500 mm
 Weight: 8.02 kg
 Capacity: 10 Ltr
 Compatible with: Soup bucketlet S1-16500-200



Odin soup urn with chrome legs (10 Ltr)
 Material: Stainless steel 18-10; Solid die casting handle and legs
Code: 16500-CHO
 Size: L352 x W320 x H500 mm
 Weight: 8.02 kg
 Capacity: 10 Ltr



Odin coffee urn (3 gal) with brass legs
 Material: Stainless steel 18-10; Solid die casting handle and Legs
Code: 16330-B00
 Size: L315 x W315 x H575 mm
 Weight: 7.6 kg
 Capacity: 12 Ltr



Odin coffee urn (3 gal) with chrome legs
 Material: Stainless steel 18-10; Solid die casting handle and Legs
Code: 16330-CHO
 Size: L315 x W315 x H575 mm
 Weight: 7.6 kg
 Capacity: 12 Ltr



Odin coffee urn (5 gal) with brass legs
 Material: Stainless steel 18-10; Solid die casting handle and legs
Code: 16350-B00
 Size: L325 x W325 x H690 mm
 Weight: 8.3 kg
 Capacity: 19 Ltr



Odin coffee urn (5 gal) with chrome legs
 Material: Stainless steel 18-10; Solid die casting handle and legs
Code: 16350-CHO
 Size: L325 x W325 x H690 mm
 Weight: 8.3 kg
 Capacity: 19 Ltr



EURI COFFEE URNS



Euri coffee urn (3 gal) with brass legs

Material: Stainless steel 18-10

Code: 16360-B00

Size: L315 x W315 x H575 mm

Weight: 7.6 kg

Capacity: 12 Ltr



WARM



Euri coffee urn (3 gal) with chrome legs

Material: Stainless steel 18-10

Code: 16360-CHO

Size: L315 x W315 x H575 mm

Weight: 7.6 kg

Capacity: 12 Ltr



WARM



Euri coffee urn (5 gal) with brass legs

Material: Stainless steel 18-10

Code: 16370-B00

Size: L320 x W320 x H690 mm

Weight: 8.3 kg

Capacity: 19 Ltr



WARM



Euri coffee urn (5 gal) with chrome legs

Material: Stainless steel 18-10

Code: 16370-CHO

Size: L320 x W320 x H690 mm

Weight: 8.3 kg

Capacity: 19 Ltr



WARM



IBIS COFFEE URNS



Ibis coffee urn (1 gal)

Material: Stainless steel 18-10

Code: 16340-000

Size: L228.6 × W266 × H388 mm

Weight: 3.17 kg

Capacity: 4.5 Ltr



WARM



DISPENSER SETS



Borosilicate glass juice set (3 cylinder)

Material: Borosilicate glass; Stainless steel 18-10; PMMA (Acrylic); ABS (chrome plated); Silicone

Code: 40021-000

Size: L505 × W176 × H337 mm

Weight: 3.38 kg

Capacity: 1.2 Ltr (1 cylinder)



Borosilicate glass cereal set (3 cylinder)

Material: Glass, Stainless steel 18-10; PMMA (Acrylic); ABS (chrome plated); Silicone

Code: 40022-000

Size: L505 × W176 × H337 mm

Weight: 3.38 kg

Capacity: 1.2 Ltr (1 cylinder)





Borosilicate glass juice set (3 cylinder)

Material: Borosilicate glass; Ashwood; ABS (chrome plated); Silicone

Code: 40021-ASH

Size: L414 × W158 × H340.5 mm

Weight: 2.55 kg

Capacity: 1.2 Ltr (1 cylinder)



Borosilicate glass cereal set (3 cylinder)

Material: Borosilicate glass; Ashwood; ABS (chrome plated); Silicone

Code: 40022-ASH

Size: L414 × W158 × H340.5 mm

Weight: 2.55 kg

Capacity: 1.2 Ltr (1 cylinder)



T-COLLECTION DISPENSERS







T-Collection glass container juice dispenser (single)

Material: Stainless steel 18-10; Powder coated steel pipe (black); Ashwood (gray); Tempered glass; Silicone
Ice core included

Code: 18005-000
Size: L287.5 x W296.2 x H523
Weight: 5.15 kg
Capacity: 5.7 Ltr



NEW

T-Collection glass container juice dispenser (double)

Material: Stainless steel 18-10; Powder coated steel pipe (black); Ashwood (gray); Tempered glass; Silicone
Ice core included

Code: 18006-000
Size: L574.5 x W296.2 x H523
Weight: 9.88 kg
Capacity: 11.4 Ltr



NEW

Acrylic diffuser core

Material: PMMA (Acrylic), Silicone

Code: 18005-200
Size: D130 x H270 mm
Weight: 0.31 kg
Capacity: 0.7 Ltr
Diffuser optional



Acrylic ice core

Material: PMMA (Acrylic), Silicone

Code: 18005-100
Size: D130 x H270 mm
Weight: 0.33 kg
Capacity: 0.7 Ltr
Spare part



T-Collection cereal dispenser

Material: Stainless steel 18-10; Powder coated steel; Ashwood; PP; Silicone; POM; Solid die casting
Ice core included

Code: 18430-000
Size: L160 x W216.8 x H632.8
Weight: 5.4 kg
Capacity: 3 Ltr



T-Collection cereal dispenser container

Material: Ashwood; Chestnut wood; PMMA (Acrylic); Powder coated steel pipe(black)

Code: 18007-000
Size: L530.5 x W162.5 x H278 mm
Weight: 3.95 kg
Capacity: 2 Ltr x 3ea (6 Ltr)



T-Collection cereal container with cover

Material: Ashwood

Code: 18007-100
Size: L130 x W130 x H125 mm



T-Collection cereal dispenser stand

Material: Ashwood; Powder coated steel pipe(black)

Code: 18007-200
Size: L530.5 x W162.5 x H120 mm
Weight: 1.5 kg



T-Collection cereal dispenser spoon

Material: Wood

Code: 18007-300
Size: L63 x H220 mm
Weight: 0.04 kg





T-Collection square juice dispenser 7 Ltr
 Material: Stainless steel 18-10; Powder coated steel pipe(black); PMMA (Acrylic); Silicone
Code: 18008-000
 Size: L286.5 x W392.3 x H399 mm
 Weight: 5.55 kg
 Capacity: 7 Ltr



Ice core and drip tray included

NEW

T-Collection square juice dispenser 15 Ltr
 Material: Stainless steel 18-10; Powder coated steel pipe(black); PMMA (Acrylic); Silicone
Code: 18009-000
 Size: L286.5 x W392.3 x H661 mm
 Weight: 8.05 kg
 Capacity: 15 Ltr



Ice core and drip tray included

NEW

Universal drip tray for juice dispenser
 Material: Stainless steel 18-10; Silicone
Code: 18008-300
 Size: L107.9 x W107.9 x H16.5 mm
 Weight: 0.35 kg



NEW

Ice core for 18008-000
 Material: PMMA (Acrylic)
Code: 18008-100
 Size: L70 x W90 x H172 mm
 Weight: 0.19 kg
 Capacity: 0.67 Ltr



NEW

Diffuser for 18008-000
 Material: PMMA (Acrylic)
Code: 18008-200
 Size: L70 x W90 x H172 mm
 Weight: 0.18 kg
 Capacity: 0.67 Ltr



NEW

Ice core for 18009-000
 Material: PMMA (Acrylic)
Code: 18009-100
 Size: L70 x W90 x H400 mm
 Weight: 0.39 kg
 Capacity: 1.6 Ltr



NEW

Diffuser for 18009-000
 Material: PMMA (Acrylic)
Code: 18009-200
 Size: L70 x W90 x H400 mm
 Weight: 0.37 kg
 Capacity: 1.6 Ltr



NEW

T-Collection cereal dispenser bronze vintage
 Material: Stainless steel 18-10; Powder coated steel (black); Ashwood; PP; Silicone; POM; Solid die casting; Bronze PVD coated
Code: 18430-000-BRZ
 Size: L160 x W216.8 x H632.8
 Weight: 5.4 kg
 Capacity: 3 Ltr



NEW

HI-LINE DISPENSERS



Hi-line milk dispenser

Material: Stainless steel 18-10; PMMA (Acrylic) stand

Code: **18921-IWS**

Size: L375 x W235 x H480 mm

Weight: 4.5 kg

Capacity: 5 Ltr



COOL



Hi-line juice dispenser

Material: Stainless steel 18-10; Polycarbonate cylinder; PMMA (Acrylic) stand

Code: **18912-IWS**

Size: L375 x W210 x H620 mm

Weight: 5 kg

Capacity: 7 Ltr



COOL



Hi-line cereal dispenser

Material: Stainless steel 18-10; Polycarbonate cylinder; PMMA (Acrylic) stand

Code: **18913-IWS**

Size: L220 x W210 x H610 mm

Weight: 2 kg

Capacity: 3.7 Ltr



COOL



EURI DISPENSERS



Euri juice dispenser (1.8 gal) with brass legs

Material: Stainless steel 18-10; Polycarbonate cylinder;
Solid die casting

Code: 18610-B00

Size: L285 × W285 × H590 mm

Weight: 6.5 kg

Capacity: 7 Ltr



Euri juice dispenser (1.8 gal) with chrome legs

Material: Stainless steel 18-10; Polycarbonate cylinder; Solid
die casting

Code: 18610-CHO

Size: L285 × W285 × H590 mm

Weight: 6.5 kg

Capacity: 7 Ltr



ODIN DISPENSERS



Odin juice dispenser (1.8 gal)

Material: Stainless steel 18-10; Polycarbonate cylinder; Solid die casting base

Code: 18001-000

Size: L325 x W195 x H560 mm

Weight: 5 kg

Capacity: 7 Ltr



Odin juice dispenser (1 gal)

Material: Stainless steel 18-10; Polycarbonate cylinder; Solid die casting base

Code: 18003-000

Size: L325 x W200 x H460 mm

Weight: 4.3 kg

Capacity: 3.7 Ltr



Odin milk dispenser

Material: Stainless steel 18-10; Solid die casting base

Code: 18710-000

Size: L325 x W200 x H430 mm

Weight: 4.6 kg

Capacity: 5 Ltr





Odin cereal dispenser (single)

Material: Stainless steel 18-10; Polycarbonate cylinder;
Solid die casting base

Code: 18310-000

Size: L265 × W200 × H595 mm

Weight: 3.3 kg

Capacity: 3.7 Ltr



Odin cereal dispenser (double)

Material: Stainless steel 18-10; Polycarbonate cylinder;
Solid die casting base

Code: 18410-000

Size: L215 × W310 × H595 mm

Weight: 5.2 kg

Capacity: 3.7 Ltr (1 ea)



Odin cereal dispenser (triple)

Material: Stainless steel 18-10; Polycarbonate cylinder;
Solid die casting base

Code: 18420-000

Size: L265 × W265 × H595 mm

Weight: 6.7 kg

Capacity: 3.7 Ltr (1 ea)







WOOD COLLECTION DISPENSERS



Juice dispenser with wooden base
Material: Wood; 18-10 S.S; Polycarbonate cylinder
Code: 19403-NAT (natural)
Size: L344 x W223 x H490 mm
Capacity: 3.8 Ltr



Juice dispenser with wooden base
Material: Wood; 18-10 S.S; Polycarbonate cylinder
Code: 19403-NOC (walnut)
Size: L344 x W223 x H490 mm
Capacity: 3.8 Ltr



Juice dispenser with wooden base
Material: Wood; 18-10 S.S; Polycarbonate cylinder
Code: 19403-NER (black)
Size: L344 x W223 x H490 mm
Capacity: 3.8 Ltr





Milk dispenser with wooden base

Material: Wood; 18-10 S.S

Code: 18710-NAT (natural)

Size: L335 x W192 x H460 mm

Capacity: 5 Ltr



Milk dispenser with wooden base

Material: Wood; 18-10 S.S

18710-NOC (walnut)

Size: L335 x W192 x H460 mm

Capacity: 5 Ltr



Milk dispenser with wooden base

Material: Wood; 18-10 S.S

18710-NER (black)

Size: L335 x W192 x H460 mm

Capacity: 5 Ltr





Buffet presentation



Tiger's new hollow ware and small ware are exclusively born from craftsmanship of Italian design master Giuliano Malimpensa. He has been designing and manufacturing Interior objects and retail items for over 40 years and has won worldwide recognition for his unique work. The synergy between his design experience and Tiger's diligent manufacturing has created practical professional products with a touch of elegance and class.

Tiger guarantees the premium quality with selection of high quality material and its products comply with the strictest European and American standards.





STANDS AND RISERS



Three nesting risers to save space and to provide elegant elevation.



T-Collection steel riser (1 tier)
Material: Powder coated steel pipe (black)
Code: 19940-001
Size: L325 x W265 x H103 mm
Weight: 0.87 kg



T-Collection steel riser (inclined)
Material: Powder coated steel pipe (black)
Code: 19940-002
Size: L325 x W265 x H197 mm
Weight: 0.96 kg



T-Collection steel riser (2 tiers)
Material: Powder coated steel pipe (black)
Code: 19940-003
Size: L355 x W265 x H253 mm
Weight: 1.11 kg



T-Collection steel riser (3 tiers)
Material: Powder coated steel pipe (black)
Code: 19940-004
Size: L385 x W265 x H403 mm
Weight: 1.25 kg



T-Collection steel riser (3 tiers set)
Material: Powder coated steel pipe (black)
Code: 19940-005
Size: L385 x W265 x H403 mm
Weight: 3.24 kg



T-Collection ice white Lucite tray
Material: PMMA (Acrylic)
Code: 19119-000
Size: L325 x W265 x H75 mm
Weight: 1.79 kg



T-Collection gray ashwood tray
Material: Ashwood
Code: 19117-400
Size: L325 x W265 x H40 mm
Weight: 0.56 kg



STACKABLE



T-Collection gray ashwood tray
Material: Ashwood
Code: 19117-750
Size: L325 x W265 x H75 mm
Weight: 0.68 kg



STACKABLE





T-Collection steel riser bronze vintage (1 tier)
Material: Powder coated steel pipe (bronze)

Code: 19940-001-BRZ
Size: L325 x W265 x H103 mm
Weight: 0.87 kg



NEW

T-Collection steel riser bronze vintage (inclined)
Material: Powder coated steel pipe (bronze)

Code: 19940-002-BRZ
Size: L325 x W265 x H197 mm
Weight: 0.96 kg



NEW

T-Collection steel riser bronze vintage (2 tiers)
Material: Powder coated steel pipe (bronze)

Code: 19940-003-BRZ
Size: L355 x W265 x H253 mm
Weight: 1.11 kg



NEW

T-Collection steel riser bronze vintage (3 tiers)
Material: Powder coated steel pipe (bronze)

Code: 19940-004-BRZ
Size: L385 x W265 x H403 mm
Weight: 1.25 kg



NEW

T-Collection steel riser bronze vintage (3 tiers set)
Material: Powder coated steel pipe (bronze)

Code: 19940-005-BRZ
Size: L385 x W265 x H403 mm
Weight: 3.24 kg



NEW

T-Collection wooden cold display (GN 1/2)

Material: Stainless steel 18-10; PMMA (Acrylic); Ashwood; HDPE; Silicone
Code: 18931-002
Size: L325 x W265 x H160 mm
Weight: 4.10 kg



NEW

T-Collection Acrylic Dome Cover (GN 1/2)

Material: Stainless steel 18-10; PMMA (Acrylic)
Code: 19946-002
Size: L302 x W244 x H150 mm
Weight: 1.25 kg

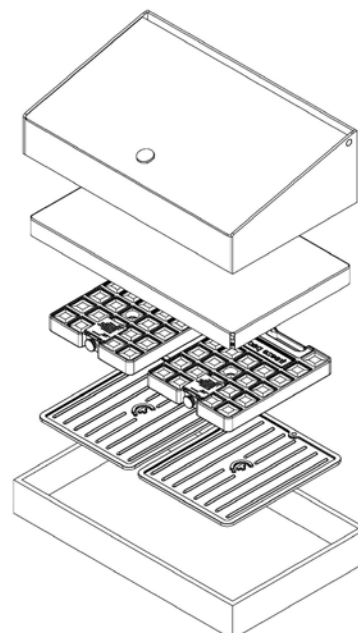



Compatible with G/N size porcelain inserts.



T-Collection steel riser (1 tier)
Material: Powder coated steel pipe (black)
Code: 19938-001
Size: L530 × W325 × H103 mm
Weight: 1.16 kg



T-Collection steel riser (inclined)
Material: Powder coated steel pipe (black)
Code: 19938-002
Size: L530 × W325 × H218 mm
Weight: 1.25 kg

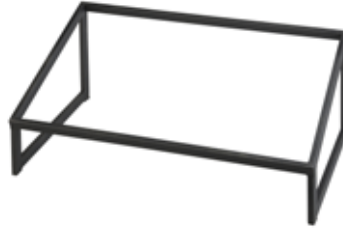

T-Collection steel riser (2 tiers)
Material: Powder coated steel pipe (black)
Code: 19938-003
Size: L560 × W325 × H253 mm
Weight: 1.28 kg

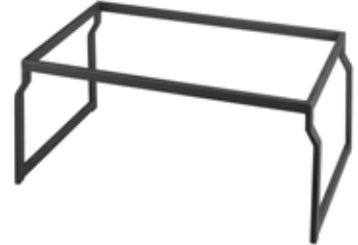

T-Collection steel riser (3 tiers)
Material: Powder coated steel pipe (black)
Code: 19938-004
Size: L590 × W325 × H403 mm
Weight: 1.64 kg



T-Collection steel riser (3 tiers, set)
Material: Powder coated steel pipe (black)
Code: 19938-005
Size: L590 × W325 × H403 mm
Weight: 4.09 kg

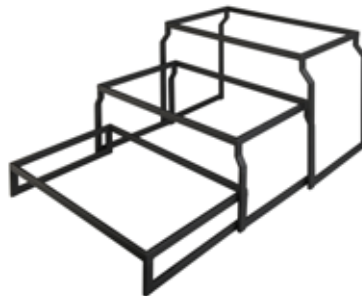

T-Collection ice white Lucite tray
Material: PMMA (Acrylic)
Code: 19118-000
Size: L530 × W325 × H75 mm
Weight: 3.16 kg



T-Collection gray ashwood tray
Material: Ashwood
Code: 19115-400
Size: L530 × W325 × H40 mm
Weight: 1.00 kg



STACKABLE



T-Collection gray ashwood tray
Material: Ashwood
Code: 19115-750
Size: L530 × W325 × H75 mm
Weight: 1.32 kg



STACKABLE





T-Collection steel riser bronze vintage (1 tier)
Material: Powder coated steel pipe (bronze)

Code: 19938-001-BRZ
Size: L530 × W325 × H103 mm
Weight: 1.16 kg



NEW

T-Collection steel riser bronze vintage (inclined)
Material: Powder coated steel pipe (bronze)

Code: 19938-002-BRZ
Size: L530 × W325 × H218 mm
Weight: 1.25 kg



NEW

T-Collection steel riser bronze vintage (2 tiers)
Material: Powder coated steel pipe (bronze)

Code: 19938-003-BRZ
Size: L560 × W325 × H253 mm
Weight: 1.28 kg



NEW

T-Collection steel riser bronze vintage (3 tiers)
Material: Powder coated steel pipe (bronze)

Code: 19938-004-BRZ
Size: L590 × W325 × H403 mm
Weight: 1.64 kg



NEW

T-Collection steel riser bronze vintage (3tier, set)
Material: Powder coated steel pipe (bronze)

Code: 19938-005-BRZ
Size: L590 × W325 × H403 mm
Weight: 4.09 kg



NEW

T-Collection cold display (GN 1/1)

Material: Stainless steel 18-10; PMMA (Acrylic); Ashwood; HDPE; Silicone

Code: 18931-001
Size: L530 × W325 × H160 mm
Weight: 7.45 kg



NEW

T-Collection Acrylic Dome Cover (GN 1/1)

Material: Stainless steel 18-10; PMMA (Acrylic)

Code: 19946-001
Size: L507 × W304 × H150 mm
Weight: 2.05 kg



NEW

Multi silicone pad

Material: Silicone









Code: 18931-100
Size: L224 × W284 × H6 mm
Weight: 0.27 kg
Package: 2 ea/set



NEW





<p>T-Collection steel riser Material: Powder coated steel pipe (black) Code: 19939-001 Size: L530 x W162 x H103 mm Weight: 0.87 kg</p> 	<p>T-Collection steel riser bronze vintage Material: Powder coated steel pipe (bronze) Code: 19939-001-BRZ Size: L530 x W162 x H103 mm Weight: 0.87 kg</p>  <p></p> <p>NEW</p>	<p>T-Collection steel riser (inclined) Material: Powder coated steel pipe (black) Code: 19939-002 Size: L530 x W162 x H162 mm Weight: 0.92 kg</p> 
<p>T-Collection steel riser bronze vintage (inclined) Material: Powder coated steel pipe (bronze) Code: 19939-002-BRZ Size: L530 x W162 x H162 mm Weight: 0.92 kg</p>  <p></p> <p>NEW</p>	<p>T-Collection gray ashwood tray Material: Ashwood Code: 19116-400 Size: L530 x W162 x H40 mm Weight: 0.55 kg</p> <p> STACKABLE</p> 	



T-Collection buffet stand set
 Material: Powder coated steel pipe (black)
Code: 19944-000
 Package: 3 pcs/set
 Size: L190 × W190 × H170 mm
 L225 × W225 × H205 mm
 L300 × W300 × H225 mm
 Weight: 0.55 kg | 0.7 kg | 0.9 kg



Tiffany buffet stand set
 Material: Stainless steel 18-10
Code: 19934-000
 Package: 3 pcs/set
 Size: D300(260) × H254 mm
 D224(205) × H205 mm
 D190(165) × H169.5 mm



Wire buffet stand
 Material: Stainless steel 18-10
Code: 19933-000
 Package: 2 pcs/set
 Size: L258 × W172 × H150 (Φ8.0 mm)
 L158 × W103 × H90.3 (Φ8.0 mm)
 Weight: 0.42 kg | 0.25 kg

















Cross buffet stand (3 heights)
 Material: PMMA (Acrylic)
Code: 19936-000
 Size: L150 × W150 × H180 mm
 L200 × W200 × H240 mm
 L200 × W200 × H300 mm
 Weight: 0.55 kg | 0.97 kg | 1.27 kg



DISPLAYS



<p>Hi-line cold display Material: Stainless steel 18-10; PC (polycarbonate) dome cover; HDPE ice pack; PMMA (Acrylic) stand</p> <p>Code: 18911-IWS Size: L596 × W416 × H285 mm Weight: 10.10 kg</p> <p> </p> 	<p>C2 cold display Material: Stainless steel 18-10; PC (polycarbonate) dome cover; HDPE ice pack</p> <p>Code: 18919 Size: L653 × W390 × H281 mm Weight: 10.5 kg</p> <p> </p> 	<p>Swatch cold display (metal) Material: Stainless steel 18-10; PC (polycarbonate) dome cover; HDPE ice pack</p> <p>Code: 18920-MTL Size: L608 × W433 × H284.4 mm Weight: 11.9 kg</p> <p> </p> 
<p>PC dome cover Material: Stainless steel 18-10; PC (polycarbonate)</p> <p>Code: 19927-BOM Size: L575 × W353.5 × H216.8 mm Weight: 1.94 kg</p> 	<p>Porcelain tray (GN 1/1) Material: Porcelain</p> <p>Code: 11206-250 Package: 3 ea Size: L500 × W306 × H33 mm Weight: 2.52 kg</p> 	<p>Porcelain tray (GN 1/2) Material: Porcelain</p> <p>Code: 11207-250 Package: 3 ea Size: L252 × W306 × H33 mm Weight: 1.34 kg</p> 
<p>Ice pack Material: HDPE</p> <p>Code: 11511-000 Package: 2 ea Size: L250 × W200 × H30 mm Weight: 1 kg</p> 	<p>Yogurt lid (28 holes) Material: Stainless steel 18-10; Silicone</p> <p>Code: 11512-000 Package: 3 ea/set Size: L468 × W275 × H10 mm Weight: 2.52 kg</p> 	<p>S.S. G/N tray without handle Material: Stainless steel 18-10</p> <p>Code: 18100-000 Package: 3 ea Size: L526 × W325 × H16 mm Weight: 2.02 kg</p> 

TRAYS



S.S. tray without handle
 Material: Stainless steel 18-10
Code: 18101-000
 Size: L570 x W425 x H18 mm
 Weight: 2.84 kg



S.S. tray without handle
 Material: Stainless steel 18-10
Code: 18102-000
 Size: L680 x W505 x H18 mm
 Weight: 4.02 kg



Round S.S. Tray
 Material: Stainless steel 18-10
Code: 18103-000
 Size: D420 mm
 Weight: 1.59 kg
Code: 18104-000
 Size: D380 mm
 Weight: 2.23 kg
Code: 18105-000
 Size: D300 mm
 Weight: 3.18 kg



NEW

S.S. tray with handle
 Material: Stainless steel 18-10; Solid die casting handl
Code: 18100-HDL
 Size: L526 x W325 x H48 mm
 Weight: 2.54 kg



STACKABLE



S.S. tray with handle
 Material: Stainless steel 18-10; Solid die casting handle
Code: 18101-HDL
 Size: L570 x W425 x H48 mm
 Weight: 3.9 kg



STACKABLE



S.S. tray with handle
 Material: Stainless steel 18-10; Solid die casting handle
Code: 18102-HDL
 Size: L680 x W505 x H48 mm
 Weight: 4.86 kg



STACKABLE





Multi use tray

Material: Stainless steel 18-10

Code: 19008-100

Size: L499.5 x W304.4 x H26 mm

Weight: 1.95 kg

Code: 19008-200

Multi use tray

Size: L554.5 x W384.4 x H26 mm

Weight: 2.71 kg



Buffet tray with black handle 45 mm depth

Material: Stainless steel 18-10; PMMA (Acrylic)

Code: 19009-000

Size: L610 x W333 x H45 mm

Weight: 2.44 kg



Buffet trays with black handle

Material: Stainless steel 18-10; PMMA (Acrylic)

Code: 40016-100

Size: L548.8 x W299.8 x H22.3 mm

Weight: 1.59 kg

Code: 40016-200

Size: L592 x W399 x H22.3 mm

Weight: 2.23 kg

Code: 40016-300

Size: L702 x W479 x H22.3 mm

Weight: 3.18 kg



BOWLS



Cloud buffet trays

Material: Stainless steel 18-10

Code: 40015-100

Size: D330 × H80 mm (1.2 T)

Weight: 0.4 kg

Code: 40015-200

Size: D580 × H80 mm (1.2 T)

Weight: 0.64 kg

Code: 40015-100-RGD (rose gold)

Size: D580 × H80 mm (1.2 T)

Weight: 0.64 kg



Square buffet bowl

Material: Stainless steel 18-10

Code: 19002-100

Size: D340 × H64 mm

Weight: 0.70 kg

Code: 19002-200

Size: D405 × H98 mm

Weight: 0.85 kg



Crescent bowl

Material: Stainless steel 18-10; Solid die casting

Code: 40019-100

Size: L220 × W105 × H77 mm

Weight: 0.18 kg

Code: 40019-200

Size: L420 × W220 × H150 mm

Weight: 0.73 kg



Crescent bowl with handle

Material: Stainless steel 18-10; Aluminum alloys (chrome plated); Solid die casting

Code: 40019-300

Size: L220 × W105 × H131 mm

Weight: 0.28 kg

Code: 40019-400

Size: L420 × W220 × H287.5 mm

Weight: 0.96 kg



Moon fruit tray

Material: Stainless steel 18-10

Code: 19001-000

Size: D389 × H296.8 mm

Weight: 1.7 kg



Relish dish-3 compartment

Material: Stainless steel 18-10; Aluminum alloys (chrome plated)

Code: 40023-000

Size: L178 × W166 × H132.6 mm

Weight: 0.45 kg

Capacity: 0.2 Ltr (1 compartment)



Odin swivel fruit dispenser

Material: Stainless steel 18-10; Aluminum alloys (chrome plated)

Code: 18510-000

Size: D328 × H565 mm

Weight: 4.5 kg







STANDS



Pastry stand (1 tier)

Material: Stainless steel 18-10; Solid die casting

Code: 18928-000

Size: D388 × H172 mm

Weight: 1.14 kg



Pastry stand cover

Material: PMMA(Acrylic)

Code: 18929-000

Size: D298 × H171.5 mm

Weight: 0.58 kg



Pastry stand (3 tiers)

Material: Stainless steel 18-10; Solid die casting

Code: 18927-000

Size: D438 × H495 mm

Weight: 3.56 kg



Fruit stand (1 tier)

Material: Stainless steel 18-10; Aluminium alloys (chrome plated)

Code: 18926-000

Size: D325 × H200 mm

Weight: 1.13 kg



Fruit stand (3 tiers)

Material: Stainless steel 18-10; Solid die casting

Code: 18925-000

Size: D375 × H530 mm

Weight: 3.10 kg



Round tea stand

Material: Stainless steel 18-10; Aluminum alloy (Chrome plated)

Code: 40017-100

Size: D210 × H227.7 mm

Weight: 0.55 kg

Code: 40017-100-RGD (rose gold)

Size: D210 × H227.7 mm

Weight: 0.55 kg



Square tea stand

Material: Stainless steel 18-10; Aluminum alloy (Chrome plated)

Code: 40017-200

Size: L210 × W210 × H227.2 mm

Weight: 0.62 kg

Code: 40017-200-RGD (rose gold)

Size: L210 × W210 × H227.2 mm

Weight: 0.62 kg





Buffet&cake stand

Material: Stainless steel 18-10; Solid die casting

Code: 19006-100

Size: D160 × H117.3 mm

Weight: 0.7 kg

Code: 19006-200

Size: D210 × H153.4 mm

Weight: 0.96 kg

Code: 19006-300

Size: D300 × H157.8 mm

Weight: 1.52 kg



Tea stand

Material: Stainless steel 18-10

Dish not included

Code: 18917-000

Size: L256 × W256 × H421 mm

Weight: 0.68 kg

Code: 18918-000

Size: L196 × W196 × H255.5 mm

Weight: 0.42 kg



Swivel high tea stand

Material: Stainless steel 18-10

Code: 19010-000

Size: L368 × W202.5 × H428 mm

Weight: 2.17 kg







Pastry rotary stand

Material: Stainless steel 18-10; Solid die casting; PC

Code: 19003-100

Size: D314 × H526 mm

Weight: 2.66 kg
(polycarbonate)



SWIVEL



High pastry rotary stand

Material: Stainless steel 18-10; Solid die casting; PC

Code: 19003-200

Size: D314 × H680 mm

Weight: 3.1 kg
(polycarbonate)



SWIVEL



Muffin and more stand

Material: Stainless steel 18-10

Code: 19004-000

Size: L411.5 × W412.5 × H446.5 mm

Weight: 3.1 kg

Related accessories 19005 and 40014-000



SWIVEL

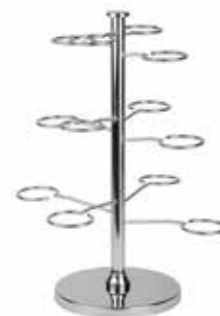







Round coaster

Material: Stainless steel 18-10

Code: 40014-000

Size: D117 × 1T

Weight: 0.07 kg

Code: 40014-000-RGD (rose gold)

Size: D117 × 1T

Weight: 0.07 kg



Display cup

Material: Glass

Code: 19005-000

Size: D65.8 × H56.6 mm

Weight: 0.05 kg

Compatible with: 19004









Square crystal block

Material: Crystal

Code: 19908-000

Size: L122 × W122 × H78 mm

Weight: 1.08 kg

Code: 19909-000

Size: L122 × W122 × H120 mm

Weight: 1.4 kg

Code: 19910-000

Size: L122 × W122 × H183 mm

Weight: 1.9 kg



Oblong platform

Material: PMMA(Acrylic)

Code: 19913-000

Size: L420 × W200 × H59 mm

Weight: 1.02 kg

Code: 19914-000

Size: L320 × W201 × H59 mm

Weight: 0.73 kg



Square platform

Material: PMMA(Acrylic)

Code: 19915-000

Size: L201 × W201 × H69 mm

Weight: 0.48 kg



Round platform

Material: PMMA(Acrylic)

Code: 19916-000

Size: D200 × H59 mm

Weight: 0.38 kg



Led battery operated light

Material: PMMA(Acrylic)

Code: 19917-000

Size: D51 × H39 mm

Weight: 0.04 kg





Treasure stand set with black marble laminate

Material: Stainless steel 18-10; Marble laminated wood (MDF); Glass

Code: 19923-000

Size: L400 x W400 x H350 mm

Weight: 11.54 kg

Glasses not included



Treasure stand set with acacia wood

Material: Stainless steel 18-10; Marble laminated wood (MDF); Glass

Code: 19931-000

Size: L400 x W400 x H350 mm

Weight: 11.54 kg

Glasses not included



Spiral stand

Material: Stainless steel 18-10

Code: 19925-185 (18.5 cm)

Package: 12 ea (36 pcs/set)

Size: D40 x H185 mm

Code: 19925-245 (24.5 cm)

Package: 12 ea (36 pcs/set)

Size: D40 x H245 mm

Code: 19925-305 (30.5 cm)

Package: 12 ea (36 pcs/set)

Size: D40 x H305 mm



Shooter glass

Material: Glass

Code: 19926-100

Package: 36 pcs/set

Size: D37 x H77 mm

Weight: 0.8 kg

Capacity: 0.03 Ltr



Solid wood base with Black

Code: 19924-000

Size: L400 x W400 x H55 mm

Weight: 6.44 kg



Solid wood base

Code: 19932-000

Size: L400 x W400 x H55 mm

Weight: 6.44 kg





PRESENTATION SETS



Twin arm food tag

Material: Stainless steel 18-10

Code: 19921 (157 mm)

Package: 10 ea

Size: L73 x W73 x H157 mm

Weight: 0.16 kg

Code: 19922 (255 mm)

Package: 10 ea

Size: L73 x W87 x H255 mm

Weight: 0.22 kg



Rolly polly food tag

Material: Solid die casting; Chrome plated; ABS w/pearl color with glitter; Stainless steel wire

Code: 19937-000

Package: 1 ea

Size: L55 x W90 x H230 mm

Weight: 0.35 kg



Mr. Tag

Material: Stainless steel 18-10

Code: 19928 (120 mm)

Package: 10 ea

Size: L35 x W48 x H120 mm

Weight: 0.04 kg

Code: 19929 (180 mm)

Package: 10 ea

Size: L54 x W63 x H180 mm

Weight: 0.10 kg



Condiment set

Material: PMMA (Acrylic); Stainless steel 18-10; Crystal; Silicone

Code: 19904-084

Size: L360 x W110 x H114 mm

Weight: 1.8 kg

Capacity: 0.17 Ltr



Condiment set ashwood stand

Material: Stainless steel 18-10; Crystal; Ashwood

Code: 19904-000-ASH

Package: 4 jars + 4 spoons + tray

Size: L400 x W120 x H97.5 mm

Weight: 1.59 kg

Items: 19905; 19906; 19907



Condiment set ashwood stand

Material: Stainless steel 18-10; Crystal; Ashwood

Code: 19904-160-ASH

Size: L400 x W120 x H173.5 mm

Weight: 2.08 kg

Capacity: 0.37 Ltr



NEW

NEW

Condiment set S.S. 18-10 (high)

Material: Stainless steel 18-10; Crystal; Silicone

Code: 19904-160

Size: L360 x W110 x H183 mm

Weight: 1.9 kg

Capacity: 0.37 Ltr



Condiment set S.S. 18-10

Material: Stainless steel 18-10; Crystal; Silicone

Code: 19904-000

Package: 4 jars + 4 spoons + tray

Size: L360 x W110 x H107 mm

Weight: 1.47 kg

Items: 19905; 19906; 19907



Condiment set items:

Jam&jelly jar server (1 ea)

Material: Stainless steel 18-10; Crystal

Code: 19905-100

Size: D80.5 x W85.5 mm

Weight: 0.18 kg

Condiment spoon (1 ea)

Material: Stainless steel 18-10

Code: 19906-000

Size: H140 mm

Weight: 0.0125 kg

Tray

Material: Stainless steel 18-10; Silicone

Code: 19907-000

Size: L360 x W110 x H67 mm

Weight: 0.72 kg

Dressing set

4 pcs of porcelain included

Material: Stainless steel 18-10; PMMA (Acrylic); Porcelain, Silicone

Code: 19935-000

Size: L755 x W150 x H79 mm

Weight: 3.5 kg





Hollowware



The Stainless steel Coffee Pot is built with double wall for heat insulation.
Lid can be open at 180° making it easier to fill up and can be cleaned in the dishwasher.
All of our Coffee Pots are made from 18/10 stainless steel.





COFFEE & TEA POTS



Tea pot (500 ml)

Material: Stainless steel 18-10

Code: 10140-000

Package: 12 ea

Size: L60 × W151.2 × H174.5 mm

Weight: 0.45 kg

Capacity: 0.5 Ltr



Tea pot (900 ml)

Material: Stainless steel 18-10

Code: 10150-000

Package: 12 ea

Size: L60 × W157.3 × H274.5 mm

Weight: 0.69 kg

Capacity: 0.9 Ltr



Coffee pot (1200 ml)

Material: Stainless steel 18-10

Code: 10160-000

Package: 12 ea

Size: L80 × W184.7 × H231 mm

Weight: 0.7 kg

Capacity: 1.2 Ltr



Coffee pot (1500 ml)

Material: Stainless steel 18-10

Code: 10170-000

Package: 12 ea

Size: L80 × W185.5 × H276 mm

Weight: 0.83 kg

Capacity: 1.5 Ltr



Sugar bowl (200 ml)

Material: Stainless steel 18-10

Code: 10180-000

Package: 12 ea

Size: L60 × W94.1 × H65 mm

Weight: 0.16 kg

Capacity: 0.2 Ltr



Milk jug (150 ml)

Material: Stainless steel 18-10

Code: 10210-000

Package: 12 ea

Size: L40 × W102.7 × H117.4 mm

Weight: 0.2 kg

Capacity: 0.15 Ltr



WATER PITCHERS



Water pitcher (1500 ml)
Material: Stainless steel 18-10
Code: 10190-000
Package: 12 ea
Size: L80 × W186 × H253 mm
Weight: 1.05 kg
Capacity: 1.5 Ltr



Water pitcher (1500 ml)
Material: Stainless steel 18-10
Code: 10190-000-RGD (rose gold)
Package: 12 ea
Size: L80 × W186 × H253 mm
Weight: 1.05 kg
Capacity: 1.5 Ltr



Water pitcher (2000 ml)
Material: Stainless steel 18-10
Code: 10200-000
Package: 12 ea
Size: L80 × W175 × H320 mm
Weight: 1.15 kg
Capacity: 2.0 Ltr



Water pitcher (2000 ml)
Material: Stainless steel 18-10
Code: 10200-000-RGD (rose gold)
Package: 12 ea
Size: L80 × W175 × H320 mm
Weight: 1.15 kg
Capacity: 2.0 Ltr



Water pitcher (single, 2000 ml)
Material: Stainless steel 18-10
Code: 10130-000
Package: 12 ea
Size: L106 × W164.8 × H250.2 mm
Weight: 0.7 kg
Capacity: 2 Ltr



Water pitcher (double, 1500 ml)
Material: Stainless steel 18-10
Code: 10230-000
Package: 12 ea
Size: L106 × W164.8 × H250.2 mm
Weight: 1.14 kg
Capacity: 1.5 Ltr



DOUBLE WALL COFFEE POTS & THERMOS

The lid can completely open till 180°.

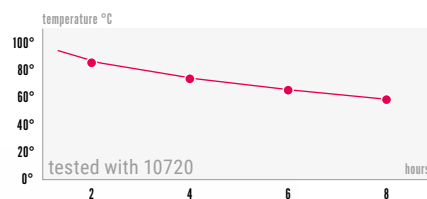
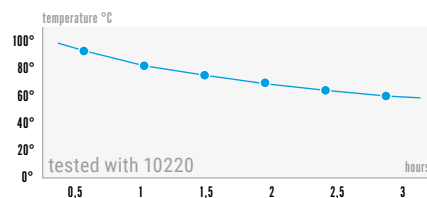

Double wall coffee pot (300 ml)

Material: Stainless steel 18-10; Solid die casting; ABS (chrome plated); Silicone

Code: 10120-RVS

Package: 12 ea
Size: L132 x W100.4 x H187 mm
Weight: 0.49 kg
Capacity: 0.3 Ltr



Double wall coffee pot (600 ml)

Material: Stainless steel 18-10; Solid die casting; ABS (chrome plated); Silicone

Code: 10220-RVS

Package: 12 ea
Size: L132 x W100.4 x H212 mm
Weight: 0.57 kg
Capacity: 0.6 Ltr



Double wall coffee pot (950 ml)

Material: Stainless steel 18-10; Solid die casting; ABS (chrome plated); Silicone

Code: 10320-RVS

Package: 12 ea
Size: L132 x W100.4 x H239 mm
Weight: 0.64 kg
Capacity: 0.95 Ltr



Double wall coffee pot (1200 ml)

Material: Stainless steel 18-10; Solid die casting; ABS (chrome plated); Silicone

Code: 10420-RVS

Package: 12 ea
Size: L155.6 x W116.5 x H255.4 mm
Weight: 0.82 kg
Capacity: 1.2 Ltr



Double wall coffee pot (1500 ml)

Material: Stainless steel 18-10; Solid die casting; ABS (chrome plated); Silicone

Code: 10520-RVS

Package: 12 ea
Size: L155.6 x W116.5 x H268.7 mm
Weight: 0.89 kg
Capacity: 1.5 Ltr



Vacuum thermo (400 ml)

Material: Stainless steel 18-10; Solid die casting handle

Code: 10620-000

Package: 12 ea
Size: L185 x W112 x H180 mm
Weight: 0.72 kg
Capacity: 0.4 Ltr



Vacuum thermo (700 ml)

Material: Stainless steel 18-10; Solid die casting handle

Code: 10720-000

Package: 12 ea
Size: L188 x W112 x H200 mm
Weight: 0.82 kg
Capacity: 0.7 Ltr



Vacuum thermo (1000 ml)

Material: Stainless steel 18-10; Solid die casting handle

Code: 10820-000

Package: 12 ea
Size: L195 x W130 x H205 mm
Weight: 0.9 kg
Capacity: 1 Ltr



Vacuum thermo (1500 ml)

Material: Stainless steel 18-10; Solid die casting handle

Code: 10920-000

Package: 12 ea
Size: L200 x W130 x H235 mm
Weight: 1.2 kg
Capacity: 1.5 Ltr



WINE COOLERS



Smiley ice bucket

Material: Stainless steel 18-10; PMMA (Acrylic)

Code: 40003-000

With ice tong

Size: D145 × H258.5 mm

Weight: 0.82 kg

Capacity: 1.7 Ltr



Smiley ice bucket

Material: Stainless steel 18-10; PMMA (Acrylic)

Code: 40003-000-RGD (rose gold)

With ice tong

Size: D145 × H258.5 mm

Weight: 0.82 kg

Capacity: 1.7 Ltr



Smiley wine bucket

Material: Stainless steel 18-10

Code: 40004-000

Size: D180 × H210 mm

Weight: 1.07 kg

Capacity: 5 Ltr





Smiley wine bucket

Material: Stainless steel 18-10

Code: 40004-000-RGD (rose gold)

Size: D180 × H210 mm

Weight: 1.07 kg

Capacity: 5 Ltr



Ice tong with bottle opener

Material: Stainless steel 18-10

Code: 40007-000

Size: L15 × W33.4 × H167.5 mm

Weight: 0.05 kg



Smiley wine bucket stand

Material: Stainless steel 18-10; Aluminium alloys (chrome plated)

Code: 40012-000

Size: D270 × H606 mm

Weight: 3.37 kg

Compatible with: 40004-000





Ice bucket with double wall

Material: Stainless steel 18-10

Code: 11600-000

Size: D170 × H198 mm

Weight: 0.7 kg

Capacity: 0.94 Ltr



Double wall ice bucket with acrylic lid

Material: Stainless steel 18-10; PMMA (Acrylic)

Code: 11600-200

Size: D165 × H150 mm

Weight: 0.7 kg

Capacity: 1.2 Ltr



Thimble ice bucket with ice tong
Material: Stainless steel 18-10; PMMA (Acrylic)
Code: 40005-000
Size: D197 × H265.5 mm
Weight: 1.19 kg
Capacity: 1.7 Ltr



Inset for ice
Material: PMMA (Acrylic)
Code: 40005-100
Size: D144.5 × 120 mm
Weight: 0.23 kg



Thimble wine cooler
Material: Stainless steel 18-10
Code: 40006-000
Size: D250 × H200 mm
Weight: 1.65 kg
Capacity: 4.7 Ltr



Thimble wine bucket stand
Material: Stainless steel 18-10; Aluminium alloys (chrome plated); PMMA (Acrylic)
Code: 40013-000
Size: D270 × H609 mm
Weight: 3.32 kg
Compatible with: 40006-000



Thimble w/ table wire hook
Material: Stainless steel 18-10; Silicone
Code: 40008-000
Size: L198 × W380.6 × H109.8 mm
Weight: 0.65 kg
Compatible with: 40006-000





Thimble punch bowl (20 Ltr)

Material: Stainless steel 18-10

Code: 40009-000

Size: D455 × H250 mm

Weight: 4.08 kg

Capacity: 20 Ltr



Punch bowl

Material: Stainless steel 18-10

Code: 11610-000

Size: D446 × H276 mm

Weight: 2.2 kg

Capacity: 20 Ltr

Code: 11611-000

Size: D375 × H247.5 mm

Weight: 1.64 kg

Capacity: 14 Ltr





Manhattan wine ice bucket

Material: Stainless steel 18-10 (PVD coated & glass bead sanding), PMMA (Acrylic)

Code: 40010-000

Size: L140 × W180 × H275.5 mm

Weight: 1.61 kg

Capacity: 2.6 Ltr



Manhattan wine grotto

Material: Stainless steel 18-10 (PVD coated & glass bead sanding)

Code: 40011-000

Size: L150 × W340 × H200 mm

Weight: 3.14 kg

Capacity: 8.6 Ltr



OTHERS



Smiley single flower vase

Material: Stainless steel 18-10; PMMA (Acrylic)

Code: 40001-100
Size: D38 x H143 mm
Weight: 0.16 kg

Code: 40001-200
Size: D38 x H193 mm
Weight: 0.2 kg



Smiley single candle holder

Material: Stainless steel 18-10; PMMA (Acrylic)

Code: 40001-300
Size: D38 x H143 mm
Weight: 0.16 kg



Smiley single flower vase

Material: Stainless steel 18-10

Code: 40002-100
Size: D89.1 x H243 mm
Weight: 0.5 kg

Code: 40002-200
Size: D89.1 x H293 mm
Weight: 0.62 kg







S.S. bread basket

Material: Stainless steel 18-10

Code: 40018-100

Size: L220 x W220 x H39 mm

Weight: 0.33 kg

Code: 40018-100-RGD (rose gold)

Size: L220 x W220 x H39 mm

Weight: 0.33 kg

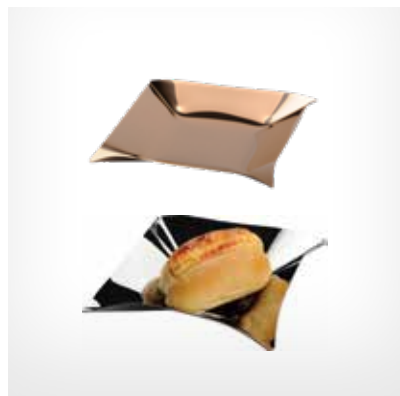

S.S. bread basket

Material: Stainless steel 18-10

Code: 40018-200

Size: L284 x W186 x H44 mm

Weight: 0.53 kg

Code: 40018-200-RGD (rose gold)

Size: L284 x W186 x H44 mm

Weight: 0.53 kg



S.S. bread basket

Material: Stainless steel 18-10

Code: 40018-300

Size: L285 x W140 x H39 mm

Weight: 0.45 kg

Code: 40018-300-RGD (rose gold)

Size: L285 x W140 x H39 mm

Weight: 0.45 kg



S.S. bread basket

Material: Stainless steel 18-10

Code: 40018-400

Size: L240 x W240 x H39 mm

Weight: 0.51 kg

Code: 40018-400-RGD (rose gold)

Size: L240 x W240 x H39 mm

Weight: 0.51 kg



Manhattan square tray

Material: Stainless steel 18-10

Code: 19007-100

Size: L340 x W340 x H30 mm

Weight: 1.4 kg

Code: 19007-100-RGD (rose gold)

Size: L340 x W340 x H30 mm

Weight: 1.4 kg



Manhattan square tray

Material: Stainless steel 18-10

Code: 19007-200

Size: L450 x W450 x H30 mm

Weight: 2.3 kg



Manhattan oblong tray
 Material: Stainless steel 18-10
Code: 19007-300
 Size: L365 x W185 x H20 mm
 Weight: 0.8 kg



Manhattan jam holder
 Material: Stainless steel 18-10
Code: 19007-400
 Size: L180 x W50 x H20 mm
 Weight: 0.14 kg



Manhattan tea holder
 Material: Stainless steel 18-10
Code: 19007-500
 Size: L115 x W65 x H40 mm
 Weight: 0.17 kg

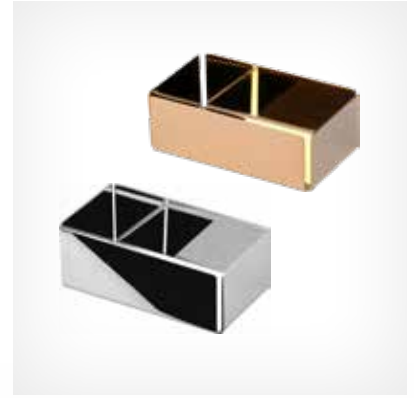

Code: 19007-400-RGD (rose gold)
 Size: L180 x W50 x H20 mm
 Weight: 0.14 kg

Code: 19007-500-RGD (rose gold)
 Size: L115 x W65 x H40 mm
 Weight: 0.17 kg

Manhattan sugar bag holder
 Material: Stainless steel 18-10
Code: 19007-600
 Size: L65 x W65 x H40 mm
 Weight: 0.14 kg



Oil & vinegar set
 Material: Stainless steel 18-10; Borosilicate glass
Code: 40020-000
 Size: L170 x W80 x H282 mm
 Weight: 1.1 kg
 Capacity: Oil&Venegar Glass 0.2 Ltr
 Salt&Pepper Glass 0.04 Ltr



Caviar cup
 Material: Stainless steel 18-10; Borosilicate glass
Code: 40024-000
 Size: D168 x H76.5 mm
 Weight: 0.6kg
 Capacity: 0.12 Ltr



Jam Stand
 Material: Stainless steel 18-10
Code: 40026-000
 Size: L116.4 x W126 x H200 mm
 Weight: 0.2 kg



















Flatware



AMALFI 7 mm





	DESCRIPTION	ITEM NO.	SIZE mm	THICKNESS mm	WEIGHT g
	DINNER KNIFE	CT-AM001-000	240	8	104
	DINNER FORK	CT-AM002-000	210	7	50
	DINNER SPOON	CT-AM003-000	210	3	64
	DESSERT KNIFE	CT-AM004-000	211	7.0	75.0
	DESSERT FORK	CT-AM005-000	185	2.5	32.0
	DESSERT SPOON	CT-AM006-000	185	2.8	40.0
	MOCCA(COFFEE) SPOON	CT-AM007-000	116	1.5	12.0
	TEA SPOON	CT-AM008-000	140	2.0	18.0
	BUTTER KNIFE	CT-AM009-000	168	2.0	22.0
	CAKE FORK	CT-AM010-000	185	2.5	34.0
	FISH KNIFE	CT-AM011-000	205	2.5	40.0
	FISH FORK	CT-AM012-000	185	2.5	34.0
	SOUP SPOON	CT-AM013-000	177	2.5	38.0
	ICE TEA SPOON	CT-AM014-000	180	2.2	25.0

BOLSENA 5.5 mm





	DESCRIPTION	ITEM NO.	SIZE mm	THICKNESS mm	WEIGHT g
	DINNER KNIFE	CT-BS001	240	7.4	92.0
	DINNER FORK	CT-BS002	215	4.9	60.0
	DINNER SPOON	CT-BS003	210	4.7	68.0
	DESSERT KNIFE	CT-BS004	220	7.4	70.0
	DESSERT FORK	CT-BS005	185	4.2	42.0
	DESSERT SPOON	CT-BS006	180	4.2	46.0
	SOUP SPOON	CT-BS007	180	4.0	52.0
	CAKE FORK	CT-BS008	149	4.0	18.0
	TEA SPOON	CT-BS009	140	3.6	22.0
	MOCCA(COFFEE) SPOON	CT-BS010	113	2.8	16.0
	FISH KNIFE	CT-BS011	235	9.0	90.0
	FISH FORK	CT-BS012	215	5.5	56.0
	BUTTER KNIFE	CT-BS013	167	4.0	32.0

CORTINA 5 mm





	DESCRIPTION	ITEM NO.	SIZE mm	THICKNESS mm	WEIGHT g
	DINNER KNIFE	CT-C0001-000	235	9.0	85.0
	DINNER FORK	CT-C0002-000	204	5.0	52.0
	DINNER SPOON	CT-C0003-000	203	5.0	70.0
	DESSERT KNIFE	CT-C0004-000	213	8.0	64.0
	DESSERT FORK	CT-C0005-000	185	4.4	44.0
	DESSERT SPOON	CT-C0006-000	185	4.4	52.0
	STEAK KNIFE	CT-C0007-000	235	9.0	84.0
	MOCCA(COFFEE) SPOON	CT-C0008-000	118	2.8	14.0
	TEA SPOON	CT-C0009-000	137	4.0	30.0
	BUTTER KNIFE	CT-C0010-000	161	6.5	42.0
	CAKE FORK	CT-C0011-000	144	3.5	22.0
	FISH KNIFE	CT-C0012-000	221	5.0	65.0
	FISH FORK	CT-C0013-000	203	5.0	58.0
	SOUP SPOON	CT-C0014-000	178	4.5	60.0
	ICE TEA SPOON	CT-C0015-000	201	3.7	30.0
	SERVING FORK	CT-C0016-000	231	4.5	71.0
	SERVING SPOON	CT-C0017-000	233	4.5	95.0

GARDA 3 mm





	DESCRIPTION	ITEM NO.	SIZE mm	THICKNESS mm	WEIGHT g
	DINNER KNIFE	CT-GA001	240.0	7.1	98.0
	DINNER FORK	CT-GA002	205.0	2.8	52.0
	DINNER SPOON	CT-GA003	200.0	3.0	60.0
	DESSERT KNIFE	CT-GA004	220	5.7	67.0
	DESSERT FORK	CT-GA005	175	2.6	34.0
	DESSERT SPOON	CT-GA006	172	2.7	40.0
	MOCCA(COFFEE) SPOON	CT-GA007	110	1.9	12.0
	TEA SPOON	CT-GA008	142	2.1	21.0
	FISH KNIFE	CT-GA009	220	2.9	60.0
	FISH FORK	CT-GA010	189.5	2.5	34.0
	SOUP SPOON	CT-GA011	180	2.8	46.0
	CAKE FORK	CT-GA012	155	2.0	20.0
	BUTTER KNIFE	CT-GA013	162	2.2	30.0

ISEO 5 mm



















	DESCRIPTION	ITEM NO.	SIZE mm	THICKNESS mm	WEIGHT g
	DINNER KNIFE	CT-IS001-000	235	8.0	90.0
	DINNER FORK	CT-IS002-000	210.0	4.9	68.0
	DINNER SPOON	CT-IS003-000	210.0	4.3	76.0
	DESSERT KNIFE	CT-IS004-000	205.0	5.0	64.0
	DESSERT FORK	CT-IS005-000	190	4.7	50.0
	DESSERT SPOON	CT-IS006-000	189	4.5	62.0
	MOCCA(COFFEE) SPOON	CT-IS007-000	120	3.5	20.0
	TEA SPOON	CT-IS008-000	138	3.9	28.0
	FRUIT FORK	CT-IS009-000	143	3.8	22.0
	CAKE FORK	CT-IS010-000	155	4.7	35.0
	FISH KNIFE	CT-IS011-000	199	4.5	50.0
	FISH FORK	CT-IS012-000	182	4.5	42.0
	SOUP SPOON	CT-IS013-000	193	4.5	74.0
	SERVING FORK	CT-IS014-000	230	5.0	95.0
	SERVING SPOON	CT-IS015-000	226	5.3	105.0
	BUTTER KNIFE	CT-IS016-000	172	3.5	39.0

MAGGIORE 6 mm





	DESCRIPTION	ITEM NO.	SIZE mm	THICKNESS mm	WEIGHT g
	DINNER KNIFE	CT-MG001	240	8.5	110
	DINNER FORK	CT-MG002	202	6	70
	DINNER SPOON	CT-MG003	202	6	79
	DESSERT KNIFE	CT-MG004	217	8.5	80.0
	DESSERT FORK	CT-MG005	180	5.0	51.0
	DESSERT SPOON	CT-MG006	180	5.0	63.0
	STEAK KNIFE	CT-MG007	235	9.0	111.0
	MOCCA(COFFEE) SPOON	CT-MG008	110	4.0	16.0
	TEA SPOON	CT-MG009	145	4.0	33.0
	BUTTER KNIFE	CT-MG010	177	4.0	39.0
	CAKE FORK	CT-MG011	147	4.0	27.0
	FISH KNIFE	CT-MG012	205	6.0	75.0
	FISH FORK	CT-MG013	200	6.0	71.0
	SOUP SPOON	CT-MG014	190	6.0	86.0
	ICE TEA SPOON	CT-MG015	213	4.0	42.0
	SERVING FORK	CT-MG016	240	6.0	110.0
	SERVING SPOON	CT-MG017	242	6.0	120.0



TIGER HOTEL
www.tigerhotel.com

Trolleys



SERVICE TROLLEYS



Modern service trolley

Material: Stainless steel 18-10; Steel (powder coated); Wood (MDF)

Code: 20791-000

Size: L101 x W51 x H85 cm



Modern service trolley (oak)

Material: Stainless steel 18-10; Steel (powder coated); Wood (MDF)

Code: 20791-OAK

Size: L101 x W51 x H85 cm



Modern trolley-carving station

Material: Stainless steel 18-10; Steel (powder coated); Wood (MDF); Artificial marble; Phenol

Code: 20792-000

Rating: 110V 1,500W / 230V 1,500W~1,750W
(carving board heater 110V/230V 1,000 W;
heating lamp 110V 250V x2EA/230V 250~375 W x 2EA)
Size: L120.5 x W61 x H147.6 cm



Modern trolley-carving station with sneeze guard

Material: Stainless steel 18-10; Steel (powder coated); Wood (MDF); Artificial marble; Tempered glass; (transparent); Phenol

Code: 20792-100

Rating: 110V 1,500W / 230V 1,500W~1,750W (carving board heater 110V/230V 1,000 W; heating lamp 110V 250V x2EA/230V 250~375 W x 2EA)
Size: L120.5 x W61 x H148 cm



Modern trolley - hot station

Material: Corian; Stainless steel 18-10; Steel (powder coated); Wood (MDF); Artificial marble

Code: 20793-000

Rating: 110V / 230V 1,000W
Size: L120.5 x W61 x H85 cm



Modern trolley - hot station with sneeze guard

Material: Corian; Tempered glass; Stainless steel 18-10; Steel (powder coated); Wood (MDF); Artificial marble

Code: 20793-100

Rating: 110V / 230V 1,000W
Size: L120.5 x W61 x H139.4 cm



Modern trolley - cold/salad station

Material: Stainless steel 18-10; Steel (powder coated); Wood (MDF); Artificial marble

Code: 20794-000

Size: L120.5 x W61 x H85 cm



Modern trolley - salad bar with sneeze guard

Material: Stainless steel 18-10; Steel (powder coated); Wood (MDF); Artificial marble; Tempered glass (transparent)

Code: 20794-100

Size: L120.5 x W61 x H139.4 cm



Modern trolley - front cooking station (induction type)

Material: Corian; Stainless steel 18-10; Steel (powder coated); Wood (MDF)

Code: 20796-000

Rating: 220V-240V, 1,800W induction cooker
Size: L120.5 x W61 x H85 cm





Modern trolley - front cooking station (induction type) with sneeze guard

Omelet topping compartments not included
 Material: Corian; Tempered Glass, Stainless steel 18-10;
 Steel (powder coated); Wood (MDF)

Code: 20796-100

Rating: 220V-240V, 1,800W induction cooker
 Size: L120.5 × W61 × H139.4 cm



Sneeze guard

Material: Stainless steel 18-10; Tempered glass (transparent)

Code: 20797-000

Size: L117.8 × W57.6 × H54.4 cm
 Compatible with: 20793; 20794



Sneeze guard

Material: Stainless steel 18-10; Tempered glass (transparent)

Code: 20798-000

Size: L110 × W23.7 × H63.9 cm
 Compatible with: 20796; 20792



6 Omelet topping compartments optional

Material: PMMA (Acrylic); PC

Code: 20799-000

Size: L995 × W189 × H130 mm
 Compatible with: 20796

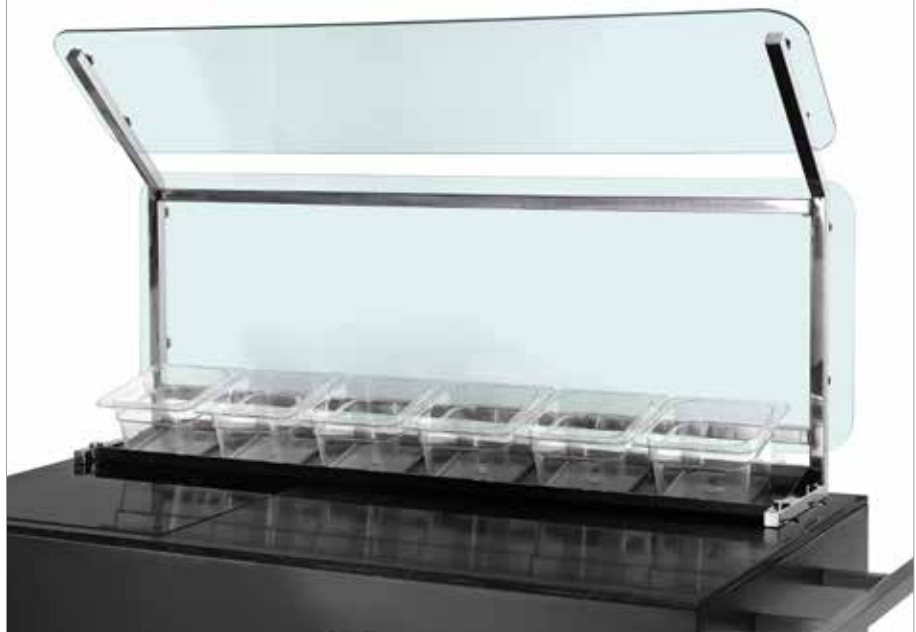



Roast beef trolley

Material: Stainless steel 18-10; Natural wood; Plywood; Brass; POM

Code: 20110-000

Size: L114 x W60 x H107.5 cm
Weight: 100 kg



Roast beef trolley

Material: Stainless steel 18-10; Natural wood; Plywood; Brass; POM

Code: 20120-000

Size: L114 x W60 x H107.5 cm
Weight: 100 kg



Roast beef trolley

Material: Stainless steel 18-10; Natural wood; Plywood; Brass; POM

Code: 20140-000

Size: L114 x W60 x H107.5 cm
Weight: 100 kg



Palace service trolley 1

Material: Stainless steel 18-10; Natural wood; Plywood; Zinc

Code: 20751-000

Size: L88 x W50 x H84 cm
Weight: 35 kg



Palace service trolley 2

Material: Stainless steel 18-10; Natural wood; Plywood; Zinc

Code: 20752-000

Size: L88 x W50 x H84 cm
Weight: 40 kg



Palace service trolley 3

Material: Stainless steel 18-10; Natural wood; Plywood; Zinc

Code: 20753-000

Size: L88 x W50 x H84 cm
Weight: 40 kg



Palace service trolley 4

Material: Stainless steel 18-10; Natural wood; Plywood; Zinc

Code: 20754-000

Size: L88 x W50 x H84 cm
Weight: 60 kg



Palace service trolley 5

Material: Stainless steel 18-10; Natural wood; Plywood; Zinc

Code: 20755-000

Size: L88 x W50 x H84 cm
Weight: 60 kg



Flambé trolley

Material: Stainless steel 18-10; Natural wood; Plywood; Zinc

Code: 20271-000

Size: L134.5 x W50 x H81 cm
Weight: 85 kg



Banquet bar trolley

Material: Stainless steel 18-10; Wood (MDF); Marble

Code: 20424-000

Size: L180 x W70 x H110 cm



Royal flambé trolley

Material: Stainless steel 18-10; Natural wood; Plywood; Zinc

Code: 20275-000

Size: L140 x W58 x H85 cm

Weight: 85 kg



Dessert trolley

Material: Stainless steel 18-10; Natural wood; Plywood; Brass

Code: 20701-000

Size: L93 x W56 x H85 cm

Weight: 40 kg



ROOM SERVICE TROLLEYS & HOT FOOD WARMERS



Royal room service trolley
 Material: Stainless steel 18-10; Melamine coated plywood;
 Powder coated steel
Code: 20783-RVS
 Size: L106.7 x W91.5 x H75.5 cm
 Weight: 28.8 kg

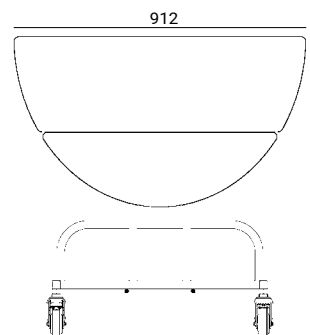
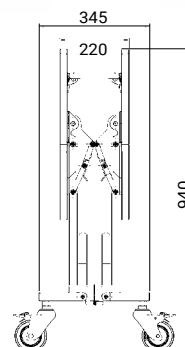
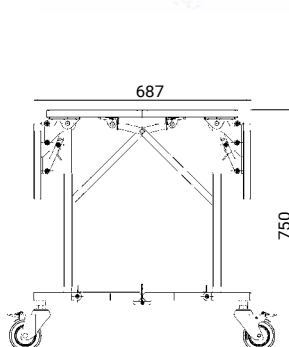



Palace room service trolley

Material: Melamine coated plywood; Powder coated steel

Code: 20782

Size: D102 × H75 cm

Weight: 26.7 kg

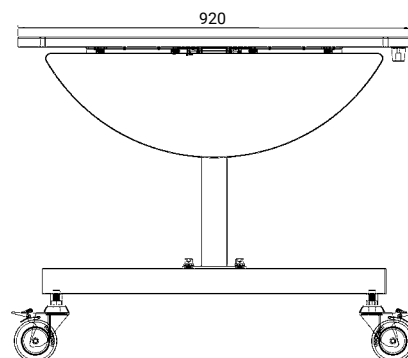
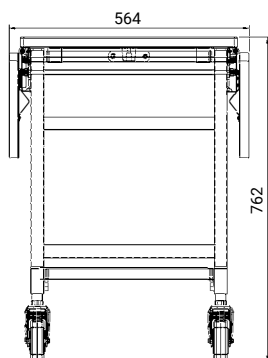

FEATURES:

1. Convenient temperature display window
2. Improved on the heat retention (keep the temp. up to 40°)
3. Convenient AC socket position on a side of warmer for easy management the power cord
4. Modern and elegantly rounded design with black PVD coated stainless steel
5. Anti-scratch door latch
6. Ergonomic built-in side handles
7. Accurate temperature control thanks to PCB



New generation hot food warmer (230 V)

Material: Stainless steel 18-10 (PVD coated); Aluminium

Code: 11812-230

Rating: 230V, 365W

Size: L388 × W393 × H487.5

Weight: 10.4 kg



Hot food warmer

Material: Stainless steel 18-10

Code: 11811-304-230V, 11811-304-110V

Rating: 230V, 365W

Size: L390 × W370 × H495 mm



Hot food warmer caddy

Material: Stainless steel 18-10; Powder coated steel pipe (black)

Code: 11811-CAD

Size: L167.5 × W52.8 × H186.2 cm





DISH RACK CARTS & STACKING TROLLEYS



Dish rack cart - 1 tier (knock-down package)

Material: Powder coated steel pipe (black); PVC

Code: 22171-000

Size: L58 x W58 x H100 cm

Weight: 19 kg



Dish rack cart cover - 1 tier

Dish rack cart not included

Material: PU

Code: 22171-100



Dish rack cart - 2 tiers (knock-down package)

Material: Powder coated steel pipe (black); PVC

Code: 22172-000

Size: L58 x W58 x H175 cm

Weight: 29.8 kg

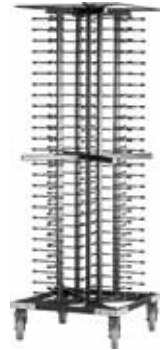

Dish rack cart cover - 2 tiers

Dish rack cart not included

Material: PU

Code: 22172-100



Ibis stacking trolley

Material: Powder coated steel pipe; Rubber carpet

Code: 91101-000

Size: L980 x W695 x H1546 mm

Weight: 30 kg



Ibis stacking trolley pvc cover

Material: PVC

Code: 91101-PVC

Size: L980 x W710 x H1400 mm (folded: H100 mm)



LUGGAGE CARTS, HOUSE KEEPING & CANVAS TROLLEYS



Hanger luggage cart with brass

Material: Titanium plated stainless steel 18-10; PVC; Carpet

Code: 24212-000

Size: L118.5 x W63 x H180 cm

Weight: 36 kg



Luggage cart with brass

Material: Titanium plated stainless steel 18-10; PVC; Carpet

Code: 24213-000

Size: L118.5 x W63 x H100 cm

Weight: 33 kg



Luggage cart with S.S.

Material: Stainless steel 18-10; PVC; Carpet

Code: 24203-000

Size: L110 x W63 x H100 cm

Weight: 33 kg



Crown luggage cart

Material: Titanium plated stainless steel 18-10; PVC; Carpet

Code: 24214-000

Size: L120 × W63 × H182 cm

Weight: 42 kg



Hanger luggage cart

Material: Titanium plated stainless steel 18-10; PVC; Carpet

Code: 24215-000

Size: L120 × W63 × H180 cm

Weight: 34 kg



Bell man hand cart with S.S.

Material: Stainless steel 18-10; Carpet

Code: 24113-000

Size: L85 × W55 × H120 cm

Weight: 18 kg



Room maid trolley with roll-front

Material: Powder coated steel; PVC; Uretane coated wood; Canvas; PMMA(Acrylic)

Code: 23211-000

Size: L120 × W54 × H135 cm

Weight: 43 kg



Room maid trolley without roll-front

Material: Powder coated steel; PVC; Uretane coated wood; Canvas; PMMA(Acrylic)

Code: 23211-100

Size: L120 × W54 × H135 cm

Weight: 45 kg



Room maid trolley

Material: Stainless steel 18-10; Wood (MDF); Canvas; PVC

Code: 23101-000

Size: L130 × W45 × H105 cm

Weight: 38 kg



Room maid trolley

Material: Stainless steel 18-10; Wood (MDF); Canvas; PVC

Code: 23103-000

Size: L105 × W45 × H105 cm

Weight: 35 kg



Canvas basket truck

Material: Stainless steel 18-10; Canvas

Code: 23302-000

Size: L75 × W55 × H75 cm

Weight: 8 kg



Mini bar restocking cart

Material: Stainless steel 18-10; Powder coated steel plate; PVC

Code: 23131-000

Size: L93 × W56 × H120 cm

Weight: 45 kg



