

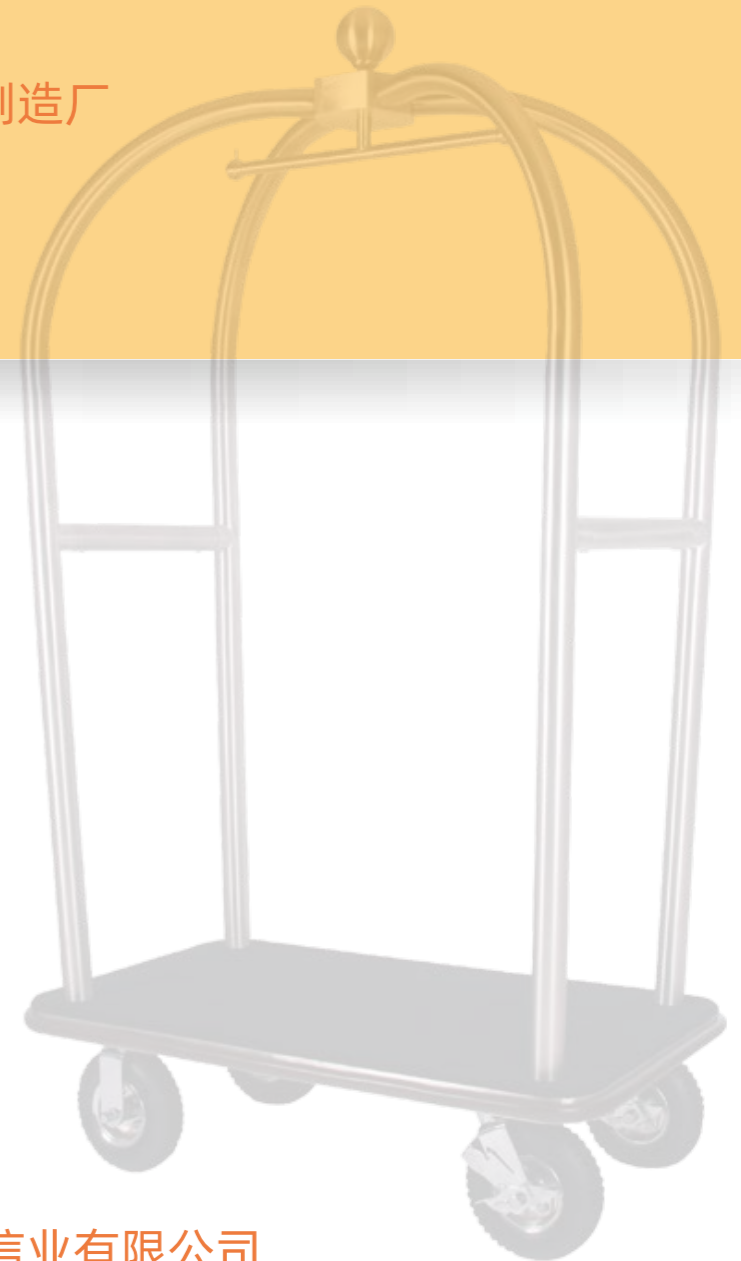

HOTEL SUPPLIES

源自1996·专业酒店用品制造厂

高品质/斯迪造  
HOTEL SUPPLIES



广州中展信业有限公司

GUANGZHOU SINO TREND INDUSTRIES CO.,LTD

+8620-86097811 +86-18122387279 Fax:+8620-86097892

广东省广州市白云区嘉禾街长红村第二工业区  
No.33 ,Hepu RD,Changhong Village,Second Industrial,  
JiaheStreet,Baiyun District Guangzhou,China.

E-mail:sitty99@sitty.com.cn  
Website:www.sitty.com.cn



2020

广州中展信业有限公司  
2020

# SITTY

专业酒店推车制造商  高品质/斯迪造



## 公司简介

广州中展信业有限公司是全球领先的酒店及商业环境用品制造商。成立于一九九六年，是一家集设计、生产、销售、服务为一体的企业。拥有行业专业技工及先进设备的厂房，服务全球酒店，提升酒店用户的客户体验。

历经二十四年酒店用品行业的磨练与洗礼，现今中展信业已凭借优质的产品、一流的服务成为酒店行业的知名企业。中展信业旗下已拥有“斯迪”：已成为国内酒店用品知名品牌，产品多达百种，灵活运用多元化的材质致力于酒店及商业公共环境用品的设计、生产、销售。产品涵盖酒店大堂、客房、洗衣房、餐饮、户外、公共区域等各种场所。

广州中展信业有限公司以“创新，为顾客创造更高价值”为己任。全心打造自主品牌，让全球客户享有优质的产品与一流的服务，实现双赢。



Guangzhou Sino Trend Industries Co.Ltd is the leader of manufacturer of hotel & commercial product supplies in domestic. Established in 1996, which is a enterprise with services of product design, manufacture and sale. We have professional technicians and advanced equipment and high quality service makes our products are sold to hotel all over the world and promotes the hotel customer experience of using.

Twenty-four years' experience, relying on our own solid power of productivity and best service, our company has been developed into a professional enterprise.

Today, Sino Trend created brand "SITTY" which has become a domestic hotel supplies well-known brand. Thousand kinds of products. Flexibility in the use of diversified material apply to hotel supplies in the design, sales. Leading products have: Lobby hall equipment, Guestroom equipment, Laundry room, food & beverage equipment, Outdoor and public area, etc.

We are endeavor to develop our own brand, in order to create higher value and cooperate with customers whom enjoy the high-quality products and first-class service. Hope we can achieve mutual benefit and reciprocity.





客房布草车系列  
Guest Room Service Cart | 007-024



大堂书报架 雨伞架系列  
Lobby Newspaper Shelf  
Umbrella stand | 064-066



客房加床系列  
Guest Room Rollaway Bed | 025-027



大堂配套产品  
Lobby Relevant Products | 067-068



客房垃圾桶 冰桶 托盘系列  
Guest Room Dustbin  
Ice bucket/Tray | 028-032



餐饮送餐车 酒水车系列  
Food and beverage Room service trolley  
Wine and liquor cart  
Service cart | 071-081



客房衣帽架 行李架系列  
Guest Room Coats Hanger  
Luggage Rack | 033-035



餐饮服务车 餐边柜系列  
Service cart | 082-086



大堂行李车系列  
Lobby Luggage Cart | 040-047



餐饮煮热车 牛肉车系列  
Food and beverage Cooking Cart  
Buffet cart | 087-090



大堂栏杆座系列  
Lobby Handrail Base | 048-052



餐饮宴会演讲台系列  
Food and beverage Podium | 092-095



大堂分类垃圾桶 烟灰桶系列  
Classified Dustbin  
Lobby Ash Bin | 053-060



餐饮自助餐车 宴会设施系列  
Food and beverage Buffet series  
Banquest service | 096-106



大堂指示牌系列  
Lobby Indication Sign | 061-064



户外垃圾桶系列  
Outdoor Dustbin | 108-110



# GUEST ROOM EQUIPMENT

客房用品系列-

房口车/布草车/加床/客房桶/衣帽架/行李椅

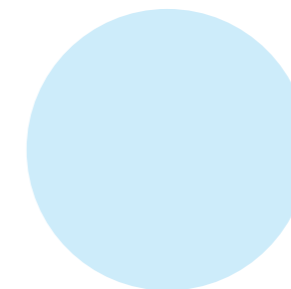
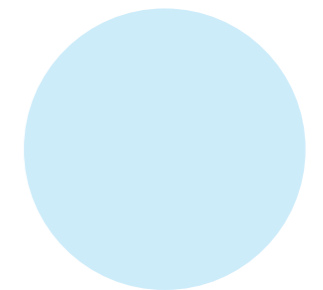
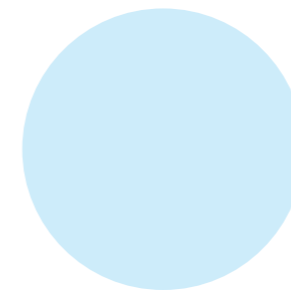
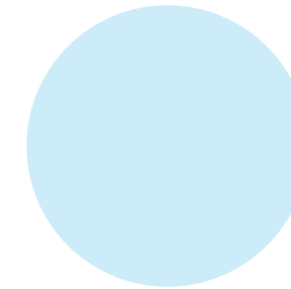
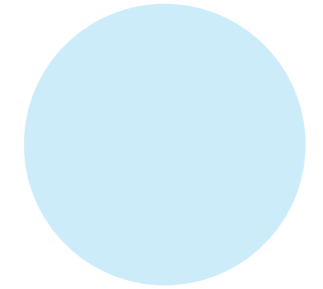
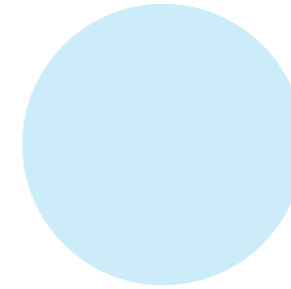
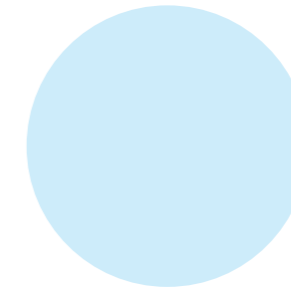



9808系列-独家创新组合式客房服务车  
随拆随组，使用毫不费力，适应各种  
使用环境，可按需选购组合类型。



可拆单用车身



Dimension:1560\*525\*1190Hmm.  
Model.NO.99.9808H1  
铁制房口车



Dimension:1720\*500\*1300Hmm.  
Model.NO.99.9808TM



可拆分单边布草车



Dimension:2080\*525\*1190Hmm.  
Model.NO.99.9808H  
铁制房口车



上下连接卡扣更稳固



Dimension:1560\*525\*1220Hmm.  
Model.NO.99.9808H1S  
电动车



可选布袋



可拆单用车身



可拆分单边布草车



上下连接卡扣更稳固

新品房口车



Dimension:918\*540\*1080Hmm.  
铝制房口车车身

9808系列-独家创新组合式客房服务车  
随拆随组，使用毫不费力，适应各种  
使用环境，可按需选购组合类型。



Dimension:1390\*540\*1180Hmm.  
Model.NO.98.9808  
铝制房口车



Dimension:1090\*535\*1100Hmm.  
Model.NO.99.7811  
简易房口车



Dimension:1040\*520\*1100Hmm.  
Model.NO.99.9808Q  
酒水运输车

www.sitty.com.cn 高品质 斯迪造 HIGH QUALITY MADE BY SITTY



Dimension:479\*450\*1075Hmm.  
铝制房口车单边布草车



Dimension:1855\*540\*1180Hmm.  
Model.NO.98.9808H  
铝制房口车



Dimension:1540\*560\*1200Hmm.  
Model.NO.99.9809  
圆弧房口车



Dimension:1560\*520\*1150Hmm.  
Model.NO.99.9809D  
圆弧房口车



连接扣



Dimension:1620\*540\*1180Hmm.  
Model.NO.98.9808TM  
铝制房口车



9803系列经典客房服务车

可选布袋



Dimension:380\*260\*730Hmm.

侧拉链样式



Dimension:380\*260\*730Hmm.

Dimension:380\*260\*540Hmm.



Dimension:1450\*500\*1200Hmm.  
Model.NO.99.9803TGO+95.9891SGO  
9803铁制房口车



Dimension:1450\*500\*1200Hmm.  
Model.NO.99.9803TF+95.9891S-1  
9803铁制房口车



Dimension:1450\*500\*1200Hmm.  
Model.NO.99.9803TFBG+95.9891SBG  
9803铁制房口车

可选分隔栏



Dimension:716\*406\*406Hmm.



Dimension:716\*406\*200Hmm.



Dimension:716\*406\*100Hmm.



Dimension:1450\*500\*1406Hmm.  
Model.NO.99.9803TFGO+95.9893GO  
9803铁制房口车



Dimension:1440\*500\*1300Hmm.  
Model.NO.99.9814DA  
9814DA铁制房口车

MAID  
CAR



Dimension:1450\*500\*1200Hmm.  
Model.NO.99.9803T+95.9891SBB  
9803铁制房口车



Dimension:1450\*500\*1200Hmm.  
Model.NO.99.9803T+99.9895B  
9803铁制房口车



Dimension:1460\*520\*1140Hmm.  
Model.NO.99.7801C  
7801C铁制房口车



Dimension:1460\*520\*1140/784\*448\*165Hmm.  
Model.NO.99.7801+99.7891  
7801铁制房口车



Dimension:1450\*500\*1200Hmm.  
Model.NO.92.9803T  
9803铁制房口车



Dimension:1450\*500\*1200Hmm.  
Model.NO.99.9803TH  
9803铁制房口车



Dimension:1460\*520\*1190Hmm.  
Model.NO.99.7801DH  
7801DH房口车



Dimension:1440\*520\*1190Hmm.  
Model.NO.99.7803DH  
7803DH房口车





Dimension:1440\*500\*1140Hmm.  
Model.NO.90.9803DGT  
9803DGT房口车



Dimension:1446\*500\*1190Hmm.  
Model.NO.99.9803TD3  
9803TD3房口车



Dimension:1600\*550\*1180Hmm.  
Model.NO.99.7816  
7816房口车



Dimension:1420\*530\*1360Hmm.  
Model.NO.99.7815  
7815房口车



Dimension:1457\*500\*1190Hmm.  
Model.NO.99.7801T  
7801T铁制房口车



Dimension:1060\*575\*1065Hmm.  
Model.NO.99.9806Y  
9806服务车



Dimension:560\*560\*1165Hmm.  
Model.NO.99.3215Y  
3215服务车



Dimension:1100\*600\*1310Hmm.  
Model.NO.99.9802TF  
房口车



Dimension:940\*590\*1160Hmm.  
Model.NO.99.7802  
房口车



Dimension:1020\*500\*1200Hmm.  
Model.NO.99.9811  
多功能车



Dimension:1020\*500\*1185Hmm.  
Model.NO.99.9811D  
多功能车



Dimension:1020\*500\*1190Hmm.  
Model.NO.99.9802T  
房口车



Dimension:1020\*500\*1190Hmm.  
Model.NO.99.7802T  
房口车



Dimension:1020\*500\*1190Hmm.  
Model.NO.99.9811DT  
多功能车



Dimension:1020\*500\*1190Hmm.  
Model.NO.99.9811T  
多功能车





Dimension:1200\*650\*1170Hmm.  
Model.NO.99.9812  
全铁酒水运送车



Dimension:1300 \*575 \*1115 Hmm.  
Model.NO.JW-CCTD



Dimension:660\*495\*860Hmm.  
Model.NO.JW-XC150



Dimension:1100\*640\*1200Hmm.  
Model.NO.90.9813  
酒水车



Dimension:1536 \*554\*1510Hmm.  
Model.NO.JW-HCF3



Dimension:940\*560\*835Hmm.  
Model.NO.90.3202H  
3202H不锈钢斜柱布草车



Dimension:605\*630\*1015Hmm.  
Model.NO.90.3203C  
3203C不锈钢折叠式布草车



Dimension:1100\*550\*1690Hmm.  
Model.NO.90.3300B  
不锈钢箱式送衣车



Dimension:1630\*560\*1790Hmm.  
Model.NO.90.3300HA/90.3300H(整装)  
3300HA不锈钢网式送衣车(拆装)



Dimension:940\*560\*830Hmm.  
Model.NO.90.3202  
3202不锈钢布草车



Dimension:940\*560\*830Hmm.  
Model.NO.99.3212C  
3212布草车



Dimension:1300\*650\*1825Hmm.  
Model.NO.90.3302  
台裙车



Dimension:1220\*600\*1700Hmm.  
Model.NO.90.3300Z  
3300Z不锈钢Z型挂杆送衣车



Dimension:925\*560\*910Hmm.  
Model.NO.90.3213  
3213不锈钢布草车



Dimension:925\*560\*910Hmm.  
Model.NO.99.3213BC1  
3213BC1网底布草车



Dimension:1220\*600\*1700Hmm.  
Model.NO.90.3300ZA  
3300ZA不锈钢Z型挂杆送衣车



Dimension:1220\*530\*1700Hmm.  
Model.NO.90.3300A  
不锈钢挂杆式送衣车





Dimension:1138\*600\*1740Hmm.  
Model.NO.99.3335D-1  
铝网格布巾车(带门)



Dimension:1138\*600\*1740Hmm.  
Model.NO.99.3335-1  
铝网格布巾车



Dimension:3200\*650\*830Hmm.  
Model.NO.90.3400  
不锈钢接单车(大)

Dimension:3000\*650\*830Hmm.  
Model.NO.90.3400S  
不锈钢接单车(小)



Dimension:1100\*615\*1880Hmm.  
Model.NO.92.2007H  
送衣柜车



Dimension:988\*500\*1725Hmm.  
Model.NO.99.3327  
3327层挂式布巾车





Dimension:1980\*1050\*660Hmm.  
Model.NO.99.2100C  
2100C豪华直立式加床



Dimension:1950\*930\*500Hmm.  
Model.NO.99.2200C  
2200C豪华折叠式加床



Dimension:1950\*920\*530Hmm.  
Model.NO.99.2400  
床头板自锁式简便折叠式海绵加床





Dimension:1930\*750\*470Hmm.  
Model.NO.99.2300  
自锁海绵压板折叠式加床



Dimension:1240\*720\*710Hmm.  
Model.NO.99.6000  
折叠式婴儿床

客房桶

订做产品示例图



不锈钢系列



Dimension:230x300Hmm.  
Model.NO.92.9220  
Dimension:270x190x290Hmm.  
Model.NO.90.1727  
Dimension:224x280Hmm.  
Model.NO.92.0240  
Dimension:270x190x295Hmm.  
Model.NO.92.0729  
Dimension:230x280Hmm.  
Model.NO.92.0230L  
Dimension:200x300Hmm.  
Model.NO.92.N200SA  
Dimension:230x280Hmm.  
Model.NO.92.0230  
材质厚度0.6mm



Dimension:230x280Hmm.  
Model.NO.90B.0230L / 92.0230L / 90R.0230L

Dimension:Φ230x260mm.  
Model.NO.91.0231 / 92.0231



Dimension: 224×280Hmm.  
Model.NO.92.0240  
Dimension: 270×190×295Hmm.  
Model.NO.92.0729



Dimension: Φ200×300Hmm.  
Model.NO.99.2028C



Dimension: Φ200×280Hmm.  
Model.NO.92.N200SQ



Dimension: Φ200×285mm.  
Model.NO.12.5000



Dimension: Φ200×300mm.  
Model.NO.92.9200T



Dimension: Φ250×280mm.  
Model.NO.92.9250T



Dimension: Φ230×315mm.  
Model.NO.99.9221



Dimension: Φ230×315mm.  
Model.NO.99.9221C(包皮革)



Dimension: Φ230×270Hmm.  
Model.NO.90.0210DSH

Dimension: Φ230×315Hmm.  
Model.NO.90.0210DH



Dimension: Φ224×280mm.  
Model.NO.99.0240C(包皮革)/99.0240



Dimension: 280×200×320mm.  
Model.NO.99.9331 / 99.9331C(包皮革)







Dimension:Φ230×260Hmm.  
Model.NO.99.0210DS

Dimension:Φ230×260Hmm.  
Model.NO.99.0210DSC  
(包皮革)

现有桶底尺寸: 215mm 220mm 230mm 240mm 250mm



Dimension:Φ230×315Hmm.  
Model.NO.99.0210D

Dimension:Φ230×315Hmm.  
Model.NO.99.0210DC  
(包皮革)



Dimension:Φ240×260mm.  
Model.NO.99.9221S

Dimension:Φ240×260mm.  
Model.NO.99.9221S-P / 99.9221SC-P

第一种: 加一个塑料内桶, 可以不使用垃圾袋更环保, 也不怕水质腐蚀, 更适合于KTV内使用。  
第二种: 不加塑料内桶, 使用垃圾袋, 不锈钢活动宽边圈有效将垃圾袋边隐藏。



Dimension:Φ280×Φ200×320mm.  
Model.NO.99.0733D

Dimension:Φ280×Φ200×320mm.  
Model.NO.99.0733DC  
(包皮革)



Dimension:235×165×292mm.  
Model.NO.96.9410B

Dimension:290×200×310mm.  
Model.NO.96.9420B

Dimension:265×190×324mm.  
Model.NO.96.9430B

Dimension:210×170×330mm.  
Model.NO.96.9480B

可选颜色



塑料包皮桶

桶身可选包皮与不包皮  
Dimension:290×200×310mm.  
Model.NO.96.9420YC  
Dimension:235×165×292mm.  
Model.NO.96.9410FC  
Dimension:265×190×324mm.  
Model.NO.96.9430RC



托盘 Tray

ABS塑料  
抗冲击\耐热\耐低温

Dimension:400×270×20mm.  
Model.NO.96.4027

Dimension:360×210×20mm.  
Model.NO.96.3421

Dimension:130×100×27H×40Hmm.  
Model.NO.96.1510

Dimension:Φ290×15mm.  
Model.NO.96.2929

Dimension:Φ295×15mm.  
Model.NO.96.0315



Dimension:460\*400\*1123Hmm.  
Model.NO.95.7504-1  
木质衣帽架



Dimension:460\*350\*1160Hmm.  
Model.NO.95.7502  
木质衣帽架



Dimension:590\*480\*1841Hmm.  
Model.NO.95.7503  
木质衣帽架



Dimension:820\*430\*1750Hmm.  
Model.NO.95.7505  
木质衣帽架



Dimension:820\*430\*1750Hmm.  
Model.NO.99.7505  
铁质衣帽架



Dimension:462\*220\*1119mm.  
Model.NO.95.7510  
木质衣帽架



Dimension:485\*330\*1040mm.  
Model.NO.95.7511  
木质衣帽架



Dimension:460\*400\*990Hmm.  
Model.NO.95.7501  
木质衣帽架



Dimension:435\*300\*1230Hmm.  
Model.NO.90.7516-1



Dimension:435\*350\*1230mm.  
Model.NO.90.7516



Dimension:425\*360\*1135Hmm.  
Model.NO.95.7509



- 行李架织带可选用尼龙织带、皮革
- 可根据酒店风格选用木质或五金材质的行李架
- 全部行李架都为折叠式，在运输成本上大为减少，同时在酒店做设备储备时，更为节省空间。
- 选用皮革为行李架带时，皮革可选



Dimension:600\*540\*500Hmm.  
Model.NO.90.3340RX  
不锈钢行李椅



Dimension:600\*500\*635mm.  
Model.NO.90.3350  
不锈钢行李椅



Dimension:600\*500\*635mm.  
Model.NO.99.3350  
铁制行李椅



Dimension:600\*550\*485Hmm.  
Model.NO.92.3340X  
不锈钢行李椅



Dimension:800\*490\*540mm.  
Model.NO.95.3359  
木制行李椅



Dimension:500\*400\*500mm.  
Model.NO.95.3356  
木制行李椅



Dimension:600\*450\*666mm.  
Model.NO.95.3350  
木制行李椅





# LOBBY EQUIPMENT

大堂用品系列-  
行李车/栏杆座/烟灰桶/指示牌

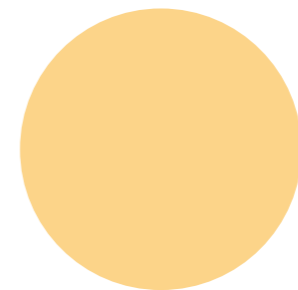
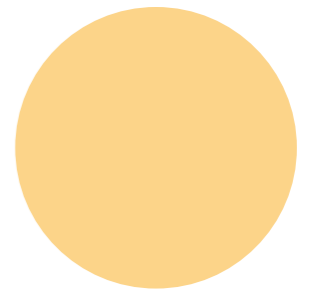
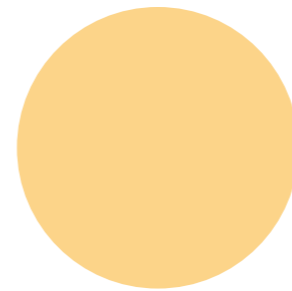
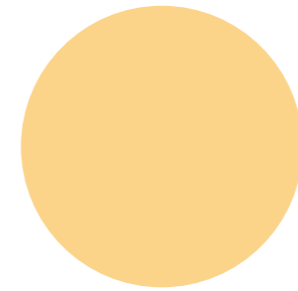
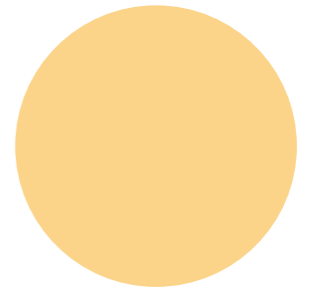
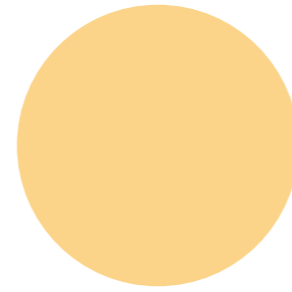
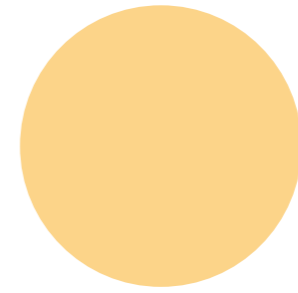



全车进行优化设计, 比例协调美观  
30台以上, 规格, 材质可由客户选择  
全车拆装, 减少运输体积, 易于部件售后服务

地毯有颜色可选, 可加拆换地毯

Black, red, blue, grey carpet are also available.



轮子可选 Wheels are available as below



Dimension: 1100\*615\*1980Hmm.  
Model.NO.92.2021SR  
行李车(红地毯)

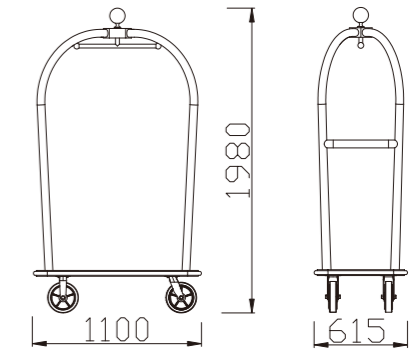

Dimension: 1100\*615\*1980Hmm.  
Model.NO.92.2021S  
行李车



Dimension: 1100\*615\*1980Hmm.  
Model.NO.91.2021S  
行李车



Dimension: 1100\*615\*1980Hmm.  
Model.NO.90.2021S  
行李车

管材可选#304, 处理有钛金, 黑金, 玫瑰金, 亮光, 砂光.  
铜管: 镜光, 砂光 钢材: 仿青铜, 古铜处理可选无指纹处理  
304# S/S tube, Finished options: titanium, niello, rose gold, mirror, brushed, antique brass and bronze.



\*例: 发一台整装车到北京运费需230元,  
发拆装包装车运费只需70元再加25元组装人工费  
拆装包装更省运费

www.sitty.com.cn

高品质 斯迪造 HIGH QUALITY MADE BY SITTY

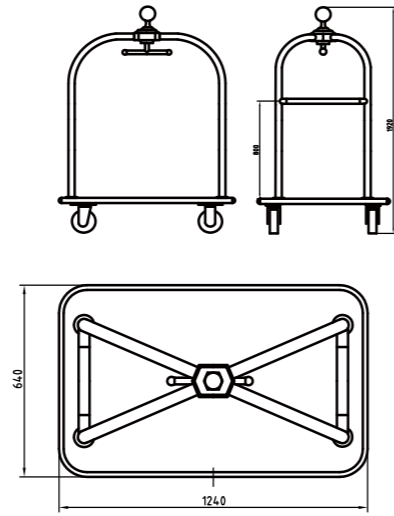

Dimension:1240\*640\*1920Hmm.  
Model.NO.91.2001A  
行李车



Dimension:1100\*615\*1770Hmm.  
Model.NO.92.2114AB  
行李车



Dimension:1100\*615\*1721Hmm.  
Model.NO.92.2104AB  
行李车



Dimension:1240\*640\*1920Hmm.  
Model.NO.90.2001A  
行李车



Dimension:1240\*640\*1920Hmm.  
Model.NO.92.2001AB  
行李车



Dimension:1000\*500\*900Hmm.  
Model.NO.90.2016  
不锈钢手推平板车



Dimension:903\*605\*860Hmm.  
Model.NO.JW-HD3624  
折叠手推平板车



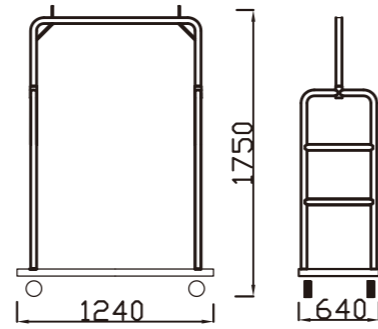

Dimension:1240\*640\*1750Hmm.  
Model.NO.92.2007A  
行李车



Dimension:1248\*648\*940Hmm.  
Model.NO.90.2008A  
2008镜光拆装散客箱包车



Dimension:1248\*648\*940Hmm.  
Model.NO.91.2008A  
2008钛金拆装散客箱包车



Dimension:1240\*640\*1750Hmm.  
Model.NO.90.2007A  
行李车



Dimension:1240\*640\*1750Hmm.  
Model.NO.91.2007A  
行李车



Dimension:1248\*648\*940Hmm.  
Model.NO.92.2008A  
2008砂光拆装散客箱包车

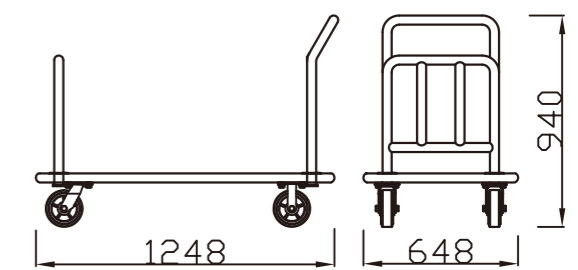



Dimension: 830\*560\*1230Hmm.  
Model.NO.90.2002  
2002手推不锈钢行李车



Dimension: 830\*560\*1230Hmm.  
Model.NO.91.2002  
2002手推不锈钢行李车

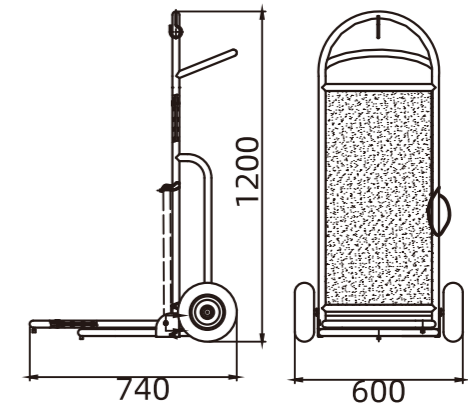

Dimension: 740\*600\*1200Hmm.  
Model.NO.91.2018  
2018手推不锈钢行李车



Dimension: 700\*560\*1200Hmm.  
Model.NO.90.2003  
2003手推不锈钢行李车

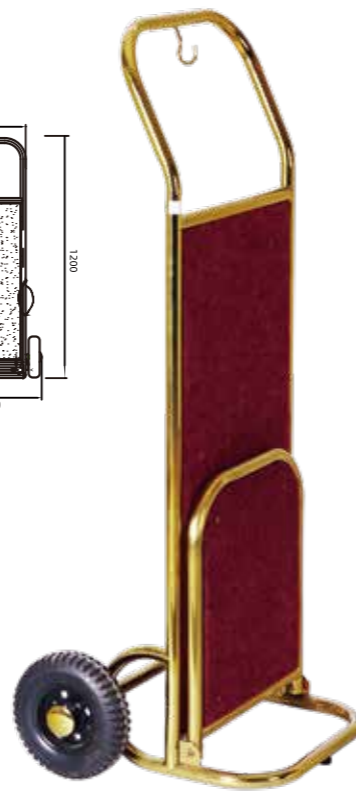
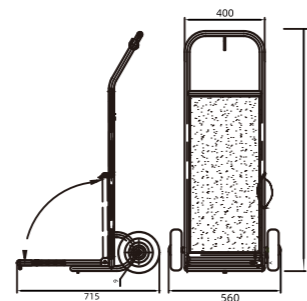

Dimension: 700\*560\*1200Hmm.  
Model.NO.91.2003  
2003手推不锈钢行李车



Dimension: 740\*600\*1200Hmm.  
Model.NO.90.2018  
2018手推不锈钢行李车



Dimension: 740\*600\*1200Hmm.  
Model.NO.92.2018  
2018手推不锈钢行李车





Dimension: 800\*580\*1200Hmm.  
Model.NO.92.2222K+TC2222R



Dimension: 870\*580\*1200Hmm.  
Model.NO.91.2102K



Dimension: 1240\*640\*1850mm.  
Model.NO.90.2007TWA



Dimension: 1240\*640\*1920mm.  
Model.NO.92.2010A



Dimension: 1100\*640\*1850mm.  
Model.NO.91.2111A



Dimension: 1240\*640\*1860mm.  
Model.NO.91.2005A



Dimension: 1248\*648\*1760mm.  
Model.NO.90.2004A



Dimension: 1240\*640\*1820mm.  
Model.NO.92.2112A



Dimension: 1100\*640\*1850mm.  
Model.NO.91.2009A



Dimension: 543\*730\*1200mm.  
Model.NO.91.2014

栏杆座配件

- 可选栏杆绳挂钩



- 可选栏杆绳

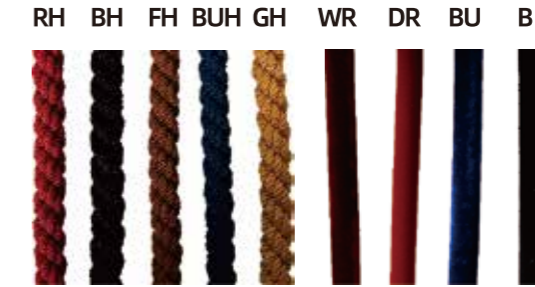

- 带织带的栏杆座，顾客可选择在织带上印刷企业LOGO，织带长度可选2.1m-3m

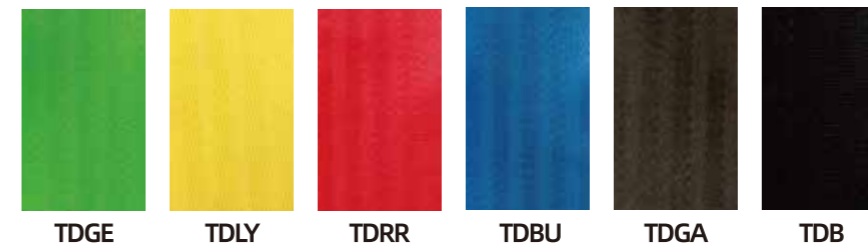

- 可选底盘



LOBBY  
EQUIPMENT

HANDRAIL  
BASE

www.sitty.com.cn



90.5101M8H+90.30A4L

92.5102H

90.5102H

91.5102H

Dimension:Φ310\*Φ50\*987Hmm  
Model.NO.90.5102H  
/91.5102H  
/92.5102H

Dimension:Φ310\*Φ50\*875Hmm  
Model.NO.90.5101M8H



Dimension:320\*218\*11mm.  
Model.NO.90.30A4



Dimension:305\*235\*11mm.  
Model.NO.90.30A4L



Dimension:Φ360\*Φ63\*950Hmm  
Model.NO.90.5490/91.5490/92.5490



Dimension:Φ310\*Φ63\*990Hmm  
Model.NO.90.5290H/91.5290H/92.5290H



91.5118H

90.5118H

92.5118H

Dimension:Φ310\*Φ50\*943Hmm  
Model.NO.90.5118H/91.5118H/92.5118H



Dimension:Φ300×Φ50×1270mm.  
Model.NO.92.5190+W5198+90.30A4



91.5190

90.5190

92.5190

Dimension:Φ310\*Φ50\*930Hmm  
Model.NO.90.5190/91.5190/92.5190



92.5190H

91.5190H

99.5190H

90.5190H

Dimension:Φ310\*Φ50\*993Hmm  
Model.NO.90.5190H/91.5190H/92.5190H/99.5190H

高品质 斯迪造 HIGH QUALITY MADE BY SITTY





Dimension:  $\Phi 360 \times \Phi 73 \times 1040$ Hmm  
Model.NO.90.5390



Dimension:  $\Phi 310 \times \Phi 50 \times 1012$ Hmm  
Model.NO.92.5690H



Dimension:  $\Phi 350 \times \Phi 63 \times 962$ Hmm  
Model.NO.90.5690

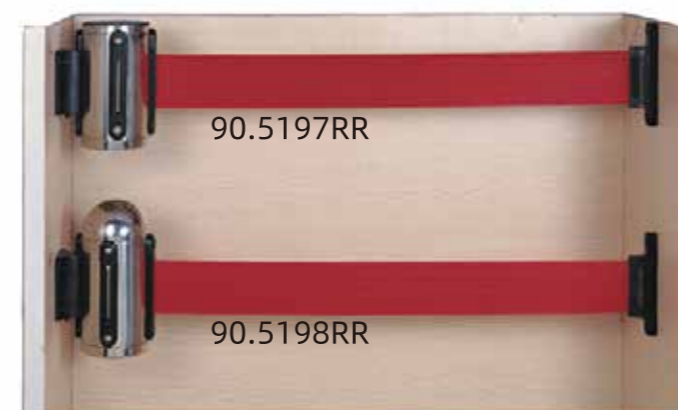

Dimension:  $80 \times 95 \times 120$ Hmm.  
Model.NO.90.5197RR

Dimension:  $80 \times 95 \times 140$ HHmm.  
Model.NO.90.5198RR

# LOBBY EQUIPMENT HANDRAIL BASE



Dimension:  $\Phi 360 \times \Phi 63 \times 918$ Hmm  
Model.NO.90.5490U



### 栏杆运送车

此款运送车可以方便批量运输较为重的栏杆。同时也可以作为存储工具，可谓是一物两用。每面可放置5pcs栏杆，双面都可放置。顶部可挂栏杆绳。



Dimension:  $1200 \times 700 \times 1800$ Hmm  
Model.NO.99.651270



Dimension: 560\*280\*710Hmm.  
Model.NO.99.1139D  
分类垃圾桶



Dimension: 580\*300\*680Hmm.  
Model.NO.99.1073D  
分类垃圾桶



Dimension: 520\*250\*620Hmm.  
Model.NO.92.1095D  
分类垃圾桶



Dimension: 600\*320\*680Hmm.  
Model.NO.92.1095DH  
分类垃圾桶



Dimension: 880\*330\*980Hmm.  
Model.NO.99.1138D  
分类垃圾桶



专利号: 201330424888.8  
Dimension: 450\*285\*800Hmm.  
Model.NO.99.1010D  
分类贴沙钢大堂垃圾桶



专利号: 201330424888.8  
Dimension: 450\*285\*800Hmm.  
Model.NO.99.1010DB  
分类大堂垃圾桶





专利号: 201330424876.5  
Dimension:446\*246\*650Hmm.  
Model.NO.99.1099D  
分类大堂垃圾桶



专利号: 201330424876.5  
Dimension:400\*310\*680Hmm  
Φ310\*75H  
Model.NO.92.1072DK+B310SB  
分类Z形大堂垃圾桶(双桶)



Dimension:300\*300\*680Hmm.  
Model.NO.95.1069B-1  
1069垃圾桶



Dimension:340\*340\*830Hmm.  
Model.NO.99.1868B  
1868B三角形黑身钢边户内垃圾桶



专利号: 201330424889.2  
Dimension:450\*250\*760Hmm.  
Model.NO.95.1935D  
室内分类镂花大堂垃圾桶



专利号: 201330424529.2  
Dimension:465\*300\*680Hmm.  
Model.NO.95.1069D  
室内分类镂花大堂垃圾桶



Dimension:300\*300\*760Hmm.  
Model.NO.99.1043  
1043方锥形垃圾桶



Dimension:320\*300\*680Hmm.  
Model.NO.99.1073  
1073创意Z型垃圾桶

室内分类垃圾桶系列

高品质 斯迪造 HIGH QUALITY MADE BY SITTY



Dimension:  $\Phi 360 \times 740$ Hmm.  
Model.NO.95.1186K+B360  
1186垃圾桶



Dimension:  $360 \times 310 \times 750$ Hmm.  
Model.NO.95.1080  
木质椭圆形垃圾桶



Dimension:  $200 \times 200 \times 600$ Hmm.  
Model.NO.99.1098  
方型铁质垃圾桶



Dimension:  $208 \times 208 \times 605$ Hmm.  
Model.NO.99.1192LB  
1192LB小方形钢头黑身垃圾桶



Tray Pack Size:  $36 \times 36 \times 20.5$ Hcm  
Dimension:  $280 \times 310 \times 760$ Hmm.  
Model.NO.92.1072K+B310SB  
砂光Z形垃圾桶



Dimension:  $300 \times 300 \times 650$ Hmm.  
Model.NO.91.1009YS(BF)-2  
四菱角钛金垃圾桶



Dimension:  $300 \times 250 \times 650$ Hmm.  
Model.NO.99.1077  
1077长方形垃圾桶



Dimension:  $290 \times 200 \times 615$ Hmm.  
Model.NO.99.1197B  
1197B长方形垃圾桶





Dimension:Φ380\*700Hmm.  
Model.NO.92.1038  
1038砂光不锈钢垃圾桶



Dimension:Φ305\*680Hmm.  
Model.NO.92.1079  
1038砂光不锈钢垃圾桶



Dimension:285\*285\*680Hmm..  
Model.NO.95.1034D  
1034D清秀型木质垃圾桶



Dimension:246\*246\*640Hmm.  
Model.NO.99.1099  
珍宝全黑垃圾桶



Dimension:246\*246\*650Hmm.  
Model.NO.99.1099AJ  
1099AJ珍宝埃及纹垃圾桶



Dimension:Φ340\*700Hmm.  
Model.NO.92.1039  
砂光翻盖不锈钢垃圾桶



Dimension:Φ250\*610Hmm.  
Model.NO.92.1095-1J  
1095-1砂光圆形垃圾桶



Dimension:Φ220\*620Hmm.  
Model.NO.99.1090B  
黑色有口圆型垃圾桶



Dimension:Φ220\*620Hmm.  
Model.NO.99.1090A  
灰色圆型有口垃圾桶



Dimension:Φ300\*Φ360\*780Hmm.  
Model.NO.99.1022H-1  
1022H-1锥柱圆座垃圾桶(盖为镜光)



Frame Size:510\*578mm  
Dimension:512\*356\*1465Hmm  
Model.NO.92.3026  
指示牌



Frame Size:440\*570Hmm  
Dimension:540\*350\*1530Hmm  
Model.NO.92.3486  
指示牌



Frame Size:440\*580mm  
Dimension:520\*350\*1515Hmm  
Model.NO.92.3488  
指示牌



Frame Size:440\*580mm  
Dimension:520\*350\*1515Hmm  
Model.NO.91.3488  
指示牌



Frame Size:280\*420mm  
Dimension:501\*351\*1350Hmm  
Model.NO.92.3485  
指示牌



Frame Size:640\*440Hmm  
Dimension:780\*580\*1445Hmm  
Model.NO.95.3481XFF  
指示牌



Frame Size:404\*704Hmm  
Dimension:900\*600\*1450Hmm  
Model.NO.95.3020  
指示牌



Frame Size:404\*704Hmm  
Dimension:900\*600\*1430Hmm  
Model.NO.91.3088  
指示牌





Frame Size:672\*455Hmm  
Dimension:640\*860\*1300Hmm  
Model.NO.91.3055  
指示牌



Frame Size:476\*308Hmm  
Dimension:550\*420\*1300Hmm  
Model.NO.99.3058-1  
指示牌



无边印效果型号: 90.300  
双面请勿泊车型号: 90.300NC  
请勿泊车/专用车位型号: 90.300SC  
双面专用车位型号: 90.300JC

Frame Size:416\*450Hmm  
Dimension:446\*520\*610Hmm  
Model.NO.90.300  
A字牌



Dimension:400\*170\*300Hmm  
Model.NO.91.4031  
资料架

书报架系列Newspaper Shelf



Frame Size:550\*420Hmm  
Dimension:400\*360\*1310Hmm/  
600\*400\*1110Hmm/  
600\*420\*1110Hmm  
Model.NO.95.3083  
指示牌



Frame Size:296\*296Hmm  
Dimension:400\*400\*1310Hmm  
Model.NO.95.3081  
指示牌



Dimension:340\*350\*1430Hmm  
Model.NO.99.5004  
5004四层弧形资料架



Dimension:310\*450\*1360Hmm  
Model.NO.99.5100  
资料架

雨伞架系列Umbrella Stand



Dimension:710\*400\*1330Hmm  
Model.NO.91.5000C  
5000C钛金书报架



Dimension:600\*470\*1500Hmm  
Model.NO.99.5910A  
5910A黑牡丹报纸架



Dimension:315\*210\*750Hmm  
Model.NO.92.9000C  
单头自动伞袋机



Dimension:482\*288\*780Hmm  
Model.NO.92.9001  
砂光双头伞袋机



Dimension:300\*360\*1250Hmm  
Model.NO.91.5009  
伞袋指示牌



Dimension:610\*500\*900Hmm  
Model.NO.99.5000  
铁质可拆式书报架



Dimension:630\*400\*1330Hmm  
Model.NO.99.5003  
5003书报架



Dimension:1060\*280\*810Hmm  
Model.NO.99.5036  
36头无锁雨伞架



Dimension:550\*280\*810Hmm  
Model.NO.99.5018  
18头无锁雨伞架



# keys box

## 钥匙箱系列



Dimension:510\*250\*800mm.  
Model.NO.11.98A5B



Dimension:520\*250\*905mm.  
Model.NO.11.GL6



Model.NO.11.B150



Model.NO.11.B024



Model.NO.11.B032



Model.NO.11.B048



11.B001GR 11.B001Y



11.B001OR 11.B001BU 11.B001R



Model.NO.11.B072



Model.NO.11.B096



Model.NO.11.B120



Dimension:1030\*630\*860mm.  
Model.NO.11.G601

# keys box

型号 Item No.	包装 PACKAGE QTY	外形 DIMENSION	外箱 MEAS	净重 NET WEIGHT	毛重 GROSS WEIGHT
11.98A5B	1/1	510*250*800MM	572*302*802MM	25KG	27KG
11.GL6	1/1	520*250*905MM	572*302*922MM	26KG	29KG
11.B024	1/10	322*205*52MM	670*340*240MM	15KG	16KG
11.B032	1/8	385*280*52MM	530*400*300MM	18KG	19KG
11.B048	1/6	558*280*52MM	580*400*300MM	19KG	20KG
11.B072	1/5	450*380*52MM	480*350*400MM	20KG	21.5KG
11.B096	1/4	590*380*52MM	610*270*410MM	21KG	22KG
11.B120	1/4	738*380*52MM	760*270*410MM	26KG	27KG
11.B150	1/3	738*415*70MM	760*270*450MM	21KG	22.5KG
11.G601	1/1	1030*630*860MM	915*860*210MM	17.37KG	19.2KG



# FOOD AND BEVERAGE EQUIPMENT

餐饮用品系列-

送餐车/酒水车/服务车/演讲台/宴会设施/

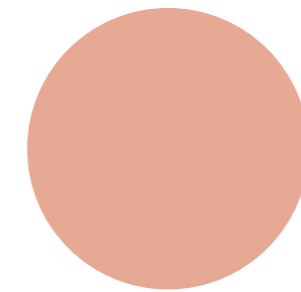
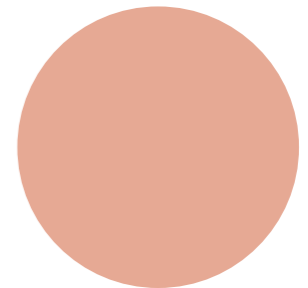
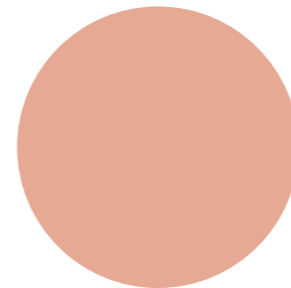
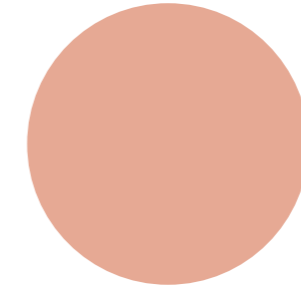
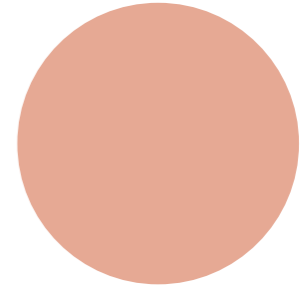
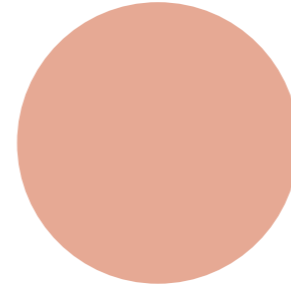
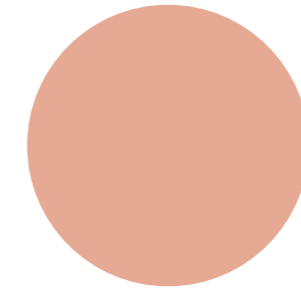



高品质 斯迪造 HIGH QUALITY MADE BY SITTY



Dimension:1090\*915\*750Hmm.  
 Model.NO.90.8302-1  
 8302改进型5折客房送餐车



Dimension:1100\*910\*750Hmm.  
 Model.NO.99.8329  
 送餐车



Dimension:1100\*910\*750Hmm.  
 Model.NO.90.8319A  
 送餐车



Dimension:1090\*915\*750Hmm.  
 Model.NO.90.8309A  
 送餐车



Dimension:1000\*900\*750Hmm.  
Model.NO.90.8319SQA  
送餐车



Dimension:430\*330\*490Hmm.(不含提手)  
Model.NO.92.8309E  
8309电热保温箱 220V

Dimension:380\*394\*510Hmm.(不含提手)  
Model.NO.92.8319E2(常规插头)  
/92.8319E1(美式插头)  
8319E2电热保温箱 220V 300w  
8319E1电热保温箱 110v 300w

保温箱形尺寸与内容汇总

序号	名称	L	W	H	dL	dW1	dW2	dW3	dW4	dH	fH1	fH2	fH3	fH4	备注
1	92.8309BC-1	430	327	470	400	309	309	309	\	440	130	142	147	\	
2	92.8309E	430	328	490	387	239	239	268	268	446	140	95	95	86	
3	92.8319E1	380	394	510	336	306	306	335	335	468	160	95	95	86	
4	92.8319E2	380	394	510	336	306	306	335	335	468	160	95	95	86	
5	92.8319SQ	380	394	510	336	360	360	360	360	468	160	95	95	86	
6	MGM8309HD	380	364	510	336	360	300	360	330	468	160	95	95	86	

<p>所有尺寸不含提手 尺寸适用于 92.8309BC 92.8309BC-1</p>	<p>尺寸适用于 92.8319SQ (下有酒精限位环, 同后图) 92.8319E1 92.8319E2 92.8319E</p>	<p>尺寸适用于 MGM8309HD</p>
---	--	----------------------------

保温箱、餐桌、保温箱运输车的配套说明:

- 1、90.8309A可放配套保温箱92.8309E与92.8309BC-1
- 2、90.8319SH、908319SQA、90.8919A、99.8329、90.8302-1  
可放配套保温箱92.8319E1、92.8319E2、92.8319SQ
- 3、MGM8309HD、MGM8309只能单独使用





高品质 斯迪造 HIGH QUALITY MADE BY SITTY



Dimension:380\*394\*510Hmm.(不含提手)  
Model.NO.92.8319E2B(常规插头)  
8319E2黑色电热保温箱 220V 300w



Dimension:1120\*515\*1753Hmm.  
Model.NO.90.83195H  
保温箱层架车 (图配92.8319)



Dimension:380\*364\*510Hmm.  
Model.NO.MGM8309HD  
有拉手带轮保温箱

[www.sitty.com.cn](http://www.sitty.com.cn)

[www.sitty.com.cn](http://www.sitty.com.cn)





高品质 斯迪造 HIGH QUALITY MADE BY SITTY



Dimension:460\*400\*780Hmm.  
Model.NO.99.8107BH  
铁质圆形酒水车



Dimension:453\*400\*870Hmm.  
Model.NO.95.8192  
木质酒水车



Dimension:400\*400\*800Hmm.  
Model.NO.95.8191  
木质酒水车



Dimension:430\*430\*780Hmm.  
Model.NO.95.8145  
圆盘酒水车



Dimension:520\*520\*780Hmm.  
Model.NO.95.8146  
方盘酒水车



Dimension:Φ530\*855Hmm.  
Model.NO.95.8107  
木质酒水车



Dimension:480\*400\*864Hmm.  
Model.NO.95.8107BS  
木质酒水车





Dimension:720\*480\*810Hmm.  
Model.NO.95X.8568  
防火板香槟金酒水车



Dimension:720\*480\*810Hmm.  
Model.NO.953.8568B.3  
防火板砂光金酒水车



Dimension:900\*500\*822Hmm.  
Model.NO.91.8102S  
钛金酒水车



Dimension:930\*480\*870Hmm.  
Model.NO.95.8111  
木质酒水车



Dimension:720\*480\*810Hmm.  
Model.NO.953.8568B.3H  
防火板砂光金酒水车



Dimension:720\*480\*810Hmm.  
Model.NO.952.8568B  
防火板砂光酒水车



Dimension:920\*500\*890Hmm.  
Model.NO.95.8129  
豪华宫廷式酒水车



Dimension:942\*460\*915Hmm.  
Model.NO.95.8121  
双层酒水车



服务车系列 Service Cart



Dimension:878\*632\*943Hmm.  
Model.NO.95.8114  
木质酒水车



Dimension:910\*740\*880Hmm.  
Model.NO.95.8115  
木质酒水车



Dimension:924\*510\*859Hmm.  
Model.NO.95.8236  
木质酒水车



Dimension:955\*510\*800Hmm.  
Model.NO.95.8565  
三层服务车



Dimension:1200\*655\*840Hmm.  
Model.NO.95.8133  
木质椭圆餐车



Dimension:900\*490\*1020/870Hmm.  
Model.NO.95.8612+L103  
凉菜车 (2件套)

Dimension:880\*460\*856Hmm.  
Model.NO.95.8896  
木质酒水车



Dimension:1125\*460\*856Hmm.  
Model.NO.95.8896-1Z  
服务车



Dimension:976\*500\*892Hmm.  
Model.NO.95.8190  
三层服务车



高品质 斯迪造 HIGH QUALITY MADE BY SITTY



Dimension:950\*460\*830Hmm.  
Model.NO.90.8113  
三层服务车



Dimension:860\*446\*943Hmm.  
Model.NO.90.8333-1  
三层不锈钢酒水车



Dimension:725\*440\*970Hmm.  
Model.NO.90.8304A  
餐盘车



Dimension:640\*460\*830Hmm.  
Model.NO.90.8234  
二层酒水车



Dimension:980\*530\*930Hmm.  
Model.NO.JW-SEDO



Dimension:420\*760\*900Hmm.  
Model.NO.JW-FC2115



Dimension:539\*324\*750Hmm.  
Model.NO.90.8303S  
三层火锅服务车

Dimension:540\*330\*840Hmm.  
Model.NO.90.8303  
四层火锅服务车



Dimension:750\*460\*980Hmm.  
Model.NO.90.8232  
三层酒水车

高品质 斯迪造 HIGH QUALITY MADE BY SITTY



Dimension:550\*550\*850Hmm.  
Model.NO.95.8177  
服务柜



Dimension:1000\*550\*1410Hmm.  
Model.NO.95.8179A  
服务柜



Dimension:355\*560\*1005Hmm.  
Model.NO.D95D  
防火板服务台(拆装)



Dimension:355\*560\*1005Hmm.  
Model.NO.D95D  
防火板服务台(拆装)



Dimension:885\*580\*1050Hmm.  
Model.NO.95.8176-6  
木质服务台



Dimension:884\*562\*1050Hmm.  
Model.NO.95.8176FHA-1  
防火板服务台(拆装)



www.sitty.com.cn

www.sitty.com.cn



可搭配煤气单炉或者卡式炉



Dimension:1040\*613\*850Hmm.  
Model.NO.95.8508  
防火板双炉煮热车



Dimension:850\*504\*885Hmm.  
Model.NO.95X.8569  
防火板香槟金单炉煮热车



Dimension:850\*504\*825Hmm.  
Model.NO.953.8569G

可搭配煤气单炉或者卡式炉



Dimension:1120\*640\*850Hmm.  
Model.NO.95.8502K+LS2-1  
木质煮热车



Dimension:850\*504\*825Hmm.  
Model.NO.952.8569G



Dimension:720\*480\*810Hmm.  
Model.NO.952.8568BG

餐饮用品牛肉车系列 Buffet cart

高品质 斯迪造 HIGH QUALITY MADE BY SITTY



Dimension:1376×500×802mm.  
Model.NO.95.8562DK+LS2-1  
双炉煮热车



Dimension:887\*640\*1065Hmm.  
Model.NO.95.8803  
牛肉车



Dimension:1100\*520\*804Hmm.  
Model.NO.95.8563SK+LS1-1  
煮热车



Dimension:1110\*520\*800Hmm.  
Model.NO.95.8564SK+LS1-1  
单炉煮热车



Dimension:928\*630\*1110Hmm.  
Model.NO.95.8802  
牛肉车





# FOOD AND BEVERAGE EQUIPMENT

餐饮用品系列-  
演讲台/自助餐/宴会设施



Dimension:519\*426\*1033Hmm.  
Model.NO.95.9034  
演讲台



Dimension:519\*426\*1005/1200Hmm.  
Model.NO.95.9034SJ  
升降演讲台



Dimension:519\*426\*1033Hmm.  
Model.NO.95.9034B  
演讲台



Dimension:519\*426\*1005/1200Hmm.  
Model.NO.95.9034BSJ  
升降演讲台

高品质 斯迪造 HIGH QUALITY MADE BY SITTY



Dimension:600\*513\*1260mm.  
Model.NO.95.9033-1  
升降演讲台



Dimension:600\*513\*1260Hmm.  
Model.NO.95.9035  
手摇升降演讲台



Dimension:592\*495\*1177Hmm.  
Model.NO.95.9002  
演讲台



Dimension:750\*450\*1150Hmm.  
Model.NO.95.9010  
演讲台



Dimension:535\*488\*1177Hmm.  
Model.NO.95.9023EKV-1  
演讲台



Dimension:490\*490\*1170Hmm.  
Model.NO.95.9023A  
演讲台



Dimension:490\*490\*1170Hmm.  
Model.NO.95.9023FF-1A  
演讲台



可选无花



Dimension:735\*545\*1285Hmm.  
Model.NO.95.9011-1  
演讲台



Dimension:606\*455\*1205Hmm.  
Model.NO.95.9012  
演讲台





自助餐系列 Buffet Series

高品质 斯迪造 HIGH QUALITY MADE BY SITTY



Dimension:520\*450\*1133Hmm.  
Model.NO.95.9004  
演讲台



Dimension:450\*500\*1118Hmm.  
Model.NO.95.9029B  
演讲台



Model.NO.95.9028A

Model.NO.95.9028B

Dimension:600\*506\*1156Hmm.  
Model.NO.95.9028A/95.9028B  
演讲台



Model.NO.95.9030B

Dimension:636\*468\*1100Hmm.  
Model.NO.95.9030A/95.9030B  
演讲台



95.8156-2  
双重选择:  
可选增加加热保温系统, 外观基本无变化

Dimension:1200\*700\*1620Hmm.  
Model.NO.95.8159  
豪华带灯光效果操作餐台



Dimension:605\*425\*715Hmm.  
Model.NO.90.BF120  
石面不锈钢支架带双头暖灯



Dimension:1600\*650\*1921Hmm.  
Model.NO.95.8156-1  
煮热车



Dimension:1260\*686\*995-1595Hmm.  
Model.NO.92.8239  
LED电磁炉车



高品质 斯迪造 HIGH QUALITY MADE BY SITTY



Dimension:1530\*800\*1545Hmm.  
Model.NO.92.8165  
冷盘车



Dimension:650\*650\*1200/  
550\*550\*1000Hmm.  
Model.NO.92.BF015  
2层组合砂光不锈钢钢化  
玻璃自助餐台(2件套)



Dimension:550\*550\*1210Hmm.  
Model.NO.99.645512  
Dimension:900\*900\*760Hmm.  
Model.NO.99.649076  
交叉折叠自助餐盘台



① Dimension:Φ750X1100Hmm.  
Model.NO.90.649100  
② Dimension:Φ650X800Hmm.  
Model.NO.90.649101  
③ Dimension:Φ550X600Hmm.  
Model.NO.90.649102  
不锈钢圆形餐台



Dimension:640\*400\*480mm  
720\*400\*630mm  
800\*400\*770Hmm.  
Model.NO.92.BF003  
3层组合砂光不锈钢钢化  
玻璃自助餐台(2件套)

Dimension:1220\*600\*500Hmm  
1310\*600\*640Hmm  
1400\*600\*780Hmm.  
Model.NO.92.BF004  
3层组合砂光不锈钢钢化  
玻璃自助餐台(2件套)



Dimension:2440×1830×610 / 410mm.  
Model.NO.99.6003  
大号活动舞台

Dimension:2440×1220×610 / 410mm.  
Model.NO.99.6003S  
小号活动舞台



Dimension:φ63x550\*760/  
φ63x550\*1100Hmm.  
Model.NO.92.663550S  
/92.663550SG



Dimension:φ63x550\*760/  
φ63x550\*1100Hmm.  
Model.NO.92.663550  
/92.663550G



Dimension:φ63x550\*760/  
φ63x550\*1100Hmm.  
Model.NO.92.663550F  
/92.663550FG



Dimension:605\*500\*500Hmm.  
Model.NO.99.6010  
活动舞台二级梯



Dimension:605\*750\*710Hmm.  
Model.NO.99.6013  
活动舞台三级梯



高品质 斯迪造 HIGH QUALITY MADE BY SITTY

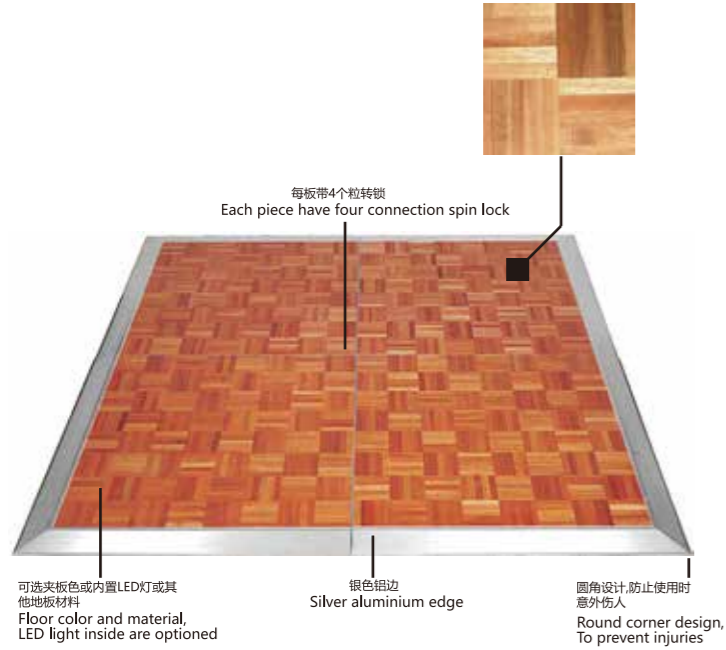

Dimension:925×925×22mm.  
Model.NO.95.69191  
跳舞板



Dimension:1300\*750\*1050mm.  
Model.NO.99.671375  
跳舞板运输车



Dimension:650\*600\*1150Hmm.  
Model.NO.99.2301  
餐椅运送车



Dimension:810\*400\*860mm.  
Model.NO.91.6111  
摇奖箱



Dimension:1540\*1040\*1150Hmm.  
Model.NO.99.7601  
餐桌运输车



Dimension:1200\*650\*1485Hmm.  
Model.NO.99.7603  
玻璃转盘运输车(2件/套)



Dimension:2145\*750\*905Hmm.  
Model.NO.99.2075  
餐椅运送车

高品质 斯迪造 HIGH QUALITY MADE BY SITTY



Dimension:470\*440\*760Hmm.  
Model.NO.95.3353  
木质餐盘架



Dimension:400\*400\*800Hmm.  
Model.NO.95.3357  
木质餐盘架



Dimension:400\*419\*800Hmm.  
Model.NO.90.3358  
蛋扁管不锈钢餐盘架



Dimension:500\*300\*800Hmm.  
Model.NO.90.3352  
3352不锈钢餐盘架



Dimension:470\*430\*860Hmm.  
Model.NO.90.3353  
3353不锈钢餐盘架



Dimension:410\*570\*890mm.  
Model.NO.99.6100



Dimension:450W\*520D\*460SH\*930SHmm.  
Model.NO.98.1911



Dimension:470W\*520D\*460SH\*940SHmm.  
Model.NO.98.1910



Dimension:450W\*500D\*460SH\*930SHmm.  
Model.NO.99.1902G



Dimension:450W\*520D\*460SH\*930SHmm.  
Model.NO.98.1906



Dimension:450W\*520D\*460SH\*930SHmm.  
Model.NO.98.1909



高品质 斯迪造 HIGH QUALITY MADE BY SITTY



-MOQ:20PCS

Dimension:800×800×1100mm.  
Model.NO.99.648011BG



-MOQ:20PCS

Dimension:800×800×1130mm.  
Model.NO.99.668011BG



-MOQ:20PCS

Dimension:1220×610×760mm.  
Model.NO.99.641261BG



Dimension:φ1530×760mm.  
Model.NO.99.1500FDBG



Dimension:915\*915\*760Hmm.  
Model.NO.99.9191S  
正方台



Dimension:Φ1520/2\*760Hmm.  
Model.NO.99.1576H  
半圆餐桌



Dimension:800×800×1100mm.  
Model.NO.99.648011



Dimension:1220×610×760mm.  
Model.NO.99.641261BG



Dimension:1530×600×1030/760mm.  
Model.NO.99.611530BG



Dimension:Φ1516\*760Hmm.  
Model.NO.99.1530R  
圆形餐桌

99.1530R底面

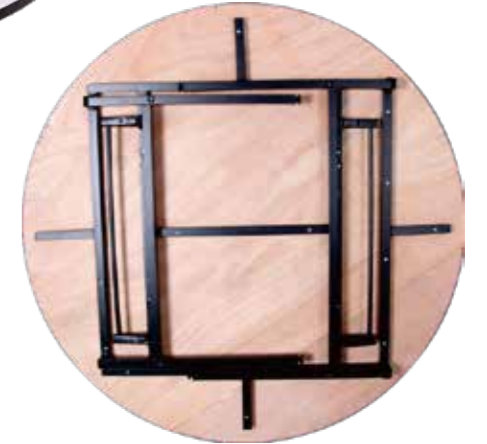

99.611876展开图







Dimension:1530×600×1030/760mm.  
Model.NO.99.611876TW



99.1530TR底面

Dimension:Φ1530\*760Hmm.  
Model.NO.99.1530TR  
翻转台

折叠台  
FOLDING TABLE

	型号/Model NO	尺寸/DIMENSIONS	G.W	体积/VOLUMN
	99.2591C	2.58X0.915m <small>外径:3660 内直径:1830 拼成圆环所需数量: 4pcs</small>	2pcs/ctn 86kg	0.72509
	99.2191C	2.10X0.915m <small>外径:5490 内直径:3660 拼成圆环所需数量: 8pcs</small>	2pcs/ctn 78kg	0.59150
	99.2291C	2.26X0.915m <small>外径:7320 内直径:5490 拼成圆环所需数量: 10pcs</small>	2pcs/ctn 84kg	0.63610
	99.2391C	2.366X0.915m <small>外径:9150 内直径:7320 拼成圆环所需数量: 12pcs</small>	2pcs/ctn 86kg	0.66900
	99.2176C	2.15X0.76m	2pcs/ctn 59kg	0.50780
	99.2276C	2.28X0.76m <small>外径:4570 内直径:3050 拼成圆环所需数量: 6pcs</small>	2pcs/ctn 63kg	0.53820
	99.2376C	2.326X0.76m <small>外径:6090 内直径:4570 拼成圆环所需数量: 8pcs</small>	2pcs/ctn 70kg	0.54870
	99.2476C	2.348X0.76m <small>外径:7610 内直径:6090 拼成圆环所需数量: 10pcs</small>	2pcs/ctn 70kg	0.55460
	99.2476T	2.44X0.76m	2pcs/ctn 40kg	0.28782
	99.1876T	1.83X0.76m	2pcs/ctn 59.5kg	0.30303
	99.1576T	1.53X0.76m	2pcs/ctn 50kg	0.252252
	99.2445T	2.44X0.45m	2pcs/ctn 64kg	0.17343
	99.1845T	1.83X0.45m	2pcs/ctn 49.2kg	0.1956375
	99.1545T	1.53X0.45m	2pcs/ctn 45kg	0.152985
	99.1891T	1.83X0.915m	2pcs/ctn 64.7kg	0.361305
	99.1591T	1.53X0.915m	2pcs/ctn 56kg	0.302715
	99.1245T	1.22X0.45m	2pcs/ctn 36kg	0.17480
	99.1276T	1.22X0.76m	2pcs/ctn 42kg	0.29020
99.1291T	1.22X0.915m	2pcs/ctn 50kg	0.34596	
	99.1891H	1.83X0.915m		
	99.1576H	1.53X0.76m	2pcs/ctn 47.5kg	0.252252
	99.2010H	2.0X1.0m		
	99.2211H	2.2X1.1m	1pcs/ctn 36kg	0.29840
	99.2412H	2.4X1.2m	1pcs/ctn 27kg	0.35430
	99.10760	1.08(W)X0.76m	2pcs/ctn 40kg	0.36300
	99.10910	1.29(W)X0.915m	2pcs/ctn 44.5kg	0.51480
	99.0760R	Ø760x760m	2pcs/ctn 28kg	0.18250
	99.0915R	Ø915x760m	2pcs/ctn 46kg	0.25950
	99.2200R	Ø2200x760m	1pcs/ctn 23kg	0.464255
	99.2000R	Ø2000x760m	1pcs/ctn 63.5kg	0.38437
	99.1830R	Ø1826x760m	1pcs/ctn 59kg	0.3223995
	99.1600R	Ø1600x760m	2pcs/ctn 82kg	0.43263
	99.1530R	Ø1516x760m	2pcs/ctn 38kg	0.39095
	99.1220R	Ø1220x760m	2pcs/ctn 60kg	0.3621048
99.0610R	Ø610x760m	2pcs/ctn 17.5kg	0.09346995	

型号/Model NO: 99.1830TR

	价格/Price	
	尺寸/Dimensions	Ø1830X760mm
	G.W	1pcs/ctn 44kg
	体积/Volumn	0.8m³
	产品特点	可折叠圆桌

型号/Model NO: 99.1530TR

	价格/Price	
	尺寸/Dimensions	Ø1530X760mm
	G.W	2pcs/ctn 37kg
	体积/Volumn	1.63m³
	产品特点	可折叠圆桌

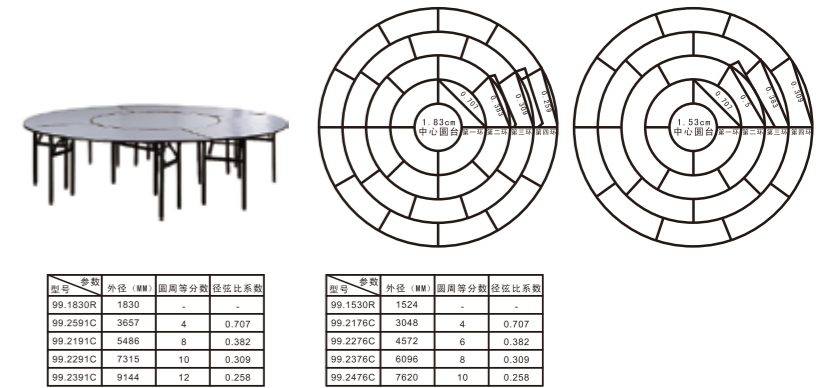

型号	外径 (MM)	圆环等分数	径弦比系数
99.1830R	1830	-	-
99.2591C	3657	4	0.707
99.2191C	5486	8	0.382
99.2291C	7315	10	0.309
99.2391C	9144	12	0.258

型号	外径 (MM)	圆环等分数	径弦比系数
99.1530R	1524	-	-
99.2176C	3048	4	0.707
99.2276C	4572	6	0.382
99.2376C	6096	8	0.309
99.2476C	7620	10	0.258

- 报价及计算方法:**
- 确定等分数: 依客户要求直径, 选择与我司常规尺寸接近的规格等分;
  - 确定弦长: 客户要求直径 X 径弦比系数 = 餐台弦长 (弦长不能超过限度 2440mm);
  - 确定径长: 径长可在那里 650 ~ 910mm 范围内进行选择;
  - 确定径长, 即可定出下一环餐台弦长及径长;
  - 确定中心圆台: 中心圆台直径范围在家 1220~1830mm 之间为宜。



Dimension:915\*915\*760Hmm.  
Model.NO.99.1845FA  
长方台



Dimension:1830\*450\*760Hmm.  
Model.NO.99.1845BM  
长方台

# FOLDING TABLE





Dimension:530\*530\*1080Hmm.  
Model.NO.99.1772F  
户外垃圾桶



Dimension:530\*530\*1080Hmm.  
Model.NO.99.1772GE  
户外垃圾桶



Dimension:Φ480\*725Hmm.  
Model.NO.99.1721LR  
户外垃圾桶



Dimension:Φ480\*725Hmm.  
Model.NO.99.1721LB1  
户外垃圾桶



Dimension:Φ480\*770Hmm.  
Model.NO.99.1721LA1  
户外垃圾桶

# Outdoors EQUIPMENT Dustbin



Dimension:477\*260\*890Hmm.  
Model.NO.99.1732Y  
1732户外垃圾桶



Dimension:350\*350\*820Hmm.  
Model.NO.99.1935SZ  
户外垃圾桶



Dimension:380\*380\*955Hmm.  
Model.NO.99.1729  
户外垃圾桶



Dimension:330\*280\*895Hmm.  
Model.NO.99.1894  
户外垃圾桶



Dimension:477\*260\*890Hmm.  
Model.NO.99.1732F  
1732F户外垃圾桶



Dimension:380\*380\*955Hmm.  
Model.NO.99.1135  
户外垃圾桶



Dimension:380\*380\*955Hmm.  
Model.NO.99.1793  
户外垃圾桶



Dimension:380\*380\*955Hmm.  
Model.NO.99.18039  
户外垃圾桶



Dimension:477\*260\*890Hmm.  
Model.NO.99.1731GE  
1731GE户外垃圾桶



Dimension:380\*380\*955Hmm.  
Model.NO.99.18025  
户外垃圾桶



Dimension:395\*395\*795Hmm.  
Model.NO.99.1119  
户外垃圾桶



Dimension:380\*380\*955Hmm.  
Model.NO.99.1893  
户外垃圾桶