



**GUANGZHOU PERFECT CO.,LTD.**



**CATALOG  
2018-2019**

# Enterprise Profile

Guangzhou Perfect Co., Ltd was established in 2001, which specializes in Research, Development, Production, and Sales of Metal & Plastic Merchandise for Hotel, Bar, Oriental & Western Kitchens.

Guangzhou Perfect Co., Ltd has its own factory covering an area of 20,000 square meters. There are some departments including Technical development, Molding, Hardware, Injection, Rotation and Packing. Based on our strong economic strength, we have introduced some advanced facilities & technologies for future achievement.

Guangzhou Perfect Co., Ltd has a group of high-tech professionals with over ten years' experience in product research and development. Matching an united, progressive, disciplined and pragmatic sales team. We concentrate on product design, research & development, production and marketing. Also on providing satisfied-services and high-quality goods to our customers. Meanwhile, we are recognized as a leader in this field .developing our enterprise culture to enhance our core competitiveness and to build a good social image.

Guangzhou Perfect Co., Ltd is absorbed in building up long-term partnerships with our employees, suppliers and clients, ensuring to exceed customers' expectation of our services, quality, value and dependability.

After we have received many awards of product innovation and being recognized by our outstanding services . Moreover, our own brand **JJWINS®** is widely accepted by our customers and has obtained public praise from this field.

Adhere to people-oriented, mutual Win-Win business philosophy, we have been working with comprehensive partners over 80 countries in the worldwide market. We wish more opportunities could be provided to you with our excellent services.



# CONTENTS

## Glass Racks Products

Glass Racks & Cup Keepers ..... 01-09

## Storage Products

GN PAN ..... 10-12  
 Square Storage Container ..... 13-14  
 Round Storage Container ..... 15-17  
 Food Storage Box ..... 17-18  
 Food Storage Pan Sliding Lid ..... 19  
 Food Preparation Pan ..... 19  
 Beverage Dispenser ..... 19  
 Ingredient Bins ..... 20  
 Shelf Ingredient Bins ..... 20  
 Dough Storage Box ..... 21  
 Ingredient Container ..... 22  
 Salad Spinner ..... 23  
 Versa Organizers ..... 24

## Tabletop Products

Beverage Tumblers ..... 26-31  
 Fast Food Trays ..... 33-32  
 Buffetwares ..... 34-39  
 Food Covers ..... 40

## Barwares Products

Plastic Barware ..... 41-45

## Shelving Products

Aluminum Composite Shelvings.. 46-50  
 Winshelvings ..... 51-64  
 Wire Shelvings ..... 65-68

## Faucet Products

Mounted Faucet ..... 70-71  
 Pot and Kettle Filler ..... 72  
 Wall munted Retractable  
 Hose Reel ..... 73  
 Workboard and Pantry Faucets... 74-78  
 Waste Valves ..... 79  
 Faucet Accessories ..... 80

## Insulated Transport Products

Drink Server ..... 82  
 EPP Insulated Pan Carrier ..... 83-84  
 Ultra carts Food Pan ..... 85  
 Insulated Pan ..... 86  
 Sliding Ice Caddy ..... 86

## Food Service Cart Products

Plate Rack ..... 88-90  
 Wall Mount Plate Rack ..... 91  
 26 Sheet Pan Rack ..... 92  
 Tray Table Ware Cart ..... 93  
 Mutiduty Service Cart ..... 94  
 Collapsible Laundry Cart ..... 95  
 Folding Cart ..... 96  
 Heavy-duty Platform Trucks ..... 97

## Baby Chair

Dinner Chair ..... 99  
 Baby Chair ..... 99

## Cleaning Products

Compact Cleaning Cart ..... 110  
 Luxury Compact Cleaning Cart ... 101  
 Multifunctional Cleaning Cart ..... 102  
 High Capacity Cleaning Cart ..... 103  
 Triple Capacity cart ..... 103  
 Innovative Cleaning Cart ..... 104  
 Luxury Cleaning Cart ..... 105  
 Medical Places Special  
 Cleaning Cart ..... 105  
 Accessories ..... 106  
 Housekeeping Cart ..... 107  
 Step-on Container ..... 108  
 Recycling Slim Container ..... 109  
 Vented Channel Container ..... 110  
 Recycle Round Container ..... 111  
 Cleaning Tool ..... 112  
 Hotel & Kitchen Utensil ..... 113

## Product Index

Product Index ..... 114-119

\*This booklet and dimensions are for reference only, please according to the real object.

## New Product



Glass Racks 02



Glass & Cup Keepers 08



PP GN Pan 11



Salad Spinner 23



Mobile Plate Rack 88



Salad Clip 36



Squeeze Dispenser 42  
(Wide Mouth)



Dipperwell Bowl 79



EPP Insulated Pan Carrier 83

# Glass Racks

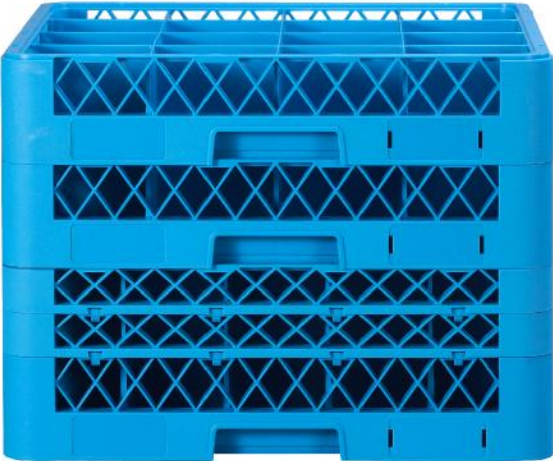



# Glass Racks

## Features

Needs no second wash, efficiently saving time and cost.  
Make the glassware cleaner.

### Open Profile

Allows top-to-bottom and side-to-side washing, making the glassware cleaner. Allows more air to circulate through the racks and makes faster drying and safer storing.

### Stackability

Snap-fit construction shortens assembly time, and stacks all racks tightly.

### Tight Connection

Snap-fit extenders will not loosen or rust over time like screws and will not come apart.

### Guide Cards Groove

Color cards can be inserted into different colors to facilitate identifying and storing items and improve work efficiency.

### Convenient Handle

The handles on all four sides of the racks are convenient for safe delivery. Textured surface and convenient handles can avoid scratches when carried.

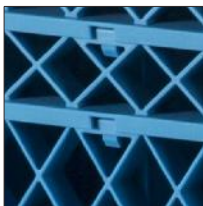
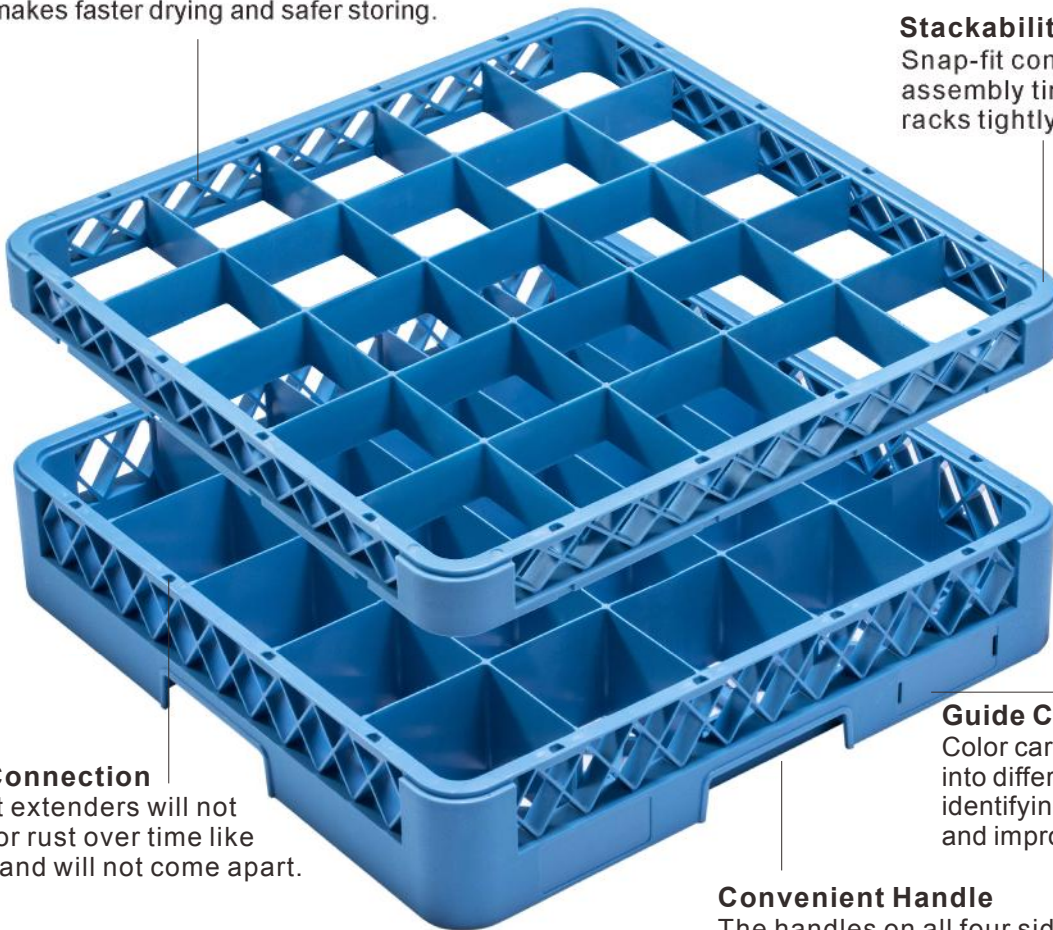

# Glass Racks

## Glass Rack Sizing Guide Instruction

1. Place glass upside down on top of the middle circle of the sizing guide, center of the glass should be over the center of the guide.
2. Look down on the base of the glass.
3. Note the smallest square on the guide where the largest outside diameter of the glass lines up completely within the square without touching it. That is the number of compartments our rack needs to have.
4. Place lip of glass against the base line of the vertical guide on the right-hand side of the page with the base/foot of the glass pointing straight up towards the top of the page.
5. While holding the glass against the vertical guide, note where the base/foot of the glass lines up on the vertical guide. The next line above the base/foot on the guide indicates the number of extenders your rack will require.
6. Glasses with a maximum height exceeding 270mm will need more than five extenders. Each extender adds approximately 40mm of additional height to the inside compartment of the rack.

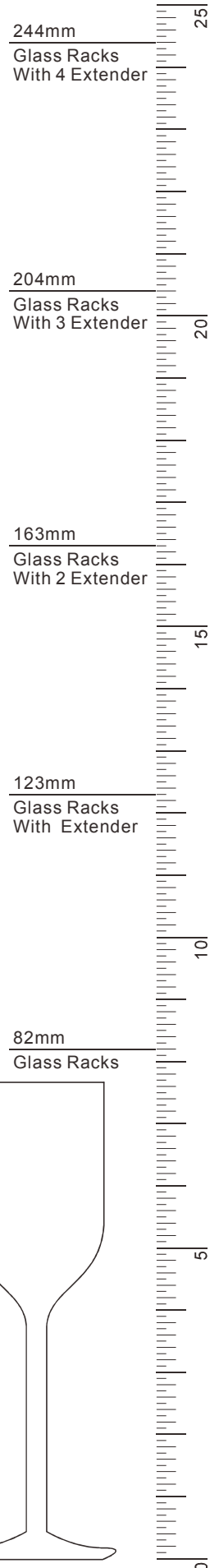
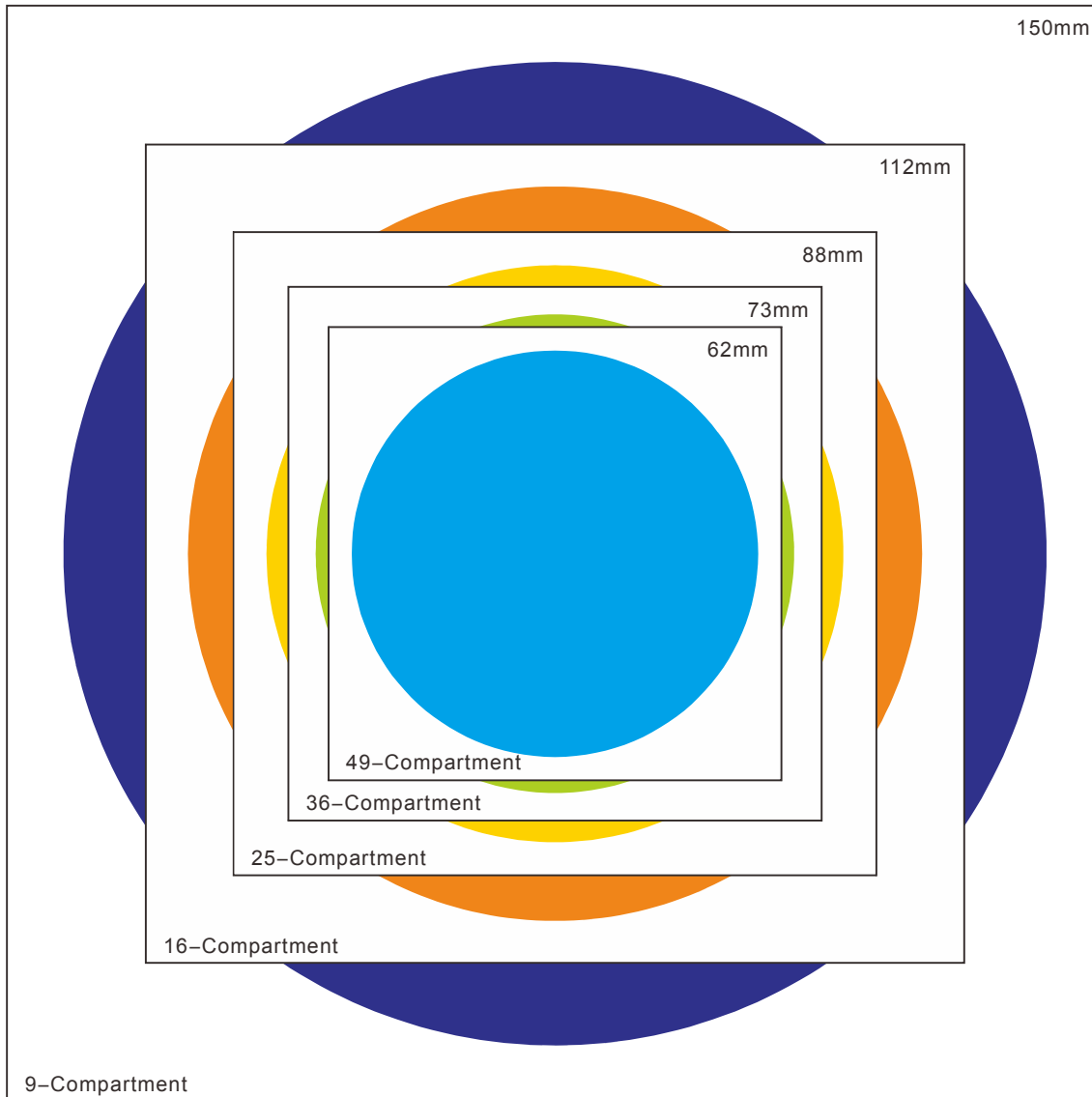

# Glass Racks

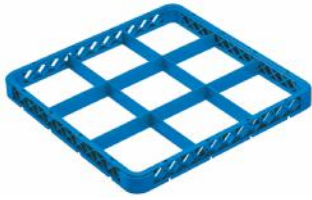

Art.No.	JW-92	JW-9	
<b>Name</b>	9-Compartment Standard Extender	9-Compartment Glass Rack	9-Compartment Glass Rack With 1 Extender
<b>Overall Size</b>	500x500x45 mm	500x500x100 mm	500x500x140 mm
<b>Comp.Size</b>	150x150x40 mm	150x150x82 mm	150x150x123 mm
<b>Colour</b>	Blue	Blue	Blue
<b>Material</b>	PP	PP	PP
<b>PCS/CTN</b>	12	6	6

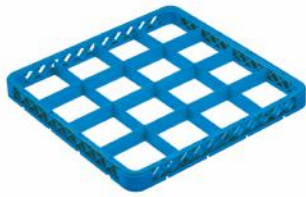

Art.No.	JW-162	JW-16	
<b>Name</b>	16-Compartment Standard Extender	16-Compartment Glass Rack	16-Compartment Glass Rack With 1 Extender
<b>Overall Size</b>	500x500x45 mm	500x500x100 mm	500x500x140 mm
<b>Comp.Size</b>	112x112x40 mm	112x112x82 mm	112x112x123 mm
<b>Colour</b>	Blue	Blue	Blue
<b>Material</b>	PP	PP	PP
<b>PCS/CTN</b>	6	6	6

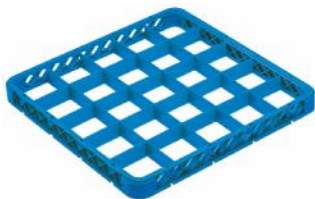

Art.No.	JW-252	JW-25	
<b>Name</b>	25-Compartment Standard Extender	25-Compartment Glass Rack	25-Compartment Glass Rack With 1 Extender
<b>Overall Size</b>	500x500x45 mm	500x500x100 mm	500x500x140 mm
<b>Comp.Size</b>	88x88x40 mm	88x88x82 mm	88x88x123 mm
<b>Colour</b>	Blue	Blue	Blue
<b>Material</b>	PP	PP	PP
<b>PCS/CTN</b>	6	6	6



# Glass Racks



Art.No.	JW-362	JW-36	
<b>Name</b>	36-Compartment Standard Extender	36-Compartment Glass Rack	36-Compartment Glass Rack With 1 Extender
<b>Overall Size</b>	500x500x45 mm	500x500x100 mm	500x500x140 mm
<b>Comp.Size</b>	73x73x40 mm	73x73x82 mm	73x73x123 mm
<b>Colour</b>	Blue	Blue	Blue
<b>Material</b>	PP	PP	PP
<b>PCS/CTN</b>	6	6	6



Art.No.	JW-492	JW-49	
<b>Name</b>	49-Compartment Standard Extender	49-Compartment Glass Rack	49-Compartment Glass Rack With 1 Extender
<b>Overall Size</b>	500x500x45 mm	500x500x100 mm	500x500x140 mm
<b>Comp.Size</b>	62x62x40 mm	62x62x82 mm	62x62x123 mm
<b>Colour</b>	Blue	Blue	Blue
<b>Material</b>	PP	PP	PP
<b>PCS/CTN</b>	6	6	6



Art.No.	JW-20	JW-S	JW-C	JW-64I
<b>Name</b>	20-Compartment Glass Rack	Open Rack	Cutlery Rack	64-Compartment Inset Rack
<b>Overall Size</b>	500x500x100 mm	500x500x100 mm	500x500x100 mm	470x470x74 mm
<b>Comp.Size</b>	112x88x82 mm	36x36mm	10x10mm	55x55x74mm
<b>Colour</b>	Blue	Blue	Blue	Blue
<b>Material</b>	PP	PP	PP	PP
<b>PCS/CTN</b>	6	6	6	6

# Glass Racks



Art.No.	JW-25B	JW-25P	JW-64B	JW-64P
<b>Name</b>	25-Compartment Plate & Tray Rack	25-Compartment Open Plate & Tray Rack	64-Compartment Plate & Tray Rack	64-Compartment Open Plate & Tray Rack
<b>Overall Size</b>	500x500x100 mm	500x500x100 mm	500x500x100 mm	500x500x100 mm
<b>Comp.Size</b>	65x65x66 mm	65x65x66 mm	45x45x72 mm	45x45x72 mm
<b>Colour</b>	Blue	Blue	Blue	Blue
<b>Material</b>	PP	PP	PP	PP
<b>PCS/CTN</b>	6	6	6	6



Art.No.	JW-1017	JW-102	JW-103	JW-172
<b>Name</b>	10/17-Compartment Glass Rack	10-Compartment Dropped Extender	10-Compartment Standard Extender	17-Compartment Dropped Extender
<b>Overall Size</b>	506x256x102 mm	502x252x125 mm	502x252x125 mm	502x252x125 mm
<b>Comp.Size</b>	27x27 mm	90x90x84 mm	90x90x41 mm	75x75x84 mm
<b>Colour</b>	Blue	Blue	Blue	Blue
<b>Material</b>	PP	PP	PP	PP
<b>PCS/CTN</b>	6	6	6	6



Art.No.	JW-173	JW-8B	JW-8BH
<b>Name</b>	17-Compartment Standard Extender	8-Compartment Cutlery Basket With Handle	8-Compartment Cutlery Basket Without Handle
<b>Overall Size</b>	502x252x125 mm	427x208x151 mm	427x208x151 mm
<b>Comp.Size</b>	75x75x84mm	90x90x110 mm	90x90x110 mm
<b>Colour</b>	Blue	Beige	Beige
<b>Material</b>	PP	PP	PP
<b>PCS/CTN</b>	6	12	12

# Glass Racks



Art.No.	JW-FCS	JW-FCC	JW-FCR	JW-FHR	JW-4C
<b>Name</b>	Sparse Bottom Square Knife & Fork Basket	Dense Bottom Square Knife & Fork Basket	Round Knife & Fork Basket	Square Knife & Fork Box	4-Scmpartment Cutlery Box
<b>Overall Size</b>	107x107x139 mm	107x107x139 mm	107x107x139 mm	295x170x125 mm	520x290x100 mm
<b>Comp.Size</b>	-	-	-	-	240x110x75 mm
<b>Colour</b>	White	White	White	Grey	Grey/Black
<b>Material</b>	PP	PP	PP	PP	PP
<b>PCS/CTN</b>	48	48	48	48	12



Art.No.	JW-GRC	JW-FRS	JW-P	JW-FRC
<b>Name</b>	Guide Cards	Floor Rack System	Open Extender	Glass Rack Cover
<b>Overall Size</b>	108x47x20 mm	335x335x38 mm	500x500x45 mm	505x505x26 mm
<b>Comp.Size</b>	108x47x20 mm	335x335x38 mm	500x500x45 mm	505x505x26 mm
<b>Colour</b>	Yellow/Green/Blue/White/Red	Grey	Blue	Blue
<b>Material</b>	PP	PP	PP	PP
<b>PCS/CTN</b>	504	12	16	36

## Glass & Cup Keepers

The largest inner diameter of the glass: 66mm  
 The largest inner diameter of the teacup: 74mm



Art.No.	JW-RT	JW-ST	JW-GK20	JW-CK12
<b>Name</b>	Rack Dolly Without Handle	Rack Dolly With Handle	Glass Keepers	Cup Keepers
<b>Overall Size</b>	540x540x185 mm	540x540x785 mm	455x355 mm	455x355 mm
<b>Comp.Size</b>	150KG	150KG	20 Glass	12 Cups
<b>Colour</b>	Blue	Blue	White	White
<b>Material</b>	PP	S/S,PP	ABS	ABS
<b>PCS/CTN</b>	1	1	24	24

# Storage Products



Efficient and convenient flip hinge lid that keeps food safe



Easy-To-Read Capacity Indicators



Features good fresh keeping.



# PC GN Pan

## PC GN Pan

- Features good fresh keeping.
- Durable construction makes no deforming, no hollowing and no cracking. Smooth interior makes clean up easy. withstands temperatures from -40°C to 99°C (-40°F -210°F )
- Colour: Clear, Black.

### Drain Shelves

- Available in sizes of 1/1, 1/2, 1/3, 1/4, 1/6 ; It supports contents and facilitates drainage.
- Colour: Clear, Black.



## Features



**Cover with handle**  
The lid has recessed handle, easy for a secure grip.



**Clear and Smooth Surface**  
Allows for a viewing of contents; Smooth interior makes clean up easy.



**Drain Shelves**  
Available in sizes of 1/1, 1/2, 1/3, 1/4, 1/6, supports contents and facilitates drainage.



**Capacity Marks**  
Sides are marked both in liters and in quarts capacities for easy inventory management.

# PP GN Pan

## PP GN Pan

- Hardly absorbs dust or causes fouling, keeping food clean and fresh.
- Made of environmental material polypropylene, inodorous, atoxic and easy clean-up.
- Withstands temperatures from  $-15^{\circ}\text{C}$  to  $80^{\circ}\text{C}$  ( $5^{\circ}\text{F}$  -  $176^{\circ}\text{F}$ ).
- Colour: Clear



## PC GN Tray

- GN trays are made of durable PC. That will not deform, and crack. Non-stick smooth exterior cleans up easily and quickly.
- Withstands temperatures form  $-40^{\circ}\text{C}$  to  $99^{\circ}\text{C}$
- Colour: Black.
- Material: PC



## GN Pan Lids



Name	Art.No	Size	PCS/CTN
Flat Lid	JW-P21FC	645x525x25 mm	12
	JW-P11FC	530x325 mm	12
	JW-P12FC	325x265 mm	12
	JW-P13FC	325x176 mm	24
	JW-P14FC	265x162 mm	24
	JW-P16FC	176x162 mm	48
	JW-P19HC	176x108 mm	48
Handle Lid	JW-P24HC	530x162 mm	24
	JW-P11HC	530x325 mm	12
	JW-P12HC	325x265 mm	12
	JW-P13HC	325x176 mm	24
	JW-P14HC	265x162 mm	24
Notch Lid	JW-P16HC	176x162 mm	48
	JW-P11HH	530x325 mm	12
	JW-P12HH	325x265 mm	12
	JW-P13HH	325x176 mm	24
	JW-P14HH	265x162 mm	24
Flip Lid	JW-P16HH	176x162 mm	48
	JW-P19HH	176x108 mm	48
	JW-P12FL	325x265 mm	12
Notched Flip Lid	JW-P13FL	325x176 mm	24
	JW-P16FL	176x162 mm	48
	JW-P12FLN	325x265 mm	12
Seal Lid	JW-P13FLN	325x176 mm	24
	JW-P16FLN	176x162 mm	48
	JW-P11SL	532x328 mm	12
	JW-P12SL	327x268 mm	12
Seal Lid	JW-P13SL	327x179 mm	24
	JW-P14SL	267x164 mm	24
	JW-P16SL	176x165 mm	48
	JW-P19SL	179x111 mm	48

# GN Pans (PP/PC)



GN2/1



GN1/1



GN1/2



GN1/3



GN1/4



GN1/6



GN1/9

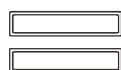

GN2/4



Specification	Art.No	Height & Name	Capacity	PCS/CTN
650x530mm	JW-P216	150mm	24L	6
	JW-P218	200mm	36L	6
530x325mm	JW-P112	65mm	8.5L	12
	JW-P114	100mm	13.0L	12
	JW-P116	150mm	19.5L	12
	JW-P118	200mm	25.6L	12
	JW-P11DS	Drain Shelf	460X250X19 mm	12
325x265 mm	JW-P122	65mm	3.9L	12
	JW-P124	100mm	5.9L	12
	JW-P126	150mm	8.9L	12
	JW-P128	200mm	11.7L	12
	JW-P12DS	Drain Shelf	156x196x15 mm	12
325x176 mm	JW-P132	65mm	2.4L	24
	JW-P134	100mm	3.6L	24
	JW-P136	150mm	5.3L	24
	JW-P138	200mm	6.9L	24
	JW-P13DS	Drain Shelf	250x100x18.5 mm	24
265x162 mm	JW-P142	65mm	1.7L	24
	JW-P144	100mm	2.5L	24
	JW-P146	150mm	3.7L	24
	JW-P14DS	Drain Shelf	210x108x15 mm	24
176x162 mm	JW-P162	65mm	1.0L	48
	JW-P164	100mm	1.5L	48
	JW-P166	150mm	2.2L	48
	JW-P16DS	Drain Shelf	123x108x15 mm	48
176x108 mm	JW-P192	65mm	0.57L	48
	JW-P194	100mm	0.85L	48
530x162 mm	JW-P242	65mm	5.58L	24
	JW-P244	100mm	8.58L	24
530x320 mm	JW-C2113	PC GN Tray(1/1, 1/2, 1/3, 1/4, 1/6, 1/9)		12
320x260 mm	JW-C1310	PC GN Tray(1/2, 1/3, 1/4, 1/6, 1/9)		24

# Square Storage Container



**Contents and Date Indicators on Lid**  
 Spare space of the lid can be marked with contents and date indicators, convenient to keep the quality and freshness of food.



**Textured Lid**  
 Made of polyethylene; Non-slip textured surface is resistant to scratches and it helps more stable stacking.



**Wide and Easy Handles**  
 Comfortable, wide and textured finish provides a secure grip. Drain holes in handles allow for quicker drying. Wide cove handles save effort when transported and do not waste space.



**Stackable lugs**  
 Corner stackable lugs add strength rigidity and prevent jamming when stacked.



**Date indicator**  
 Date indicators on all four sides for easy recognition.



**Textured Finish**  
 All corners, edges, handles and the bottom are designed with textured finish. It can reduce scratches, increase service time and provide safe use.

## PC Square Storage Container

Transparent polycarbonate allows for easy identification of products. Polycarbonate is extremely durable and stackable. Square shape allows for practical storage in the freezers and coolers. Withstands temperatures from  $-40^{\circ}\text{C}$  to  $99^{\circ}\text{C}$  ( $-40^{\circ}\text{F}$  -  $210^{\circ}\text{F}$ )  
 Colour: Clear.



## PP Square Storage Container







Made of polypropylene, economical and durable, It's a good choice for food storage. Dishwasher safe. Withstands temperatures from  $-5^{\circ}\text{C}$  to  $80^{\circ}\text{C}$  ( $5^{\circ}\text{F}$  -  $176^{\circ}\text{F}$ ).  
 Colour: Clear, White











# PP Square Storage Container



PC							
Art.No	P-060C	P-061C	P-062C	P-063C	P-064C	P-065C	P-066C
Name	2L Square Storage Container	4L Square Storage Container	6L Square Storage Container	8L Square Storage Container	12L Square Storage Container	18L Square Storage Container	22L Square Storage Container
Cover	P-080	P-080	P-081	P-081	P-082	P-082	P-082
Size	180x100 mm	180x190 mm	225x190 mm	225x230 mm	285x210 mm	285x320 mm	285x400 mm
Capacity	2L	4L	6L	8L	12L	18L	22L
Colour	Clear	Clear	Clear	Clear	Clear	Clear	Clear
PCS/CTN	60	48	24	24	12	12	6

PP							
Art.No	P-060P	P-061P	P-062P	P-063P	P-064P	P-065P	P-066P
Name	2L Square Storage Container	4L Square Storage Container	6L Square Storage Container	8L Square Storage Container	12L Square Storage Container	18L Square Storage Container	22L Square Storage Container
Cover	P-080	P-080	P-081	P-081	P-082	P-082	P-082
Size	180x100 mm	180x190 mm	225x190 mm	225x230 mm	285x210 mm	285x320 mm	285x400 mm
Capacity	2L	4L	6L	8L	12L	18L	22L
Colour	Clear/White	Clear/White	Clear/White	Clear/White	Clear/White	Clear/White	Clear/White
PCS/CTN	60	48	24	24	12	12	6



Art.No	P-080	P-081	P-082
Name	Lid	Lid	Lid
Size	187x17 mm	230x16 mm	290x15 mm
Colour	Green	Red	Blue
PCS/CTN	12	12	6

# PC Round Storage Container

- PC withstands temperatures from - 40°C to 99°C (-40°F –210°F ).
- With high impact resistance, fouling resistance and chemical resistance.
- Convenient outside graduations help easier inventory management.
- Snap-on cover can seal up the container and make no leakage.
- Colour: Clear.



Art.No	P-100C	P-101C	P-102C	P-103C
<b>Name</b>	1L Round Storage Container	2L Round Storage Container	3L Round Storage Container	6L Round Storage Container
<b>Cover</b>	P-090C	P-091C	P-091C	P-092C
<b>Size</b>	φ130x126 mm	φ188x108.5 mm	φ188x215 mm	φ226x199 mm
<b>Capacity</b>	1L	2L	4L	6L
<b>Colour</b>	Clear	Clear	Clear	Clear
<b>PCS/CTN</b>	48	24	12	12



Art.No	P-104C	P-105C	P-106C	P-107C
<b>Name</b>	7.5L Round Storage Container	10L Round Storage Container	15L Round Storage Container	20L Round Storage Container
<b>Cover</b>	P-092C	P-093C	P-093C	P-093C
<b>Size</b>	φ226x274mm	φ315x214 mm	φ315x304 mm	φ315x378 mm
<b>Capacity</b>	7.5L	10L	15L	20L
<b>Colour</b>	Clear	Clear	Clear	Clear
<b>PCS/CTN</b>	12	12	6	6



Art.No	P-090C	P-091C	P-092C	P-093C
<b>Name</b>	Lid	Lid	Lid	Lid
<b>Size</b>	φ135.5x10.1 mm	φ192x12 mm	φ232x12.1 mm	φ320x15mm
<b>Colour</b>	Clear	Clear	Clear	Clear
<b>PCS/CTN</b>	12	12	12	12

# PP Round Storage Container

- PP withstands temperatures from -15°C to 80°C.
- With high impact resistance, fouling resistance and chemical resistance.
- Convenient outside graduations help easier inventory management.
- Snap-on cover can seal up the container and make no leakage.
- Colour: Clear,White.



Art.No	P-100P	P-101P	P-102P	P-103P
<b>Name</b>	1L Round Storage Container	2L Round Storage Container	4L Round Storage Container	6L Round Storage Container
<b>Cover</b>	P-090P	P-091P	P-091P	P-092P
<b>Size</b>	φ130x126 mm	φ188x108.5 mm	φ188x215 mm	φ226x199 mm
<b>Capacity</b>	1L	2L	4L	6L
<b>Colour</b>	Clear/White	Clear/White	Clear/White	Clear/White
<b>PCS/CTN</b>	48	24	12	12



Art.No	P-104P	P-105P	P-106P	P-107P
<b>Name</b>	7.5L Round Storage Container	10L Round Storage Container	15L Round Storage Container	20L Round Storage Container
<b>Cover</b>	P-092P	P-093P	P-093P	P-093P
<b>Size</b>	φ226x274mm	φ315x214 mm	φ315x304 mm	φ315x378 mm
<b>Capacity</b>	7.5L	10L	15L	20L
<b>Colour</b>	Clear/White	Clear/White	Clear/White	Clear/White
<b>PCS/CTN</b>	12	12	6	6



Art.No	P-090P	P-091P	P-092P	P-093P
<b>Name</b>	Lid	Lid	Lid	Lid
<b>Size</b>	φ135.5x10.1 mm	φ192x12 mm	φ232x12.1 mm	φ320x15mm
<b>Colour</b>	Clear/White	Clear/White	Clear/White	Clear/White
<b>PCS/CTN</b>	12	12	12	12

# PC Food Storage Box

- Clear polycarbonate is a break-resistant material.  
Allows for easy recognition of inside products.
- Can be used in freezer or refrigerator.
- Withstands temperatures from - 40°C to 99°C (-40°F -210°F ).



Art.No.	P-072C	P-067C	P-068C	P-073C
<b>Name</b>	6.6L Food Storage Box	11.4L Food Storage Box	18L Food Storage Box	19L Food Storage Box
<b>Cover</b>	P-083C	P-083C	P-083C	P-084C
<b>Drain Shelf</b>	P06DS	P06DS	P06DS	P07DS
<b>Size</b>	460x300x90 mm	460x300x150 mm	460x300x230 mm	662x460x90 mm
<b>Material</b>	6.6L	11.4L	18L	19L
<b>Colour</b>	Clear	Clear	Clear	Clear
<b>PCS/CTN</b>	12	12	12	6



Art.No.	P-069C	P-070C	P-071C	P-074C
<b>Name</b>	33L Food Storage Box	49.2L Food Storage Box	64L Food Storage Box	83.3L Food Storage Box
<b>Cover</b>	P-084C	P-084C	P-084C	P-084C
<b>Drain Shelf</b>	P07DS	P07DS	P07DS	P07DS
<b>Size</b>	662x460x150 mm	662x460x240 mm	662x460x315 mm	662x460x385 mm
<b>Material</b>	33L	49.2L	64L	83.3L
<b>Colour</b>	Clear	Clear	Clear	Clear
<b>PCS/CTN</b>	6	6	6	6



Art.No.	P-083C	P-084C	P06DS	P07DS
<b>Name</b>	Small Lid For Food Storage Box	Big Lid For Food Storage Box	Small Drain Shelf For Food Storage Box	Big Drain Shelf For Food Storage Box
<b>Size</b>	460x300x30 mm	662x460x31.5 mm	355x205x15 mm	555x335x16 mm
<b>Colour</b>	Clear	Clear	Clear	Clear
<b>PCS/CTN</b>	12	12	24	24

# PP Food Storage Box

- With capabilities of anti-impact, anti-fouling and anti-chemical corrosion.
- It is a more economical choice than PC.
- Withstands temperatures from -15°C to 80°C (5°F -176°F ).



Art.No.	P-072P	P-067P	P-068P	P-073P
<b>Name</b>	6.6L Food Storage Box	11.4L Food Storage Box	18L Food Storage Box	19L Food Storage Box
<b>Cover</b>	P-083P	P-083P	P-083P	P-084P
<b>Drain Shelf</b>	P06DSP	P06DSP	P06DSP	P07DSP
<b>Size</b>	460x300x90 mm	460x300x150 mm	460x300x230 mm	662x460x90 mm
<b>Material</b>	6.6L	11.4L	18L	19L
<b>Colour</b>	White	White	White	White
<b>PCS/CTN</b>	12	12	12	6



Art.No.	P-069P	P-070P	P-071P	P-074P
<b>Name</b>	33L Food Storage Box	49.2L Food Storage Box	64L Food Storage Box	83.3L Food Storage Box
<b>Cover</b>	P-084P	P-084P	P-084P	P-084P
<b>Drain Shelf</b>	P07DSP	P07DSP	P07DSP	P07DSP
<b>Size</b>	662x460x150 mm	662x460x240 mm	662x460x315 mm	662x460x385 mm
<b>Material</b>	33L	49.2L	64L	83.3L
<b>Colour</b>	White	White	White	White
<b>PCS/CTN</b>	6	6	6	6



Art.No.	P-083P	P-084P	P06DSP	P07DSP
<b>Name</b>	Small Lid For Food Storage Box	Big Lid For Food Storage Box	Small Drain Shelf For Food Storage Box	Big Drain Shelf For Food Storage Box
<b>Size</b>	460x300x30 mm	662x460x31.5 mm	355x205x15 mm	555x335x16 mm
<b>Colour</b>	White	White	White	White
<b>PCS/CTN</b>	12	12	24	24

# Food Storage Series

## Food Storage Pan Sliding Lid

- The cover can be slided to the back to take out the ingredients.
- Can keep food fresh.
- Can prevent bacteria and cross contamination.
- Can identify the food materials easily.

The lid can be slided forward backward and also can be lifted, which makes the easily.



Art.No.	P-085	P-086
Name	Small Food Storage Pan Sliding Lid	Large Food Storage Pan Sliding Lid
Size	450x300x31 mm	650x450x33 mm
Box	P-072C,P-067C,P-068C	P-073,P-069C,P-070C,P-071C,P-074C
Colour	White+Clear	White+Clear
PCS/CTN	12	12

## Food Preparation Pan

- Ideal for storing and transporting food.
- It is durable and won't crack or bend.
- Material:PC



Art.No.	JW-MTP50	JW-MTP55	JW-MTP60	JW-MTP65	JW-MTP80
Name	1.7L Food Preparation Pan	2.5L Food Preparation Pan	4.4L Food Preparation Pan	6.0L Food Preparation Pan	9.6L Food Preparation Pan
Size	270x210x50 mm	305x240x55 mm	360x280x60 mm	420x296x65 mm	480x335x80 mm
Capacity	1.7L	2.5L	4.4L	6.0L	9.6L
Colour	Clear	Clear	Clear	Clear	Clear
PCS/CTN	36	24	24	24	24

Note: This item requires a MOQ.

## Beverage dispenser

- Perfect for mixing and serving concentrated beverages.
- Impact-resistant polypropylene can withstand temperature from -40°C to 70°C (-40° F-160° F),
- Colour:White

Art.No.	JW-BD20
Name	Beverage Dispenser
Size	Φ315x348 mm
Capacity	20L
PCS/CTN	4



# Ingredient Bins/Shelf Ingredient Bins

## Ingredient Bins



- Siamese cover design makes it easy to scoop raw materials up with one hand, improving work efficiency.
- Insert rail for the scoop makes it easy to take out the scoop and makes direct touch with the materials.
- Drawer-type cover makes one-hand scooping easy and improves work efficiency.
- Clear front cover helps quick identification of inside ingredients and better inventory management.
- Smooth interior and exterior makes clean-up easily.
- It can be easily moved with 3" castors.
- Ideal for storing dry bulk goods such as sugar, flour, rice and other cereals.

### Spare parts specification

Scoop's pothook makes it easy to take it out from the bin, saving time.  
Scoop handle remains out from the ingredient bin, preventing contamination.  
Special scoop.



Art.No.	JW-S81	JW-S102	JW-S120
Name	81L Ingredient Bins	102L Ingredient Bins	120L Ingredient Bins
Size	745x328x740 mm	750x410x745 mm	750x457x748 mm
Capacity	81L	102L	120L
Weight Capacity (Sugar )	72.7KG	89.4KG	106KG
Weight Capacity (Flour )	56.3KG	69.9KG	83.5KG
Weight Capacity (Rice )	81KG	102KG	120KG
PCS/CTN	1	1	1

## Shelf Ingredient Bins



- New and improved bins designed to store small amounts of food and ingredients.
- Patented cover; easy to take out the ingredients with one hand even when the bins are stacked.
- Clear cover for quick and easy identification of ingredients and better inventory management.
- Ideal for storing small amounts of ingredients.
- Material: PC, PP.
- Colour: White.



Art.No.	JW-S8	JW-S20	JW-S40
Name	8L Shelf Ingredient Bins	20L Shelf Ingredient Bins	40L Shelf Ingredient Bins
Size	367x296x220 mm	593x290x432 mm	593x486x432 mm
Capacity	8L	20L	40L
PCS/CTN	1	1	1

# Dough Storage Box



- Suitable for storing and transporting dough,
- Light, durable and break-resistant,
- Chemical-resistant and easy to be cleaned, does not absorb odor.
- Can be stacked tightly, and keep dust and contamination away. prolonging food freshness,
- Stacking reduces the demand of lids, and save cost,
- Withstands temperature from -40°C-70°C ( -40°F-160°F ) ,
- The lid can be used separately as a tray.



Box body can be stacked closely to isolate contaminants.



Humanized design of waving handles.



Installing universal wheels help easier transport.



Art.No.	JW-DB18266	JW-DB18263	JW-DBC1826	JW-SSD1826
<b>Name</b>	Big Dough Storage Box	Small Dough Storage Box	Dough Storage Box Lid	Dolly
<b>Size</b>	655x455x163 mm	655x455x86 mm	655x455x45 mm	690x460x197 mm
<b>Colour</b>	White	White	White	Silver
<b>Material</b>	PP	PP	PP	Chrome
<b>Product Weight</b>	2.2KG	1.5KG	1.2KG	2.9KG
<b>PCS/CTN</b>	1	1	1	1



# Ingredient Container

- Rotating lid allows for one-handed operation.
- Clear lid for fast ingredient identification
- Safe and efficient food storage
- Different sizes are available: 10gal/20gal/32gal
- Easy to be transported with JIWIN'S dollies(20gal/32gal).
- 20oz Big clear scoop allows for convenient access of ingredients.



P-046



Art.No.	JW-CRCS38	JW-CRCS76	JW-CRCS120	P-046
<b>Name</b>	Sliding Lid For 10 Gal Container	Sliding Lid For 20 Gal Container	Sliding Lid For 32 Gal Container	20oz Big Clear Scoop
<b>Material</b>	PP+PC	PP+PC	PP+PC	PC
<b>Fit Container Art.No.</b>	JW-CR38W	JW-CR76W	JW-CR120W	Together With Lid
<b>Size</b>	Φ437x76 mm	Φ533x82 mm	Φ599x85 mm	140x104x250 mm
<b>Packaging size</b>	450x450x360 mm	545x545x400 mm	620x620x400 mm	335x140x125 mm
<b>PCS/CTN</b>	6	6	6	6



Art.No.	JW-CRC1P(WHITE)	JW-CRC2P(WHITE)	JW-CRC3P(WHITE)
<b>Name</b>	Round Lid For 10 Gal Container	Round Lid For 20 Gal Container	Round Lid For 32 Gal Container
<b>Material</b>	PP	PP	PP
<b>Fit Container Art.No.</b>	JW-CR38W	JW-CR76W	JW-CR120W
<b>Size</b>	Φ410x28 mm	Φ510x40 mm	Φ570x38 mm
<b>Packaging size</b>	465x423x605 mm	565x520x425 mm	575x575x430 mm
<b>PCS/CTN</b>	24	12	12



Art.No.	JW-CR38W	JW-CR76W	JW-CR120W
<b>Name</b>	10 Gal Ingredient Container	20 Gal Ingredient Container	32 Gal Ingredient Container
<b>Size</b>	Φ398x434 mm	Φ492x584 mm	Φ557x693 mm
<b>Colour</b>	White	White	White
<b>Material</b>	PP	PP	PP
<b>Packaging size</b>	420x420x930 mm	510x510x126 mm	580x580x147 mm
<b>PCS/CTN</b>	6	6	6

## Dolly for Recycle Round container

- 5 swivel casters offer better mobility in the working area.
- Snap-in construction makes it more stable.

Bearing: 250 KG  
Colour: Black



JW-RCD



## Salad Spinner

- Patent design, innovative brakes effectively improve the service life of gear.
- Sealed rotating system to ensure food safety.
- Meets hygiene standards of FDA.
- Confidence and control to ensure salad ingredients will be clean and fresh, clockwise and counter-clockwise rotation, allowing you to easily dry your products in a flash.
- Suitable for kitchens in restaurants and hotels.



2.5 Gal

5 Gal

Art.No.	JW-SP9.5	JW-SP19
Name	Big Salad Spinner	Big Salad Spinner
Size	Φ395x470 mm	Φ465x565 mm
Capacity	9.5L/2.5Gal	19L/5Gal
Colour	Green	Green
Weight	3.3 kg	4.3 kg
PCS/CTN	1	1

# Versa Organizer

- Used for storing condiments, cutlery, straws, napkins or other small items
- Memo or note can be placed on the label area for easy distinguishing
- Holding bins can be combined into 2x3, 2x4, 3x3, or 3x4 dimensions
- Boxes can be stacked, which saves a lot of space.
- The organizer can be placed on flat or can be wall-mount installed.
- The maximum bearing capacity is 54KGS if it is wall-mounted.
- Bearing capacity for each box: 4.5 KGS
- Material: Polypropylene, aluminum alloy



JW-VOB



JW-VO23



JW-VO24



JW-VO33



JW-VO34

Art.No.	JW-VOB	JW-VO23	JW-VO24	JW-VO33	JW-VO34
<b>Name</b>	Organizers Box	2x3 Organizers box	2x4 Organizers box	3x3 Organizers box	3x4 Organizers box
<b>Size</b>	293x127x109 mm	440x310x300 mm	568x310x300 mm	440x310x475 mm	568x310x475 mm
<b>Colour</b>	Spot dust	Spot dust	Spot dust	Spot dust	Spot dust
<b>Material</b>	PP	PP+Aluminium alloy	PP+Aluminium alloy	PP+Aluminium alloy	PP+Aluminium alloy
<b>Weight</b>	0.32 KG	3 KG	3.8 KG	4.4 KG	5.6 KG
<b>PCS/CTN</b>	/	12	9	8	6

# Tabletop Service Products



# Beverage Tumblers

## Stackable Round Base Tumblers

- Made of break-resistant polycarbonate or durable SAN, it's environment-friendly and sanitary.
- Stacking lugs prevent jamming when stored.
- The interior is easy to be cleaned.
- Widely used for drinks like water, ice tea, sodas or other drinks.

Material:PC/AS  
Colour:Clear



PC Art.No. AS Art.No.	JW-1006C JW-1006A	JW-1008C JW-1008A	JW-1009C JW-1009A	JW-1010C JW-1010A	JW-1012C JW-1012A	JW-1014C JW-1014A	JW-1016C JW-1016A	JW-1020C JW-1020A
Top Dia(cm)	6.4	6.8	8.3	7.1	7.6	7.9	8.3	8.7
Bottom Dia(cm)	4.8	4.9	6	5.4	5.6	6	5.9	6.5
Height(cm)	9.4	10.2	8.4	11.6	13	12.7	14.6	16.5
Capacity(ml/oz)	189/6	228/7.3	275/8.8	300/9.65	373/12	414/13.3	485/15.6	650/21
PCS/CTN	72	72	72	72	72	72	72	72

## Popular Polycarbonate Tumblers

- Made of break-resistant polycarbonate or durable SAN, it's environment-friendly and sanitary.
- The surface does not wear down easily.
- With attractive design; smooth interior makes clean up easily.
- Ideal for bars, hotels or banquets

Material:PC/AS  
Colour:Clear



PC Art.No. AS Art.No.	JW-2005C JW-2005A	JW-2008C JW-2008A	JW-2010C JW-2010A	JW-2120C JW-2120A	JW-2012C JW-2012A	JW-2014C JW-2014A	JW-2016C JW-2016A	JW-2022C JW-2022A
Top Dia(cm)	6	6.8	7.1	7.6	8.6	8.3	8.4	8.9
Bottom Dia(cm)	4.6	4.9	5.5	5.8	7.3	6.4	6.4	6.7
Height(cm)	9	11.3	12.2	12.8	9.5	12.4	14	17
Capacity(ml/oz)	182/5.8	284/9.1	307/9.9	355/11.4	355/11.4	410/13.2	480/15.4	695/22.3
PCS/CTN	72	72	72	72	72	72	72	72

## Watermark Round Base Tumblers

- Attractive pebbled exterior hides scratches and the tumbler is easy to be held.
- Made of environmental material, safe and sanitary.

Material:PC/AS  
Colour:Clear



PC Art.No. AS Art.No.	JW-4005C JW-4005A	JW-4008C JW-4008A	JW-4009C JW-4009A	JW-4010C JW-4010A	JW-4011C JW-4011A	JW-4012C JW-4012A	JW-4015C JW-4015A
Top Dia(cm)	5.4	6.2	6.4	6.5	7	7	7.5
Bottom Dia(cm)	4.8	5.6	5.9	5.8	6.4	6.4	6.7
Height(cm)	9.5	11.1	11.8	11.5	12.3	12.9	14
Capacity(ml/oz)	158/5.1	248/8.0	280/9.0	289/9.3	358/11.5	373/12	466/15
PCS/CTN	72	72	72	72	72	72	72

# Beverage Tumblers

## Classic Leopard Grain Tumblers

- Attractive panel and facet design
- Made of break-resistant polycarbonate or durable SAN, safe and sanitary
- Ideal for outdoor recreation places, clubs or homes

Material:PC/AS  
Colour:Clear



PC Art.No. AS Art.No.	JW-3008C JW-3008A	JW-3010C JW-3010A	JW-3012C JW-3012A	JW-3014C JW-3014A	JW-3015C JW-3015A	JW-3022C JW-3022A
Top Dia(cm)	6.9	7.4	7.9	8.3	8.4	9.3
Bottom Dia(cm)	5.3	5.4	5.6	5.9	6.3	6.9
Height(cm)	10.9	12.1	12.7	13.1	14	15.4
Capacity(ml/oz)	240/7.7	198/9.65	368/11.8	420/13.5	452/14.6	655/21.1
PCS/CTN	72	72	72	72	72	72

## Juice Tumblers

- Made of break-resistant polycarbonate or durable SAN material, easy to clean and store

Material:PC/AS  
Colour:Clear



PC Art.No. AS Art.No.	JW-1220C JW-1220A	JW-1216C JW-1216A
Top Dia(cm)	8.8	9
Bottom Dia(cm)	6.2	6.8
Height(cm)	16	13
Capacity(ml/oz)	530/17	485/15.6
PCS/CTN	72	72

## Propitious Flat Base Tumblers

- Bright color follows up with people's color references
- Frosted surface avoids to be scraped
- Stacking lugs prevent jamming when stored
- Ideal for homes, schools and chain restaurants

Material:PC/AS  
Colour:Translucent Blue  
Translucent Orange



Art.No.	JW-8010P	JW-8013P	JW-8016P
Top Dia(cm)	6.8	7.5	7.9
Bottom Dia(cm)	5.5	6.2	6.3
Height(cm)	11.2	12	13.8
Capacity(ml/oz)	280/9	390/12.6	480/15.5
PCS/CTN	72	72	72

## Pleasant Wide-mouth Tumblers

- Bright color follows up with people's color references
- Frosted surface avoids to be scraped
- Stacking lugs prevent jamming when stored
- Ideal for homes, schools and chain restaurants

Material:PC/AS  
Colour:Translucent Blue /  
Translucent Orange



Art.No.	JW-1110P	JW-1113P
Top Dia(cm)	8.1	8.7
Bottom Dia(cm)	5.5	5.6
Height(cm)	9.4	11.7
Capacity(ml/oz)	290/9.3	405/13
PCS/CTN	72	72

# Beverage Tumblers

## Beverage Tumblers

- Made of durable polycarbonate or SAN material.
- Environment-friendly, break-resistant, sanitary and long lasting.
- Stacking lugs prevent jamming when stored.
- Ideal for schools, hospitals and chain restaurants.

Material:PC/AS  
Colour:Clear



PC Art.No. AS Art.No.	JW-5050C JW-5050A	JW-5080C JW-5080A	JW-5085C JW-5085A	JW-5095C JW-5095A	JW-5120C JW-5120A	JW-5160C JW-5160A
Top Dia(cm)	5.7	6.7	8.6	7	7.5	7.9
Bottom Dia(cm)	4.4	5.1	5.4	5.4	5.7	6
Height(cm)	9.2	10.2	9.7	11.1	13.2	14.7
Capacity(ml/oz)	154/5	230/7.4	320/10.3	275/8.9	455/14.6	460/14.9
PCS/CTN	72	72	72	72	72	72

## Concave Base Tumblers

- Made of durable polycarbonate or impact resistant SAN for lower cost.
- Textured body prevents scratches.
- Ideal for bar, poolside and tabletop service.

Material:PC/AS  
Colour:Clear



PC Art.No. AS Art.No.	JW-6050C JW-6050A	JW-6080C JW-6080A	JW-6090C JW-6090A	JW-6095C JW-6095A	JW-6120C JW-6120A	JW-6160C JW-6160A	JW-6210C JW-6210A	JW-6310C JW-6310A
Top Dia(cm)	5.7	6.7	8.1	7	7.5	7.9	8.6	10
Bottom Dia(cm)	4.4	5.1	6.35	5.4	5.7	6	6.35	7.3
Height(cm)	9.2	10.2	8.3	11.1	13.2	14.6	16.5	18.2
Capacity(ml/oz)	154/5	231/7.4	287/9.2	290/9.3	373/12	485/15.6	650/20.9	976/31.4
PCS/CTN	72	72	72	72	72	72	72	72

## Textured Drinking Tumblers

- Made of transparent polycarbonate or impact resistant SAN, it is lightweight and sanitary.
- Textured body prevents scratches.
- Ideal for restaurants, schools or homes.

Material:PC/AS  
Colour:Clear



PC Art.No. AS Art.No.	JW-7009C JW-7009A	JW-7011C JW-7011A	JW-7015C JW-7015A	JW-7016C JW-7016A	JW-7024C JW-7024A
Top Dia(cm)	6.7	7.5	9.7	7.8	8.8
Bottom Dia(cm)	5.1	6	8.3	6	7.2
Height(cm)	10.6	10.6	8.3	15.1	16.8
Capacity(ml/oz)	265/8.5	331/10.7	463/14.9	498/160	743/23.9
PCS/CTN	72	72	72	72	72



# Beverage Tumblers

## Textured Flat Base Tumblers

- Made of unbreakable polycarbonate or impact resistant SAN.
- Elegant design and textured body feature the tumbler a good deal of drink service.

Material:PC/AS  
Colour:Clear



JW-9010C JW-9011C JW-9012C JW-9013C  
JW-9010A JW-9011A JW-9012A JW-9013A

## Square Base Drinking Tumblers

- Made of super-clear polycarbonate or impact resistant SAN for a sanitary drinking and the lightweight construction is easy to carry.
- The thick base adds the stability.
- Ideal for drinking service.

Material:PC/AS  
Colour:Clear



JW-1308C JW-1310C JW-1311C JW-1312C JW-1314C  
JW-1308A JW-1310A JW-1311A JW-1312A JW-1314A

## Round Base Drinking Tumblers

- Made of super-clear polycarbonate or impact resistant SAN for sanitary drinking and lightweight construction
- A low cost of replacement is ensured as well.
- Ideal for drinking service.

Material:PC/AS  
Colour:Clear



JW-1611C JW-1613C JW-1615C JW-1616C JW-1618C  
JW-1611A JW-1613A JW-1615A JW-1616A JW-1618A

## Thick Base Tumblers

- Made of unbreakable polycarbonate or impact resistant SAN for a safe drinking
- The product is designed with a thick base, providing a good stability.
- Ideal for restaurant service, bar service or poolside service.

Material:PC/AS  
Colour:Clear



JW-1512C JW-1513C JW-1514C JW-1515C JW-1518C  
JW-1512A JW-1513A JW-1514A JW-1515A JW-1518A

## Textured Flat Base Tumblers

PC Art.No. AS Art.No.	JW-9010C JW-9010A	JW-9011C JW-9011A	JW-9012C JW-9012A	JW-9013C JW-9013A
Top Dia(cm)	8.1	8.5	8	8.1
Bottom Dia(cm)	5.7	5.7	5.1	5.8
Height(cm)	12.0	11.4	12.8	13.7
Capacity(ml/oz)	290/10.5	370/11.9	380/12.2	410/13.2
PCS/CTN	72	72	72	72

## Square Base Drinking Tumblers

PC Art.No. AS Art.No.	JW-1308C JW-1308A	JW-1310C JW-1310A	JW-1311C JW-1311A	JW-1312C JW-1312A	JW-1314C JW-1314A
Top Dia(cm)	6.5	8.3	7.6	7.2	8.5
Bottom Dia(cm)	4.2	5.1	4.9	4.8	6.6
Height(cm)	12	9.5	14	14.5	12
Capacity(ml/oz)	224/7.2	358/11.5	363/11.7	372/12	425/13.7
PCS/CTN	72	72	72	72	72

## Round Base Drinking Tumblers

PC Art.No. AS Art.No.	JW-1611C JW-1611A	JW-1613C JW-1613A	JW-1615C JW-1615A	JW-1616C JW-1616A	JW-1618C JW-1618A
Top Dia(cm)	8	7.4	7.4	8.2	8.8
Bottom Dia(cm)	5.4	5.7	6.8	5.5	5.7
Height(cm)	13.5	13.7	13.8	15	15.4
Capacity(ml/oz)	350/11.3	420/13.5	465/15	490/15.8	565/18.2
PCS/CTN	72	72	72	72	72

## Thick Base Tumblers

PC Art.No. AS Art.No.	JW-1512C JW-1512A	JW-1513C JW-1513A	JW-1514C JW-1514A	JW-1515C JW-1515A	JW-1518C JW-1518A
Top Dia(cm)	8.2	8	7.3	8.2	8.1
Bottom Dia(cm)	5.3	6	6.2	6.1	6
Height(cm)	15.2	16.9	18.2	18	16
Capacity(ml/oz)	488/16	410/13.2	435/14	480/15.4	560/18
PCS/CTN	72	72	72	72	72



# Beverage Tumblers

## Mark Beer Tumblers

- Made of unbreakable polycarbonate or impact resistant SAN.
- A wide and easy-grip handle ensures a quick drying and applies to dishwasher.
- Ideal for serving beer, tea or soda on table service.

Material:PC  
Colour:Clear



Art.No.	JW-1815C	JW-1820C	JW-1821C	JW-1812C	JW-1813C
Top Dia(cm)	8.6	9.5	9.5	7.3	8.9
Bottom Dia(cm)	7.9	6.8	7.5	6.6	5.5
Height(cm)	11.2	12	12.7	13	14.3
Capacity(ml/oz)	455/14.6	605/19.5	630/20.3	365/11.7	410/13.2
Max Lenght	11.2	13.5	13	10.5	11.7
PCS/CTN	72	72	72	72	72

## Thick Base Beer Tumblers

- Made of unbreakable polycarbonate or impact resistant SAN.
- Elegant design and lightweight construction allows for an easy handle.
- Ideal for bars, hotels and clubs.

Material:PC/AS  
Colour:Clear



PC Art.No. AS Art.No.	JW-1708C JW-1708A	JW-1710C JW-1710A	JW-1711C JW-1711A	JW-1712C JW-1712A	JW-1713C JW-1713A	JW-1714C JW-1714A
Top Dia(cm)	7.2	7.9	7.7	7.9	8.4	7
Bottom Dia(cm)	5.7	5.8	6	6	7.2	5.9
Height(cm)	12.6	18	13.8	12.6	13	16.5
Capacity(ml/oz)	250/8	310/10	340/10.9	360/11.6	390/12.5	340/10.9
PCS/CTN	72	72	72	72	72	72

## Polygon Base Tumblers

- Unbreakable polycarbonate or impact resistant SAN ensures a sanitary drinking and a low replacement cost.
- A wide mouth provides an easy washing.
- Ideal for drinking service.



Material:PC/AS  
Colour:Clear

PC Art.No. AS Art.No.	JW-1411C JW-1411A
Top Dia(cm)	7.4
Bottom Dia(cm)	5.9
Height(cm)	12.1
Capacity(ml/oz)	355/11.4
PCS/CTN	72

## V-Base Beer Tumblers

- Made of super-clear polycarbonate or impact resistant SAN.
- Designed with a tapered body, allowing easy pouring.
- Suit for beverage with alcohol less than 75%.



Material:PC/AS  
Colour:Clear

PC Art.No. AS Art.No.	JW-2313C JW-2313A
Top Dia(cm)	8
Bottom Dia(cm)	7.7
Height(cm)	19
Capacity(ml/oz)	420/13.5
PCS/CTN	72

# Beverage Tumblers

## Stem Tumblers

- Made of super-clear, anti-breakage polycarbonate.
- A durable tumbler for bar service, room service or poolside service.

Material:PC  
Colour:Clear



Art.No.	JW-2103C	JW-2105C	JW-2111C	JW-2115C
Top Dia(cm)	5.2	6.8	7.9	8.9
Bottom Dia(cm)	6.6	6.6	7.7	8.2
Height(cm)	18.8	13.5	18.3	17.8
Capacity(ml/oz)	156/5	175/5.6	340/11	480/15.4
PCS/CTN	72	72	72	72

## Ice cream Tumblers

- Made of super-clear and durable polycarbonate.
- An excellent choice for poolside and other outdoor events that requires break resistance.

Material:PC  
Colour:Clear



Art.No.	JW-2205C	JW-2206C	JW-2207C
Top Dia(cm)	10	9.9	10
Bottom Dia(cm)	6.8	6.7	6.8
Height(cm)	9.3	9	13.8
Capacity(ml/oz)	170/5.5	215/6.9	220/7.1
PCS/CTN	72	72	72

# Fast Food Tray

## Fast Food Tray

- Made of high strength ABS or heat resistant polypropylene.
- With unique non-slip design, it can minimize the food wasting.
- Ideal for schools, restaurants and fast-food chains.
- It is not suggested to use in heating insulated cart.

Material: PP/ABS

Colour: Coffee/Red/Black

JW-A1014



JW-A1218

JW-A1216



JW-B1115

JW-E1218



JW-D1217



JW-A1418

PP Art.No.	JW-A1014P	JW-A1216P	JW-A1218P	JW-A1418P	JW-B1115P	JW-D1217P	JW-E1218P
ABS Art.No.	JW-A1014A	JW-A1216A	JW-A1218A	JW-A1418A	JW-B1115A	JW-D1217A	JW-E1218A
<b>Overall size</b>	345x263 mm	415x300 mm	455x300 mm	455x355 mm	380x280 mm	425x300 mm	450x305 mm
<b>Height</b>	20 mm	20 mm	20 mm	18.5 mm	21 mm	32 mm	27 mm
<b>Capacity</b>	320x230 mm	380x270 mm	400x270 mm	420x320 mm	340x240 mm	360x280 mm	420x270 mm
<b>Material</b>	PP/ABS	PP/ABS	PP/ABS	PP/ABS	PP/ABS	PP/ABS	PP/ABS
<b>PCS/CTN</b>	24	24	24	24	24	24	24

# Fast Food Tray

## PP Non-slip Tray Series

- Made of heat resistant polypropylene.
- Rubber surface can prevent tableware from slipping.
- Lightweight construction and shatterproof textures minimize the labor for service and replacement cost.
- Suitable for restaurant, bar, nightclub and coffee shop.

Material: PP

Colour: Brown/Black



Art.No.	JW-R1100P	JW-R1400P	JW-R1600P
Name	Round Anti-Skid Tray	Round Anti-Skid Tray	Round Anti-Skid Tray
Size	Φ280x20 mm	Φ355x22 mm	Φ405x22 mm
PCS/CTN	12	12	12



Art.No.	JW-R1014P	JW-R1216P	JW-R1418P	JW-R1520P	JW-R1622P
Name	Rectangle Anti-Skid Tray	Rectangle Anti-Skid Tray	Rectangle Anti-Skid Tray	Rectangle Anti-Skid Tray	Rectangle Anti-Skid Tray
Size	354x255x22.5 mm	409x299x20 mm	457x355x22 mm	507x380x22 mm	558x405x22 mm
PCS/CTN	12	12	12	12	12

## Fiberglass Non-slip Tray Series

- Made of durable fiberglass.
- Glass fiber layer and the rubber layer solidified into a whole.
- High impact resistance and anti-deformation.  
Resistant to 120°C(248°F )

Material: Fiberglass

Colour: Brown/Black



Art.No.	JW-R1100CT	JW-R1400CT	JW-R1600CT	JW-R1800CT	JW-R1014CT
Name	Round Anti-Skid Tray	Round Anti-Skid Tray	Round Anti-Skid Tray	Round Anti-Skid Tray	Rectangle Anti-Skid Tray
Size	Φ280x20 mm	Φ355x22.5 mm	Φ405x22 mm	Φ460x22 mm	350x270 mm
PCS/CTN	12	12	12	12	12



Art.No.	JW-R1216CT	JW-R1418CT	JW-R1520CT	JW-R1622CT	JW-R1826CT
Name	Rectangle Anti-Skid Tray	Rectangle Anti-Skid Tray	Rectangle Anti-Skid Tray	Rectangle Anti-Skid Tray	Rectangle Anti-Skid Tray
Size	415x305 mm	460x355 mm	515x380 mm	560x405 mm	650x450 mm
PCS/CTN	12	12	12	12	6



Art.No.	JW-R3020CT	JW-R2500CT	JW-R2700CT	JW-R2900CT	JW-R3100CT
Name	Rectangle Anti-Skid Tray	Oval Anti-Skid Tray	Oval Anti-Skid Tray	Oval Anti-Skid Tray	Oval Anti-Skid Tray
Size	750x480 mm	590x490 mm	685x560 mm	735x600 mm	800x600 mm
PCS/CTN	6	6	6	6	6

# Buffetwares

## Crocks

- Made of durable SAN.
- Resistant to stains, impact and food acids.
- Highly glossy surface ensures them a good ideal for buffets or sandwich shops.

Material: AS

Colour: Clear/Red/Black/White

Art.No.	P-041	P-042	P-043
<b>Name</b>	Small Crock	Medium Crock	Big Crock
<b>Size</b>	157x127x82 mm	263x172x82 mm	333x264x82 mm
<b>PCS/CTN</b>	48	24	12



## Lids

Art.No.	P-042A	P-043A
<b>Name</b>	Medium Lid	Big Lid
<b>Size</b>	237x149x35 mm	310x239x35 mm
<b>Colour</b>	Clear	Clear
<b>Material</b>	PC/AS	PC/AS
<b>PCS/CTN</b>	48	48



## Swirl Bowl

- Made of durable polycarbonate or impact resistant SAN.
- Beautiful swirl pattern makes the bowl ideal for serving fruits, salads, sauces and ice creams.
- 148ml and 384ml are available.

Material: PC

Colour: Clear/White/Black



Art.No.	P-001	P-002
<b>Name</b>	Small Swirl Bowl	Big Swirl Bowl
<b>Size</b>	Φ91x62 mm	Φ130.3x61 mm
<b>Capacity</b>	148ML	384ML
<b>PCS/CTN</b>	192	96



# Buffetwares

## Ladles <sup>NSF</sup>

- Made of anti-breakage polycarbonate.
- Designed with an angled handle to avoid the ladle to slip into bowls.
- Portion control helps to serve the perfect amount of dressing or food ingredient.

Material: PC

Colour: Clear/Red/Beige/Black



Art.No.	P-012	P-013	P-014
Name	Small Ladle	Medium Ladle	Big Ladle
Size	216 mm/8.5"	268 mm/10.5"	330 mm/13"
Capacity	25ml	30ml	30ml
CPCS/CTN	192	192	192



## Serving Spoon <sup>NSF</sup>

- Made of unbreakable polycarbonate.
- Lightweight and super tough construction makes no cracks, no dents and no rust.
- Featured with a notched back and a handle slot for easy rest or hanging.

Material: PC

Colour: Clear/Red/Beige/Black



Art.No.	P-015	P-017
Name	Small Perforated Spoon	Big Perforated Spoon
Size	283x73 mm/11x2.9"	333x73 mm/13x2.9"
PCS/CTN	192	192

## Solid Spoon



Art.No.	P-016	P-018
Name	Small Solid Spoon	Big Solid Spoon
Size	283x73 mm/11x2.9"	333x73 mm/13x2.9"
PCS/CTN	192	192

## Serving Spoon



Art.No.	P-003	P-004	P-005
Name	Small Serving Spoon	Serving Spoon	Big Serving Spoon
Size	206x38 mm/8x1.5"	260x43 mm/10x1.7"	260x43 mm/10x1.7"
PCS/CTN	192	192	192



# Buffetwares

## Tongs

- Made of anti-breakage polycarbonate.
- The flat tong is ribbed to ensure a secure hold.
- The scallop tong features an ergonomic design for a secure grip of items that are hard to hold.

Material: PC

Colour: Clear/Red/Beige/Black

Art.No.	P-006	P-007	P-008
<b>Name</b>	Small Scallop Tong	Medium Scallop Tong	Big Scallop Tong
<b>Size</b>	150mm/6"	230mm/9"	305mm/12"
<b>PCS/CTN</b>	384	192	96



Art.No.	P-009	P-010	P-011
<b>Name</b>	Small Flat Tong	Medium Flat Tong	Big Flat Tong
<b>Size</b>	150mm/6"	230mm/9"	305mm/12"
<b>PCS/CTN</b>	192	192	96



## Food Tongs

- Made of break resistant polycarbonate and good quality stainless steel.
- Streamline body provides an easy-cleaning.
- Scalloped edges serve a secure grip for items that are hard to hold.

Material: PC

Colour: Clear

Art.No.	P-050
<b>Name</b>	Food Tongs
<b>Size</b>	215 mm
<b>PCS/CTN</b>	96



## Salad Clip

- Made of PC material, it is firm and durable.
- Safe and hygienic, it meets request of NSF design.
- Ideal for buffets, restaurants or hotels.

Material: PC

Colour: Black/Red/White/Clear

Art.No.	JW-SL06	JW-SL09
<b>Name</b>	6" Salad Clip	9" Salad Clip
<b>Size</b>	160 mm/6.5"	235 mm/9.5"
<b>PCS/CTN</b>	192	192



# Buffetwares

## Condiment Jars

- Made of clear, break-resistant polycarbonate.
- Lids are slotted for serving spoons.
- Designed to hold condiments like mustard, ketchup, dressings etc.

Material: PC  
Colour: Clear

<b>Art.No.</b>	JW-CJ250
<b>Name</b>	Condiment Jars
<b>Size</b>	84x104mm
<b>Capacity</b>	250ml
<b>Material</b>	99g
<b>PCS/CTN</b>	96



## Dredges

- Made of clear, unbreakable polycarbonate.
- Can be cleaned in the dishwasher.
- It's easy to identify the condiments with lids in different colours.
- A staple in the kitchen or on the dining table.

Material: PC+PE  
Colour: Clear



Art.No.	JW-SK280N	JW-SK280M	JW-SK280D	JW-SK280F	JW-SK280C	JW-SK280P
<b>Name</b>	Shakers Complete With Solid Lid	Shakers Complete With Medium Ground Lid	Shakers Complete With Salt & Pepper Lid	Shakers Complete With Fine Ground Lid	Shakers Complete With Cheese Lid	Shakers Complete With Parsley Lid
<b>Size</b>	110x80x97mm	110x80x97mm	110x80x97mm	110x80x97mm	110x80x97mm	110x80x97mm
<b>Capacity</b>	280ml	280ml	280ml	280ml	280ml	280ml
<b>Material</b>	PC+PE	PC+PE	PC+PE	PC+PE	PC+PE	PC+PE
<b>PCS/CTN</b>	72	72	72	72	72	72

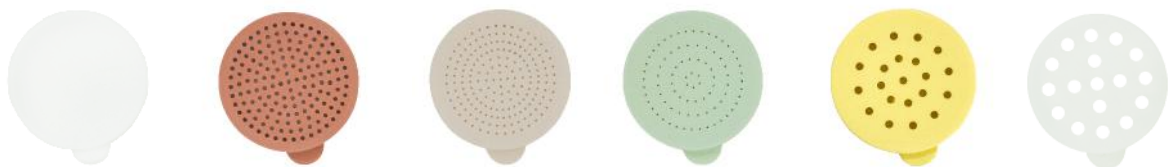

Art.No.	JW-SK280LN	JW-SK280LM	JW-SK280LD	JW-SK280LF	JW-SK280LC	JW-SK280LP
<b>Name</b>	Solid Lid	Medium Ground Lid	Salt & Pepper Lid	Fine Ground Lid	Cheese Lid	Parsley Lid
<b>Size</b>	80x10mm	80x10mm	80x10mm	80x10mm	80x10mm	110x80x97mm
<b>Colour</b>	White	Rose	Beige	Green	Yellow	White
<b>Material</b>	PE	PE	PE	PE	PE	PE
<b>PCS/CTN</b>	288	288	288	288	288	288



# Buffetwares

## Rectangular Pebbled Bowl

- Made of clear ,anti-breakage polycarbonate.
- Featured a textured body for an elegant look and to avoid scratches.
- Ideal for food display in buffets, hotels or parties.

Material: PC  
Colour: Clear



Art.No.	JW-W1290C	JW-W1511C
<b>Name</b>	Small Rectangular Pebbled Bowl	Big Rectangular Pebbled Bowl
<b>Size</b>	305x227x60 mm	370x270x70 mm
<b>Capacity</b>	2250ml	3000ml
<b>PCS/CTN</b>	24	24

**Note: This item requires a MOQ.**

## Round Salad Bowl

- Made of anti-breakage polycarbonate or impact resistant AS.
- Clear and elegant appearance is very suitable for food display and table service

Material: PC/AS  
Colour: Clear



PC Art.No. AS Art.No.	JW-W500C JW-W500A	JW-W600C JW-W600A	JW-W700C JW-W700A	JW-W800C JW-W800A	JW-W900C JW-W900A	JW-W1000C JW-W1000A
<b>Name</b>	Round Salad Bowl	Round Salad Bowl	Round Salad Bowl	Round Salad Bowl	Round Salad Bowl	Round Salad Bowl
<b>Size</b>	Φ120x55mm	Φ140x65mm	Φ170x75mm	Φ200x90mm	Φ230x100mm	Φ260x110mm
<b>Capacity</b>	300ml	450ml	700ml	1250ml	2000ml	3000ml
<b>PCS/CTN</b>	192	48	48	48	48	24

**Note: This item requires a MOQ.**

# Buffetwares

## Round Pebbled Bowls

- Made of clear and anti-breakage polycarbonate.
- Textured body features with a stylish appearance and scratch resistance.
- A ideal for buffet, hotel or party service.



Material: PC  
Colour: Clear



Art.No.	JW-S1000C	JW-S1200C	JW-S1500C	JW-S1800C
<b>Name</b>	Round Pebbled Bowls	Round Pebbled Bowls	Round Pebbled Bowls	Round Pebbled Bowls
<b>Size</b>	Φ260x100 mm	Φ300x110 mm	Φ375x135 mm	Φ445x140 mm
<b>Capacity</b>	3000ml	4750ml	9750ml	14800ml
<b>PCS/CTN</b>	48	48	24	12

Note: This item requires a MOQ.

## Square Salad Bowls

- Made of unbreakable polycarbonate.
- Elegant design provides good ideal for salad storage or table service.



Material: PC  
Colour: White



Art.No.	JW-SSB60	JW-SSB80	JW-SSB100	JW-SSB115
<b>Name</b>	Square Salad Bowls	Square Salad Bowls	Square Salad Bowls	Square Salad Bowls
<b>Size</b>	125x125x60 mm	140x140x80 mm	190x190x100 mm	240x240x115 mm
<b>Capacity</b>	300ml	550ml	1200ml	2500ml
<b>PCS/CTN</b>	192	96	48	48

Note: This item requires a MOQ.

# Buffetwares

## Food Cover

- Made of unbreakable polycarbonate or impact resistant SAN, transparent and attractive.
- Compared to metal, PC/AS covers are lighter and with better insulation effect.
- Featured with rust-resistant, easy-cleaning and no need for preheating.

Material: PC/AS  
Colour: Clear



## PC Cover

- Made of unbreakable polycarbonate.
- Light weight construction is unequalled in strength and durability.
- Heat and break resistant, can be used in insulated vans and can withstand high temperature up to 99°C(210°F )

Material: PC  
Colour: Clear



## AS Cover

- Made of transparent and lightweight SAN, providing the covers an easy handle and fast food identification
- It is not suggested to be used in insulated van or high-temperature environment.
- A cost-effective option.

Material: AS  
Colour: Clear



Round Food Covers



Oval Food Covers

PC Art.No. AS Art.No.	JW-8RP JW-8RA	JW-9RP JW-9RA	JW-10RP JW-10RA	JW-11RP JW-11RA	JW-12RP JW-12RA	JW-14RP JW-14RA
<b>Name</b>	8-Inch Round Food Covers	9-Inch Round Food Covers	10-Inch Round Food Covers	11-Inch Round Food Covers	12-Inch Round Food Covers	14-Inch Round Food Covers
<b>Size</b>	Φ214x214mm	Φ239x239mm	Φ264x264mm	Φ288x288mm	Φ315x315mm	Φ364x364mm
<b>Outside</b>	65mm	65mm	64mm	65mm	63mm	65mm
<b>Capacity</b>	PC/AS	PC/AS	PC/AS	PC/AS	PC/AS	PC/AS
<b>PCS/CTN</b>	36	36	36	36	36	36

PC Art.No. AS Art.No.	JW-10OP JW-10OA	JW-11OP JW-11OA	JW-12OP JW-12OA	JW-14OP JW-14OA
<b>Name</b>	8-Inch Oval Food Covers	11-Inch Oval Food Covers	12-Inch Oval Food Covers	14-Inch Oval Food Covers
<b>Size</b>	262x195mm	287x213mm	313x237mm	362x274mm
<b>Outside</b>	65mm	64mm	64mm	63mm
<b>Capacity</b>	PC/AS	PC/AS	PC/AS	PC/AS
<b>PCS/CTN</b>	36	36	36	36

**Note: This item requires a MOQ.**

# Plastic Barware



Art.No.	JW-BSK	JW-BSW	JW-BMC	JW-BSS	JW-BC	JW-BC2
<b>Name</b>	Cocktail Shaker	Cocktail Shaker	Cocktail Shaker	Salt&Sugar Glass Rimmer	Bar Caddy	Bar Caddy
<b>Size</b>	Φ94x60x170 mm	Φ94x60x170 mm	Φ87x61x145 mm	200x160x70 mm	240x150x105 mm	194x142x136 mm
<b>Capacity</b>	750ml	750ml	/	/	/	/
<b>Colour</b>	Primary	Black/Red	Clear	Black	Black	Black
<b>Material</b>	S/S	S/S /Vinyl	PC	ABS	ABS	ABS
<b>PCS/CTN</b>	24	24	24	24	24	24

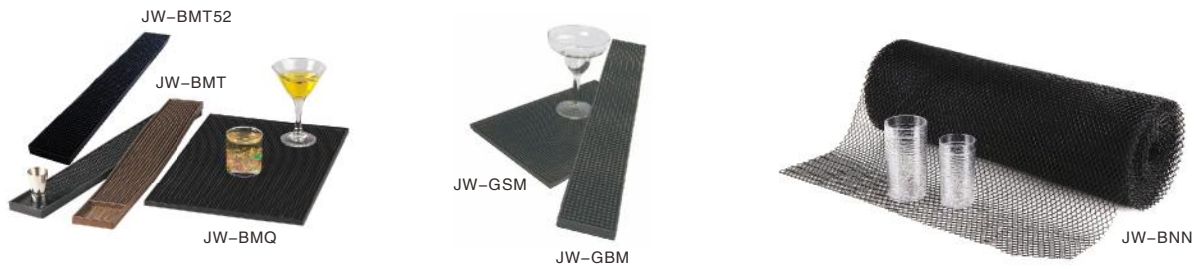

Art.No.	JW-BMQ	JW-GSM	JW-BMT	JW-GBM	JW-BMT52	JW-BNN
<b>Name</b>	Service Mat	Service Mat	Bar Mat	Bar Mat	Bar Mat	Non-Slip Bar Net
<b>Size</b>	450x300x10 mm	300x150x10 mm	602x80x18.5 mm	600x80x16 mm	520x80x15 mm	600x12000 mm
<b>Capacity</b>	/	/	/	/	/	/
<b>Colour</b>	Black/Brown	Black	Black/Brown	Black	Black	Black
<b>Material</b>	TPE	TPE	TPE	TPE	TPE	PE
<b>PCS/CTN</b>	12	12	12	12	12	1

**Note: Brown bar mat requires a MOQ.**



Art.No.	JW-MC20	JW-MC40	P-040	P-039	P-038	P-030
<b>Name</b>	20cc Measure Cup	40cc Measure Cup	Small Scoops	Medium Scoops	Big Scoops	Small Bar Muddler With Netted Head
<b>Size</b>	43x88 mm	48x106 mm	250x80x70mm	280x120x120mm	330x150x140mm	Φ27x210 mm
<b>Capacity</b>	10cc/20cc	20cc/40cc	6oz.	32oz.	64oz.	/
<b>Colour</b>	Clear	Clear	Clear	Clear	Clear	Black
<b>Material</b>	PC	PC	PC	PC	PC	ABS
<b>PCS/CTN</b>	64	64	36	36	36	216



Art.No.	P-031	P-032	P-033	P-034	P-035	P-036	P-037
<b>Name</b>	Small Bar Muddler With Triangular Head	Big Bar Muddler With Netted Head	Big Bar Muddler With Triangular Head	Small Bar Muddler With Netted Head	Small Bar Muddler With Triangular Head	Big Bar Muddler With Netted Head	Big Bar Muddler With Triangular Head
<b>Size</b>	Φ27x210 mm	Φ39.5x240 mm	Φ39.5x240 mm	Φ27x210 mm	Φ27x210 mm	Φ39.5x240 mm	Φ39.5x240 mm
<b>Colour</b>	Black	Black	Black	Black	Black	Black	Black
<b>Material</b>	ABS	ABS	ABS	PC	PC	PC	PC
<b>PCS/CTN</b>	216	216	216	216	216	216	216

# Plastic Barware

## Dual-way First In First Out Squeeze Bottle

- Made of environmental, non-toxic PE with blow molding process.
- Designed with double wide mouth for easy cleaning and fast filling.
- Operating concept; First In First Out
- Improving the utilization of sauce at least by 15%.
- Ideal for table or kitchen service
- The temperature range is from -40°C to 80°C (47.2°F -176°F )

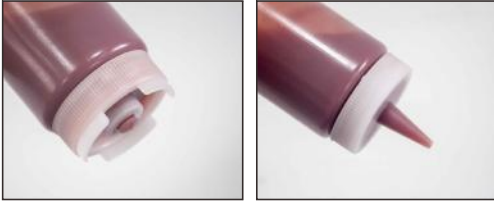

JW-FIFO12 JW-FIFO16 JW-FIFO20 JW-FIFO24 JW-FIFO32

JW-FIFO12	JW-FIFO16	JW-FIFO20	JW-FIFO24	JW-FIFO32
12.oz Dual-way First In First Out Squeeze Bottle	16.oz Dual-way First In First Out Squeeze Bottle	20.oz Dual-way First In First Out Squeeze Bottle	24.oz Dual-way First In First Out Squeeze Bottle	32.oz Dual-way First In First Out Squeeze Bottle
Φ62x167 mm	Φ62x208 mm	Φ70x208 mm	Φ75x208 mm	Φ87x208 mm
12.oz	16.oz	20.oz	24.oz	32.oz
Translucent	Translucent	Translucent	Translucent	Translucent
96	96	96	96	96



Art.No.	JW-LC46	JW-DC46	JW-TC46	JW-VC46	JW-HC46
<b>Name</b>	Label Cap	Fifo Bottle Dispensing Cap	Precision Tip Dispensing Cap	Vinegar Tip Dispensing Cap	Three-hole Tip Dispensing Cap
<b>Size</b>	Φ52x15 mm	Φ57x31mm	Φ57x46 mm	Φ57x31 mm	Φ57x50 mm
<b>Colour</b>	Translucent	Translucent	Translucent	Translucent	Translucent
<b>PCS/CTN</b>	64	64	64	64	64

## Store'N Pour



Art.No.	JW-BSP0.5	JW-BSP1	JW-BSP2	JW-BSP2.5	JW-LBSD8	JW-LBSD12	JW-LBSD24	JW-LBS32
<b>Name</b>	Store'N Pour	Store'N Pour	Store'N Pour	Store'N Pour	Squeeze Dispenser (Wide Mouth)	Squeeze Dispenser (Wide Mouth)	Squeeze Dispenser (Wide Mouth)	Squeeze Dispenser (Wide Mouth)
<b>Size</b>	Φ90x260 mm	Φ90x330 mm	Φ120x350 mm	Φ125x380 mm	Φ50x178 mm	Φ60x196 mm	Φ70x253 mm	Φ70x325mm
<b>Colour</b>	Brown/Red/Yellow/Blue/Green/Oragne/White/Clear				Red/Yellow/White/Clear			
<b>Capacity</b>	0.5L	1.0L	2.0L	2.5L	8oz.	12oz.	24oz.	32oz.
<b>Material</b>	PP+ABS	PP+ABS	PP+ABS	PP+ABS	PP+PE	PP+PE	PP+PE	PP+PE
<b>PCS/CTN</b>	48	48	48	48	240	240	240	240

# Plastic Barware

## 1L New Free Pour

- Made of high-density polyethylene and polypropylene.
- Juice flows out from a hole at the top.
- The small hole can control the flowing speed of juice.
- The top can be easily held.
- The product is easy to clean.
- A registered design with practicalities in mind as opposed to just pouring or storing.

<b>Art.No.</b>	<b>JW-BSNP1</b>
<b>Name</b>	1L New Free Pour
<b>Size</b>	Ø97x333 mm
<b>Capacity</b>	1L
<b>Material</b>	PE+PP
<b>Colour</b>	Red/Yellow/Blue Green/Orange /Primary
<b>PCS/CTN</b>	48



Art.No.	JW-B4B	JW-B6B	JW-B3B	JW-B5B	JW-BN3	JW-BN6D
<b>Name</b>	4-Compartment Condiment Holder	6-Compartment Condiment Holder	3-Compartment Condiment Holder	5-Compartment Condiment Holder	3-Deep Condiment Holder	6-Deep Condiment Holder
<b>Size</b>	500x160x90 mm	500x160x90 mm	500x160x90 mm	500x160x90 mm	474x168.5x180 mm	474x168x180 mm
<b>Material</b>	PC+PP+ABS	PC+PP+ABS	PC+PP+ABS	PC+PP+ABS	PC+ABS	PC+ABS
<b>Colour</b>	Clear/White/Black	Clear/White/Black	Clear/White/Black	Clear/White/Black	Clear/White/Black	Clear/White/Black
<b>PCS/CTN</b>	12	12	12	12	6	6



Art.No.	JW-BN6L	JW-SC78	JW-SC106	JW-SC110	JW-BO	JW-BV
<b>Name</b>	6-Deep Condiment Holder	Small Sugar Packet Holder	Medium Sugar Packet Holder	BIG Sugar Packet Holder	Bottle opener With Vinyl	Bottle opener Without Vinyl
<b>Size</b>	474x169x180 mm	78x52x51 mm	106x77x57 mm	110x65x55 mm	181x40mm	181x40mm
<b>Material</b>	PC+ABS	PC	PC	PC	S/S /Vinyl	S/S
<b>Colour</b>	Clear/White/Black	Clear	Clear	Clear	Red/Blue/Black	Primary
<b>PCS/CTN</b>	6	240	192	192	48	48

Note: Sugar packet holder requires a MOQ.

# Plastic Barware



Art.No.	JW-501	JW-BFW	JW-BFB	JW-BFG	JW-BW
<b>Name</b>	Wine Bucket	Flair Bottle	Flair Bottle	Flair Bottle	Whiskeygate Pourer
<b>Size</b>	Φ115x230 mm	Φ77x290 mm	Φ77x290 mm	Φ77x290 mm	/
<b>Colour</b>	Clear	White	White With Printed	Phosp horushorescent	Clear/Black/Green/Blue/Red/White
<b>Material</b>	AS	ABS	ABS	ABS	PC, TPE
<b>PCS/CTN</b>	12	24	24	24	360

Note: JW-BFG requires a MOQ.



Art.No.	JW-BG	JW-FP	JW-FPP	JW-BPP	JW-BP
<b>Name</b>	Whiskeygate Pourer	Free Pourer	Free Pourer	Chromed Metal Free Pourer	Chromed Plastic Free Pourer
<b>Colour</b>	Black/Red	Black	Black	Silver	Black
<b>Material</b>	EVA, PC, TPE	EVA, TPE, ABS	EVA, TPE, ABS	ABS, TPE, Chromed	ABS, TPE, S/S
<b>PCS/CTN</b>	360	360	360	360	360



Art.No.	JW-BS	JW-BA	JW-BB	JW-BH	JW-BR
<b>Name</b>	Plastic Free Pourer	Plastic Free Pourer	Measured Pourer	Measured	Economy Free Pourer
<b>Colour</b>	Clear	Clear	Black/Clear/Red	Clear/Black	Clear/White/Red/Blue/Yellow/Green/Black/Purple/Orange
<b>Material</b>	TPE, ABS	TPE, ABS	PC, AS, EVA	PC, TPE	TPE
<b>PCS/CTN</b>	360	960	360	360	960

# Plastic Barware

## Polycarbonate Pitcher <sup>NSF</sup>



Art.No.	JW-601	JW-602	JW-603	JW-609	JW-610
<b>Name</b>	Polycarbonate Pitcher	Polycarbonate Pitcher	Polycarbonate Pitcher	Polycarbonate Pitcher	Polycarbonate Pitcher
<b>Size</b>	Φ128x200 mm	Φ115x200 mm	Φ104x170 mm	Φ138x230 mm	Φ133x240 mm
<b>Capacity</b>	1.8L(60oz.)	1.4L(42oz.)	0.95L(28.5oz.)	1.9L(63oz.)	1.9L(63oz.)
<b>Colour</b>	Clear	Clear	Clear	Clear	Clear
<b>Material</b>	PC	PC	PC	PC	PC
<b>PCS/CTN</b>	24	24	24	24	24

## Measuring Cup <sup>NSF</sup>



Art.No.	JW-608C	JW-607C	JW-606C	JW-605C	JW-604C
<b>Name</b>	Measuring Cup	Measuring Cup	Measuring Cup	Measuring Cup	Measuring Cup
<b>Size</b>	Φ70x87 mm	Φ90x124 mm	Φ115x164 mm	Φ147x215 mm	Φ165x241 mm
<b>Capacity</b>	250ml	500ml	1000ml	2000ml	3000ml
<b>Colour</b>	Clear	Clear	Clear	Clear	Clear
<b>Material</b>	PC	PC	PC	PC	PC
<b>PCS/CTN</b>	48	48	24	24	24

## Measured Plastic Shaker



Art.No.	JW-X9001	JW-X8001	JW-X6001	JW-X4501	JW-X3001
<b>Name</b>	Measured Plastic Shaker	Measured Plastic Shaker	Measured Plastic Shaker	Measured Plastic Shaker	Measured Plastic Shaker
<b>Size</b>	Φ90x284.5 mm	Φ95x251 mm	Φ90x219.5 mm	Φ90x192 mm	Φ82x168 mm
<b>Capacity</b>	900ml	800ml	600ml	450ml	300ml
<b>Colour</b>	Clear	Clear	Clear	Clear	Clear
<b>Material</b>	PC	PC	PC	PC	PC
<b>PCS/CTN</b>	9	18	18	18	18

Note: This item requires a MOQ.

## Ice Bucket Series



Art.No.	JW-I001	JW-I002	JW-I003	JW-I004	JW-I005
<b>Name</b>	Ice Bucket Series	Ice Bucket Series	Ice Bucket Series	Ice Bucket Series	Ice Bucket Series
<b>Size</b>	120x140 mm	120x115 mm	125x130 mm	125x140 mm	195x210 mm
<b>Capacity</b>	1000ml	800ml	1000ml	1000ml	3000ml
<b>Colour</b>	Clear	Clear	Clear	Clear	Clear
<b>Material</b>	PC	PC	PC	PC	PC
<b>PCS/CTN</b>	24	24	24	24	4

Note: This item requires a MOQ.



# Aluminum Composite Shelving

## Aluminum Composite Shelving System

The bearing components of the shelving, including posts, post connectors, traverses. All are made of high-strength aluminum alloy and available in various sizes to ensure a high space utilization under different situations.



**Multi environments use  
From -38°C to 88°C**

**Stationary Units**

**Mobile Unit**

**Length: 905mm, 1085mm, 1265mm, 1355mm, 1535mm, 1805mm**

**Width: 360mm, 450mm, 540mm, 630mm**

**Height: 1550mm, 1700mm, 2000mm, 2450mm**

# Aluminum Composite Shelving

## Easy to Assemble & Adjust

Different heights of mounted hanging holes are preprocessed on the post and distributed evenly with 150mm increments, so the shelf can be adjusted without disassembling the entire unit. Corner connectors are applied to build a right-angled or U-shaped frame.

The bottle of the post is equipped with height-adjustable bolt and the unique designed self-locking nut, so a stable shelving is ensured even on the uneven floor.

## Weight Bearing Capacity

Each shelf can bear 170 to 250 KGS.

There is no loss of weight bearing capacity after an add-on unit was built up along a straight line.

Due to the weight bearing capacity of castors, the maximum weight bearing capacity of each moving shelf is 110 kg.

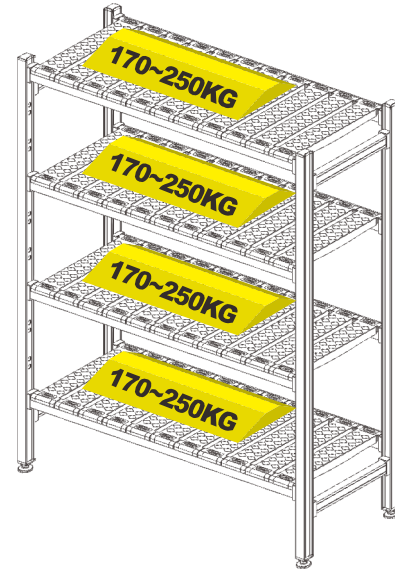

## Healthy and safety storage area

The shelf plates are made of high density anti-corrosion polypropylene, non-toxic and tasteless, ensuring a sanitary area for food storage.

Rust free and safe to  $-38^{\circ}\text{C}$ , making the shelving ideal for restaurant, bakeries, hospitals, storage rooms, freezers and so on. Detachable structure makes components removed or cleaned easily and quickly.

The design of product is compliance with NSF certification standards. (including castors)



## Absolutely solid, durable and stable

The weight bearing components of posts, traverses, post connectors, with the feature of high strength, corrosion resistance, durable, are made of aluminum alloy.

All aluminum components are extruded, then the oxidation technology is applied for the shelving surface. (15um thickness of the oxide layer) Thus the purpose of anti-oxidation and anti-corrosion achieved.

Safe to  $-38^{\circ}\text{C}$  ( $-36.4^{\circ}\text{F}$ ), ideal for freezers or any wet or humid environment.

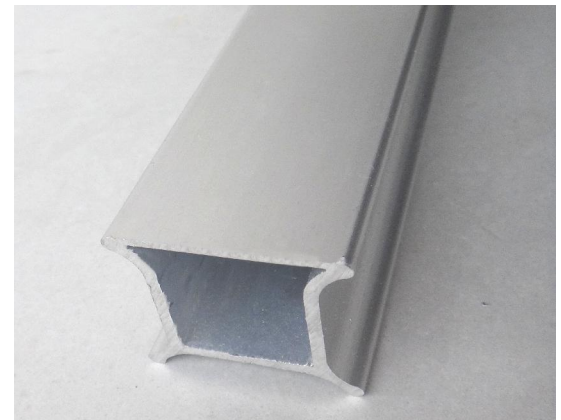

# Products Assembly

1 Assemble the top and bottom post connectors.



2 Assemble the traverses and install the shelf plates on the first tier.



3 Use the rubber hammer when installing the shelf plates.



4 Install the shelf plates of the second tier.



5 Install the shelf plates on third tier.



6 Install the top shelf plates.



## Casters



Art.No.	JW-SL	JW-SLB
Name	5" With Brake Caster	5" Without Brake Caster
Size	127mm / 5"	127mm / 5"

## Corner Connectors

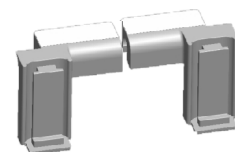

Art.No.	JW-SLPA
Name	Corner Connectors
Description	Including Right & Left

# Aluminum Composite Shelving

## Add-on Unit

When added to a basic unit, the traverse on the first and the second unit share the middle post.

## U-Shaped Unit

Using two sets of corner connectors on each side of a U-shaped unit.

## Corner Unit

Using one set of corner connectors per shelf to form corner units.

## Mobile Unit

Inserting the specialized bolts into the casters to change the storage shelves into the mobile aluminum shelving system. Mobile units are unsuitable to be used as transporting cart.

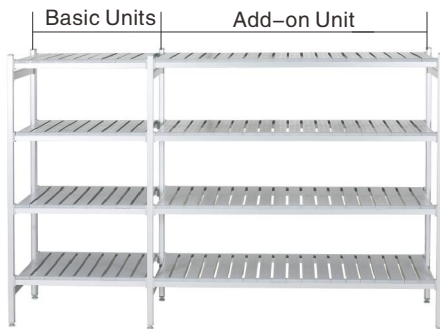

Add-on Unit



U-Shaped Unit



Corner Unit



Mobile Unit

## Shelf Kit

Width	Length	905 <sup>36"</sup> mm	1085 <sup>43"</sup> mm	1265 <sup>50"</sup> mm	1355 <sup>53"</sup> mm	1535 <sup>60"</sup> mm	1805 <sup>71"</sup> mm
360 <sup>14"</sup> mm	Art. No.	JW-SL3614	JW-SL4314	JW-SL5014	JW-SL5314	JW-S6014	JW-SL7114
450 <sup>18"</sup> mm	Art. No.	JW-SL3618	JW-SL4318	JW-SL5018	JW-SL5318	JW-S6018	JW-SL7118
540 <sup>21"</sup> mm	Art. No.	JW-SL3621	JW-SL4321	JW-SL5021	JW-SL5321	JW-S6021	JW-SL7121
630 <sup>25"</sup> mm	Art. No.	JW-SL3625	JW-SL4325	JW-SL5025	JW-SL5325	JW-S6025	JW-SL7125

# Aluminum Composite Shelving

61"  
1550 mm  
Basic Units



Width	Length	905 <sup>36"</sup> mm	1085 <sup>43"</sup> mm	1265 <sup>50"</sup> mm	1355 <sup>53"</sup> mm	1535 <sup>60"</sup> mm	1805 <sup>71"</sup> mm
360 <sup>14"</sup> mm	Art. No.	JW-SL36141	JW-SL43141	JW-SL50141	JW-SL53141	JW-S60141	JW-SL71141
450 <sup>18"</sup> mm	Art. No.	JW-SL36181	JW-SL43181	JW-SL50181	JW-SL53181	JW-S60181	JW-SL71181
540 <sup>21"</sup> mm	Art. No.	JW-SL36211	JW-SL43211	JW-SL50211	JW-SL53211	JW-S60211	JW-SL71211
630 <sup>25"</sup> mm	Art. No.	JW-SL36251	JW-SL43251	JW-SL50251	JW-SL53251	JW-S60251	JW-SL71251

67"  
1700 mm  
Basic Units



Width	Length	905 <sup>36"</sup> mm	1085 <sup>43"</sup> mm	1265 <sup>50"</sup> mm	1355 <sup>53"</sup> mm	1535 <sup>60"</sup> mm	1805 <sup>71"</sup> mm
360 <sup>14"</sup> mm	Art. No.	JW-SL36142	JW-SL43142	JW-SL50142	JW-SL53142	JW-S60142	JW-SL71142
450 <sup>18"</sup> mm	Art. No.	JW-SL36182	JW-SL43182	JW-SL50182	JW-SL53182	JW-S60182	JW-SL71182
540 <sup>21"</sup> mm	Art. No.	JW-SL36212	JW-SL43212	JW-SL50212	JW-SL53212	JW-S60212	JW-SL71212
630 <sup>25"</sup> mm	Art. No.	JW-SL36252	JW-SL43252	JW-SL50252	JW-SL53252	JW-S60252	JW-SL71252

79"  
2000 mm  
Basic Units



Width	Length	905 <sup>36"</sup> mm	1085 <sup>43"</sup> mm	1265 <sup>50"</sup> mm	1355 <sup>53"</sup> mm	1535 <sup>60"</sup> mm	1805 <sup>71"</sup> mm
360 <sup>14"</sup> mm	Art. No.	JW-SL36143	JW-SL43143	JW-SL50143	JW-SL53143	JW-S60143	JW-SL71143
450 <sup>18"</sup> mm	Art. No.	JW-SL36183	JW-SL43183	JW-SL50183	JW-SL53183	JW-S60183	JW-SL71183
540 <sup>21"</sup> mm	Art. No.	JW-SL36213	JW-SL43213	JW-SL50213	JW-SL53213	JW-S60213	JW-SL71213
630 <sup>25"</sup> mm	Art. No.	JW-SL36253	JW-SL43253	JW-SL50253	JW-SL53253	JW-S60253	JW-SL71253

96"  
2450 mm  
Basic Units



Width	Length	905 <sup>36"</sup> mm	1085 <sup>43"</sup> mm	1265 <sup>50"</sup> mm	1355 <sup>53"</sup> mm	1535 <sup>60"</sup> mm	1805 <sup>71"</sup> mm
360 <sup>14"</sup> mm	Art. No.	JW-SL36144	JW-SL43144	JW-SL50144	JW-SL53144	JW-S60144	JW-SL71144
450 <sup>18"</sup> mm	Art. No.	JW-SL36184	JW-SL43184	JW-SL50184	JW-SL53184	JW-S60184	JW-SL71184
540 <sup>21"</sup> mm	Art. No.	JW-SL36214	JW-SL43214	JW-SL50214	JW-SL53214	JW-S60214	JW-SL71214
630 <sup>25"</sup> mm	Art. No.	JW-SL36254	JW-SL43254	JW-SL50254	JW-SL53254	JW-S60254	JW-SL71254

# Winshelvings

Multi environments use  
From  $-38^{\circ}\text{C}$  to  $88^{\circ}\text{C}$

Stationary Units

Mobile Units

High-Density Units

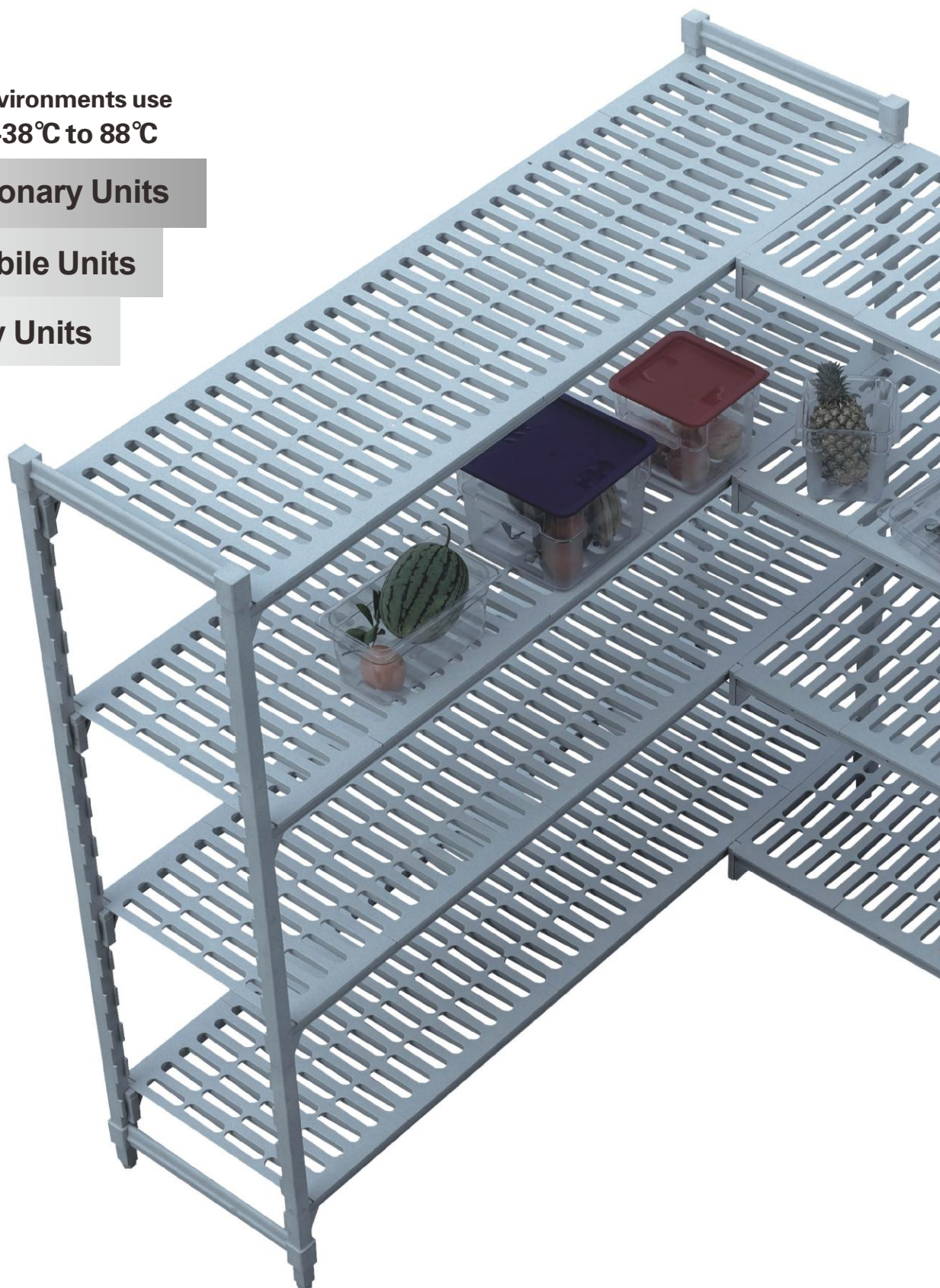

# Winshelvings

## Easy to adjust and install

It's easy to adjust and install.  
With different sizes (3 heights, 4 widths, 6 lengths), space utilization is highly increased.  
The nets can be adjusted up or down by 100 millimeters with disassembly.  
Shelves can be built to U-shape units with corner connectors.

## Absolutely firm, durable and stable

Made from a steel core and polypropylene.  
Inner steel provides high intensity and durability.  
Exterior PP is anti-corrosion and break-resistant  
Post connectors provide exceptional stabilization.

## Never rust

Can be used anywhere, no matter moist or dry  
weldless, never rust  
Resists corrosion by brine or marine air  
Suitable for coolers and freezers, available  
under -38°C

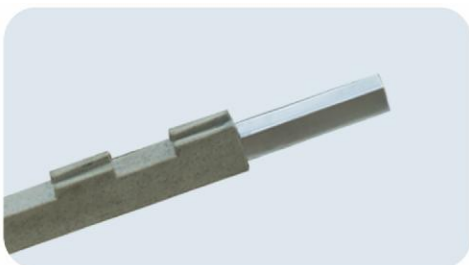

# Winshelvings

## Basic Unit

The components of shelf can be formed into various specifications of basic units.



Vented Basic Unit



Solid Basic Unit

## Add-on Unit

When added to a basic unit, the traverses on the first and second unit share the middle post. As a result, only two additional posts, instead of four posts or any add-on clips, are needed.



## Corner Unit and U shape Unit

Corner connectors can build corner units and U-shape units. Traverses snap onto corner connectors just like they snap onto the dovetails of the posts.

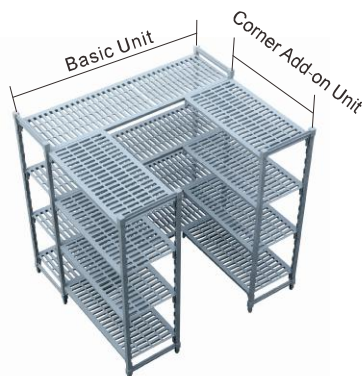
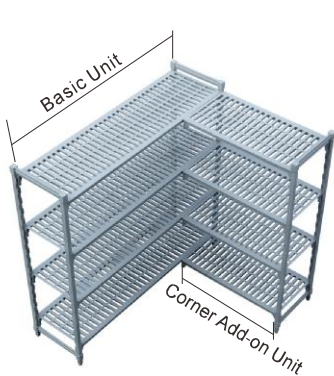

## Mobile Unit

Inserting the specialized bolts into the casters to change the storage shelves into the move aluminum shelving system. Mobile units are unsuitable to be used as transporting cart.



## Heavy-duty Rack

To store frozen, cold and dry items 22.5cm safely off the floor. Rust free, corrosion proof and non-blending, the maximum weight load is 350kg. Different sizes of 6 heights, 4 widths of corner connectors and dunnage stand are available. Above 1220mm size must be assembled with dunnage stands and corner connectors to make sure its load capacity.



Vented Dunnage Rack



SolidDunnage Rack



# Winshelvings Size Diagram

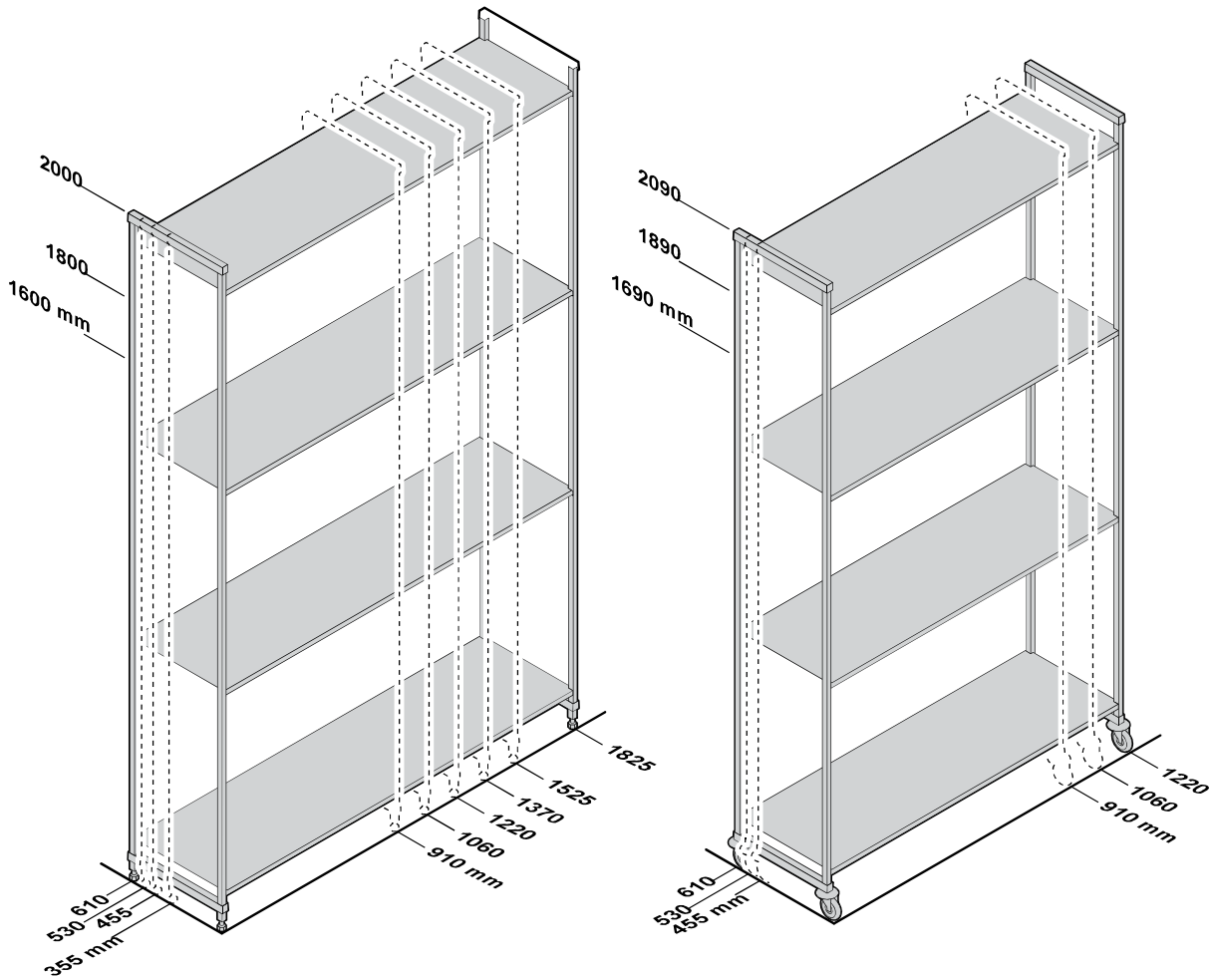

**Stationary Units**

**Mobile Unit**

## Weight Bearing Capacity

Weight must be evenly distributed throughout the frame.

		Length 910-1220 mm	Width 1370-1825mm
Single Unite	Weight Bearing capacity per for shelves	1400 kg	1000 kg
	Weight Bearing capacity per unit	350	250
Corner Unit	Weight Bearing capacity per for shelves	600	—
	Weight Bearing capacity per unit	150	—
Mobile Unit	Weight Bearing capacity per for shelves	340	—
Dunnage Stand	Single Unite	450	—

Note: As the casters have load-bearing capacity, the maximum load-bearing capacity of the mobile frame is 340 kg.

# Winshelvings Parts

## Casters

It is suitable for all storage areas, especially for refrigerated rooms and wet areas. It consists of highly durable, non-corroded plastic and 127mm non-marking thermoplastic rubber universal wheel.

Art.No.	PSL	PS
Direction	With Brake	Without Brake
Size	127mm / 5"	127mm / 5"



## Corner Connector Set

Corner connectors can be used to build corner units or U-shaped units. A set of corner connectors is needed for each shelf. When corner connectors are used, weight bearing capacity will be decreased to 180kg per shelf. Recommended for travelers equal to or shorter than 1220mm.



Tool for assembling removing corner connector.



PCC Including tow about

## Shelf Plates

The material of shelf plates is polypropylene. The design of shelf plates is solid or vented.



Vented Shelf Kits



Solid Shelf Kits

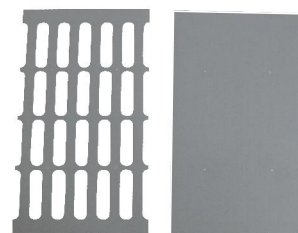

## Post Connectors

Post connectors hold two posts together and define the width of the unit. Be made of polypropylene, provide exceptional cross stabilization.



上横梁

Top



下横梁

Bottom

## Dunnage Stand



Recommended for 1370mm or longer. Recommended for weight bearing capacity to 450kg on the bottom shelf.



# Winshelvings Parts

## Fence system

Used to prevent the stored items from falling off shelving.  
Ideal for mobile shelving units.

	Fits Traverse	910 <sup>36"</sup> mm	1060 <sup>42"</sup> mm	1220 <sup>48"</sup> mm	1370 <sup>54"</sup> mm	1525 <sup>60"</sup> mm	1825 <sup>72"</sup> mm
	Art.No.	FSD362	FSD422	FSD482	FSD542	FSD602	FSD722
	Brackets	2	3	4	4	4	5
	Rods	2	2	2	2	2	2
	Rods Length	Φ 10x830	Φ 10x980	Φ 10x1140	Φ 10x1290	Φ 10x1445	Φ 10x1750
	Art.No.	FSS361	FSS421	FSS481	FSS541	FSS601	FSS721
	Brackets	2	3	3	4	4	5
	Rods	1	1	1	1	1	1
	Rods Length	Φ 10x830	Φ 10x980	Φ 10x1140	Φ 10x1290	Φ 10x1445	Φ 10x1750
	Fits Post Connector	355 <sup>14"</sup> mm	455 <sup>18"</sup> mm	530 <sup>21"</sup> mm	610 <sup>24"</sup> mm		
	Art.No.	FSE14	FSE18	FSE21	FSE24		
	Brackets	2	2	2	2		
	Rods Length	Φ 10x253	Φ 10x353	Φ 10x428	Φ 10x508		

## Stationary Post kits And Accessories

	Height	Width	355 <sup>14"</sup> mm	455 <sup>18"</sup> mm	530 <sup>21"</sup> mm	610 <sup>24"</sup> mm
	1600 <sup>64"</sup> mm	Art.No.	PSPK1464	PSPK1864	PSPK2164	PSPK2464
		Weight/Cube	6.06/0.0150	6.28/0.0150	6.48/0.0150	6.62/0.0150
	1800 <sup>72"</sup> mm	Art.No.	PSPK1472	PSPK1872	PSPK2172	PSPK2472
		Weight/Cube	6.72/0.0160	6.94/0.0160	7.14/0.0160	7.28/0.0160
	2000 <sup>80"</sup> mm	Art.No.	PSPK1480	PSPK1880	PSPK2180	PSPK2480
		Weight/Cube	7.76/0.0182	7.98/0.0182	8.18/0.0182	8.32/0.0182

Case Pack: 1 Colour:Spot Dust

## Winshelvings PVC Cover

Height	Width	Length	910 <sup>36"</sup> mm	1060 <sup>42"</sup> mm	1220 <sup>48"</sup> mm	1370 <sup>54"</sup> mm	1525 <sup>60"</sup> mm
	530 <sup>21"</sup> mm	Art.No.	JW-PSU362172VC	JW-PSU422172VC	JW-PSU482172VC	JW-PSU542172VC	JW-PSU602172VC
		Size	528x912x1800	528x1065x1800	528x1223x1800	528x1374x1800	528x1530x1800
	1800 <sup>72"</sup> mm	Art.No.	JW-PSU362472VC	JW-PSU422472VC	JW-PSU482472VC	JW-PSU542472VC	JW-PSU602472VC
		Size	606x912x1800	606x1065x1800	606x1223x1800	606x1374x1800	606x1530x1800

# Winshelvings

## Heaver Dunnage Rack



Height: 255mm 12"

Width	Length	910 <sup>36"</sup> mm	1060 <sup>42"</sup> mm	1220 <sup>48"</sup> mm	1370 <sup>54"</sup> mm	1525 <sup>60"</sup> mm	1825 <sup>72"</sup> mm	垫货支架
355 <sup>14"</sup> mm	Art.No.	PSH3614	PSH4214	PSH4814	PSH5414	PSH6014	PSH7214	—————
	Weight	7.46	8.09	8.76	9.48	10.63	11.63	1.05
455 <sup>18"</sup> mm	Art.No.	PSH3618	PSH4218	PSH4818	PSH5418	PSH6018	PSH7218	—————
	Weight	8.40	9.13	9.94	10.76	11.56	13.24	1.15
530 <sup>21"</sup> mm	Art.No.	PSH3621	PSH4221	PSH4821	PSH5421	PSH6021	PSH7221	—————
	Weight	9.15	9.89	10.79	11.62	12.43	14.21	1.24
610 <sup>24"</sup> mm	Art.No.	PSH3624	PSH4224	PSH4824	PSH5424	PSH6024	PSH7224	—————
	Weight	9.48	10.6	11.17	12.14	13.09	14.87	1.34

## Vented Shelf Kits

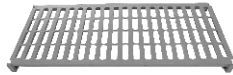

Width	Length	910 <sup>36"</sup> mm	1060 <sup>42"</sup> mm	1220 <sup>48"</sup> mm	1370 <sup>54"</sup> mm	1525 <sup>60"</sup> mm	1825 <sup>72"</sup> mm
355 <sup>14"</sup> mm	Art.No.	PS3614VK	PS4214VK	PS4814VK	PS5414VK	PS6014VK	PS7214VK
	Weight	4.00	4.61	5.29	6.03	6.72	11.17
455 <sup>18"</sup> mm	Art.No.	PS3618VK	PS4218VK	PS4818VK	PS5418VK	PS6018VK	PS7218VK
	Weight	4.64	5.35	6.17	7.01	7.79	12.48
530 <sup>21"</sup> mm	Art.No.	PS3621VK	PS4221VK	PS4821VK	PS5421VK	PS6021VK	PS7221VK
	Weight	5.01	5.73	6.64	7.49	8.30	13.09
610 <sup>24"</sup> mm	Art.No.	PS3624VK	PS4224VK	PS4824VK	PS5424VK	PS6024VK	PS7224VK
	Weight	5.15	6.01	6.83	7.89	8.75	13.59

## Solid Shelf Kits



Width	Length	910 <sup>36"</sup> mm	1060 <sup>42"</sup> mm	1220 <sup>48"</sup> mm	1370 <sup>54"</sup> mm	1525 <sup>60"</sup> mm	1825 <sup>72"</sup> mm
455 <sup>18"</sup> mm	Art.No.	PS3618SK	PS4218SK	PS4818SK	PS5418SK	PS6018SK	PS7218SK
	Weight	4.77	5.52	6.32	7.21	8.02	12.41
530 <sup>21"</sup> mm	Art.No.	PS3621SK	PS4221SK	PS4821SK	PS5421SK	PS6021SK	PS7221SK
	Weight	5.02	5.75	6.66	7.52	7.69	13.12
610 <sup>24"</sup> mm	Art.No.	PS3624SK	PS4224SK	PS4824SK	PS5424SK	PS6024SK	PS7224SK
	Weight	5.35	6.18	7.13	8.08	9.00	13.93

# Winshelvings

## 64" 1600 mm Vented Starter Units



Width	Length	910 <sup>36"</sup> mm	1060 <sup>42"</sup> mm	1220 <sup>48"</sup> mm	1370 <sup>54"</sup> mm	1525 <sup>60"</sup> mm	1825 <sup>72"</sup> mm
355 <sup>14"</sup> mm	Art.No.	PSU361464	PSU421464	PSU481464	PSU541464	PSU601464	PSU721464
	Weight/Cube	28.40/0.076	31.15/0.092	33.91/0.096	37.31/0.112	40.76/0.114	45.09/0.143
455 <sup>18"</sup> mm	Art.No.	PSU361864	PSU421864	PSU481864	PSU541864	PSU601864	PSU721864
	Weight/Cube	31.30/0.084	34.47/0.100	37.76/0.106	41.58/0.122	45.34/0.127	21.02/0.154
530 <sup>21"</sup> mm	Art.No.	PSU362164	PSU422164	PSU482164	PSU542164	PSU602164	PSU722164
	Weight/Cube	33.14/0.098	36.41/0.114	39.86/0.128	43.78/0.134	47.46/0.145	53.53/0.172
610 <sup>24"</sup> mm	Art.No.	PSU362464	PSU422464	PSU482464	PSU542464	PSU602464	PSU722464
	Weight/Cube	33.97/0.103	37.86/0.113	40.97/0.137	45.49/0.148	49.89/0.156	55.65/0.189

## 72" 1800 mm Vented Starter Units



Width	Length	910 <sup>36"</sup> mm	1060 <sup>42"</sup> mm	1220 <sup>48"</sup> mm	1370 <sup>54"</sup> mm	1525 <sup>60"</sup> mm	1825 <sup>72"</sup> mm
355 <sup>14"</sup> mm	Art.No.	PSU361472	PSU421472	PSU481472	PSU541472	PSU601472	PSU721472
	Weight/Cube	30.15/0.078	32.50/0.094	35.66/0.098	39.06/0.114	42.51/0.116	46.84/0.145
455 <sup>18"</sup> mm	Art.No.	PSU361872	PSU421872	PSU481872	PSU541872	PSU601872	PSU721872
	Weight/Cube	33.05/0.086	36.22/0.102	39.51/0.108	43.33/0.124	47.09/0.129	52.77/0.156
530 <sup>21"</sup> mm	Art.No.	PSU362172	PSU422172	PSU482172	PSU542172	PSU602172	PSU722172
	Weight/Cube	34.89/0.100	38.16/0.116	41.61/0.130	45.53/0.138	49.21/0.147	55.28/0.174
610 <sup>24"</sup> mm	Art.No.	PSU362472	PSU422472	PSU482472	PSU542472	PSU602472	PSU722472
	Weight/Cube	35.72/0.107	39.61/0.117	42.72/0.140	47.24/0.160	51.64/0.161	57.40/0.202

## 80" 2000 mm Vented Starter Units



Width	Length	910 <sup>36"</sup> mm	1060 <sup>42"</sup> mm	1220 <sup>48"</sup> mm	1370 <sup>54"</sup> mm	1525 <sup>60"</sup> mm	1825 <sup>72"</sup> mm
355 <sup>14"</sup> mm	Art.No.	PSU361480	PSU421480	PSU481480	PSU541480	PSU601480	PSU721480
	Weight/Cube	31.12/0.081	33.47/0.097	36.63/0.101	40.48/0.119	43.48/0.119	47.81/0.148
455 <sup>18"</sup> mm	Art.No.	PSU361880	PSU421880	PSU481880	PSU541880	PSU601880	PSU721880
	Weight/Cube	34.42/0.089	37.19/0.105	40.48/0.111	44.30/0.127	48.06/0.132	53.74/0.159
530 <sup>21"</sup> mm	Art.No.	PSU362180	PSU422180	PSU482180	PSU542180	PSU602180	PSU722180
	Weight/Cube	35.86/0.103	39.13/0.119	42.58/0.133	46.50/0.141	50.18/0.150	56.25/0.177
610 <sup>24"</sup> mm	Art.No.	PSU362480	PSU422480	PSU482480	PSU542480	PSU602480	PSU722480
	Weight/Cube	36.69/0.110	40.58/0.120	43.69/0.143	48.21/0.163	52.61/0.164	58.37/0.205

# Winshelvings

64"  
1600 mm



## Vented Starter Add-on Units

Width	Length	910 <sup>36"</sup> mm	1060 <sup>42"</sup> mm	1220 <sup>48"</sup> mm	1370 <sup>54"</sup> mm	1525 <sup>60"</sup> mm	1825 <sup>72"</sup> mm
355 <sup>14"</sup> mm	Art.No.	PSA361464	PSA421464	PSA481464	PSA541464	PSA601464	PSA721464
	Weight/Cube	22.28/0.076	25.03/0.092	27.79/0.096	31.19/0.112	34.64/0.114	38.97/0.143
455 <sup>18"</sup> mm	Art.No.	PSA361864	PSA421864	PSA481864	PSA541864	PSA601864	PSA721864
	Weight/Cube	24.97/0.084	28.14/0.100	31.43/0.106	35.25/0.122	39.01/0.127	44.69/0.154
530 <sup>21"</sup> mm	Art.No.	PSA362164	PSA422164	PSA482164	PSA542164	PSA602164	PSA722164
	Weight/Cube	26.66/0.098	29.93/0.114	33.38/0.128	37.30/0.134	40.98/0.145	47.05/0.172
610 <sup>24"</sup> mm	Art.No.	PSA362464	PSA422464	PSA482464	PSA542464	PSA602464	PSA722464
	Weight/Cube	27.28/0.103	31.18/0.113	34.28/0.137	38.80/0.148	43.20/0.156	48.96/0.189

72"  
1800 mm



## Vented Starter Add-on Units

Width	Length	910 <sup>36"</sup> mm	1060 <sup>42"</sup> mm	1220 <sup>48"</sup> mm	1370 <sup>54"</sup> mm	1525 <sup>60"</sup> mm	1825 <sup>72"</sup> mm
355 <sup>14"</sup> mm	Art.No.	PSA361472	PSA421472	PSA481472	PSA541472	PSA601472	PSA721472
	Weight/Cube	23.16/0.078	25.51/0.094	28.67/0.098	32.09/0.114	35.52/0.116	39.85/0.145
455 <sup>18"</sup> mm	Art.No.	PSA361872	PSA421872	PSA481872	PSA541872	PSA601872	PSA721872
	Weight/Cube	25.85/0.086	29.02/0.102	32.31/0.108	36.13/0.124	39.89/0.129	45.57/0.156
530 <sup>21"</sup> mm	Art.No.	PSA362172	PSA422172	PSA482172	PSA542172	PSA602172	PSA722172
	Weight/Cube	27.54/0.100	30.81/0.116	34.26/0.130	38.18/0.138	41.86/0.147	47.93/0.174
610 <sup>24"</sup> mm	Art.No.	PSA362472	PSA422472	PSA482472	PSA542472	PSA602472	PSA722472
	Weight/Cube	28.15/0.107	32.04/0.117	35.15/0.140	39.68/0.160	44.07/0.161	49.83/0.202

80"  
2000 mm



## Vented Starter Add-on Units

Width	Length	910 <sup>36"</sup> mm	1060 <sup>42"</sup> mm	1220 <sup>48"</sup> mm	1370 <sup>54"</sup> mm	1525 <sup>60"</sup> mm	1825 <sup>72"</sup> mm
355 <sup>14"</sup> mm	Art.No.	PSA361480	PSA421480	PSA481480	PSA541480	PSA601480	PSA721480
	Weight/Cube	23.64/0.081	25.99/0.097	29.15/0.101	32.55/0.119	36.00/0.119	40.33/0.148
455 <sup>18"</sup> mm	Art.No.	PSA361880	PSA421880	PSA481880	PSA541880	PSA601880	PSA721880
	Weight/Cube	26.73/0.089	29.50/0.105	32.79/0.111	36.60/0.127	40.37/0.132	46.05/0.159
530 <sup>21"</sup> mm	Art.No.	PSA362180	PSA422180	PSA482180	PSA542180	PSA602180	PSA722180
	Weight/Cube	28.02/0.103	31.29/0.119	34.74/0.133	38.66/0.141	42.34/0.150	48.41/0.177
610 <sup>24"</sup> mm	Art.No.	PSA362480	PSA422480	PSA482480	PSA542480	PSA602480	PSA722480
	Weight/Cube	28.68/0.110	32.57/0.120	35.68/0.143	40.20/0.163	44.60/0.164	50.36/0.205

# Winshelvings

**64"**  
**1600 mm**  
**Solid Starter Units**



Width	Length	910 <sup>36"</sup> mm	1060 <sup>42"</sup> mm	1220 <sup>48"</sup> mm	1370 <sup>54"</sup> mm	1525 <sup>60"</sup> mm	1825 <sup>72"</sup> mm
455 <sup>18"</sup> mm	Art.No.	PSS361864	PSS421864	PSS481864	PSS541864	PSS601864	PSS721864
	Weight/Cube	31.67/0.084	34.95/0.100	38.22/0.106	42.15/0.122	45.91/0.127	51.50/0.154
530 <sup>21"</sup> mm	Art.No.	PSS362164	PSS422164	PSS482164	PSS542164	PSS602164	PSS722164
	Weight/Cube	33.21/0.098	36.49/0.114	40.09/0.128	43.97/0.134	47.89/0.145	53.53/0.172
610 <sup>24"</sup> mm	Art.No.	PSS362464	PSS422464	PSS482464	PSS542464	PSS602464	PSS722464
	Weight/Cube	35.85/0.103	39.45/0.113	43.28/0.137	47.41/0.148	51.60/0.156	57.85/0.189

**72"**  
**1800 mm**  
**Solid Starter Units**

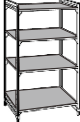

Width	Length	910 <sup>36"</sup> mm	1060 <sup>42"</sup> mm	1220 <sup>48"</sup> mm	1370 <sup>54"</sup> mm	1525 <sup>60"</sup> mm	1825 <sup>72"</sup> mm
455 <sup>18"</sup> mm	Art.No.	PSS361872	PSS421872	PSS481872	PSS541872	PSS601872	PSS721872
	Weight/Cube	33.42/0.086	36.70/0.102	39.97/0.108	43.90/0.124	48.08/0.129	53.25/0.156
530 <sup>21"</sup> mm	Art.No.	PSS362172	PSS422172	PSS482172	PSS542172	PSS602172	PSS722172
	Weight/Cube	34.96/0.100	38.24/0.116	41.84/0.130	45.72/0.138	49.63/0.147	55.28/0.174
610 <sup>24"</sup> mm	Art.No.	PSS362472	PSS422472	PSS482472	PSS542472	PSS602472	PSS722472
	Weight/Cube	37.60/0.107	41.10/0.117	54.03/0.140	49.16/0.160	53.35/0.161	59.60/0.202

**80"**  
**2000 mm**  
**Solid Starter Units**



Width	Length	910 <sup>36"</sup> mm	1060 <sup>42"</sup> mm	1220 <sup>48"</sup> mm	1370 <sup>54"</sup> mm	1525 <sup>60"</sup> mm	1825 <sup>72"</sup> mm
455 <sup>18"</sup> mm	Art.No.	PSS361880	PSS421880	PSS481880	PSS541880	PSS601880	PSS721880
	Weight/Cube	34.15/0.089	37.67/0.105	40.94/0.111	44.87/0.127	49.05/0.132	54.32/0.159
530 <sup>21"</sup> mm	Art.No.	PSS362180	PSS422180	PSS482180	PSS542180	PSS602180	PSS722180
	Weight/Cube	35.97/0.103	39.21/0.119	42.81/0.133	46.69/0.141	50.61/0.150	56.25/0.177
610 <sup>24"</sup> mm	Art.No.	PSS362480	PSS422480	PSS482480	PSS542480	PSS602480	PSS722480
	Weight/Cube	38.57/0.110	42.07/0.120	46.00/0.143	50.13/0.163	54.32/0.164	60.57/0.205

# Winshelvings

64"  
1600 mm

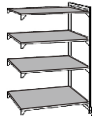

## Solid Starter Add-on Units

Width	Length	910 <sup>36"</sup> mm	1060 <sup>42"</sup> mm	1220 <sup>48"</sup> mm	1370 <sup>54"</sup> mm	1525 <sup>60"</sup> mm	1825 <sup>72"</sup> mm
455 <sup>18"</sup> mm	Art.No.	PSD361864	PSD421864	PSD481864	PSD541864	PSD601864	PSD721864
	Weight/Cube	25.34/0.084	28.63/0.100	31.89/0.106	35.82/0.122	40.00/0.127	45.17/0.154
530 <sup>21"</sup> mm	Art.No.	PSD362164	PSD422164	PSD482164	PSD542164	PSD602164	PSD722164
	Weight/Cube	26.73/0.098	30.01/0.114	33.61/0.128	37.49/0.134	41.47/0.145	47.05/0.172
610 <sup>24"</sup> mm	Art.No.	PSD362464	PSD422464	PSD482464	PSD542464	PSD602464	PSD722464
	Weight/Cube	29.16/0.103	32.66/0.113	36.59/0.137	40.72/0.148	44.91/0.156	51.16/0.189

72"  
1800 mm



## Solid Starter Add-on Units

Width	Length	910 <sup>36"</sup> mm	1060 <sup>42"</sup> mm	1220 <sup>48"</sup> mm	1370 <sup>54"</sup> mm	1525 <sup>60"</sup> mm	1825 <sup>72"</sup> mm
455 <sup>18"</sup> mm	Art.No.	PSD361872	PSD421872	PSD481872	PSD541872	PSD601872	PSD721872
	Weight/Cube	6.22/0.086	29.50/0.102	32.77/0.108	36.70/0.124	40.88/0.129	46.05/0.156
530 <sup>21"</sup> mm	Art.No.	PSD362172	PSD422172	PSD482172	PSD542172	PSD602172	PSD722172
	Weight/Cube	28.01/0.100	30.89/0.116	34.49/0.130	38.77/0.138	42.29/0.147	47.93/0.174
610 <sup>24"</sup> mm	Art.No.	PSD362472	PSD422472	PSD482472	PSD542472	PSD602472	PSD722472
	Weight/Cube	30.30/0.107	33.53/0.117	37.46/0.140	41.59/0.160	45.78/0.161	52.03/0.202

80"  
2000 mm



## Solid Starter Add-on Units

Width	Length	910 <sup>36"</sup> mm	1060 <sup>42"</sup> mm	1220 <sup>48"</sup> mm	1370 <sup>54"</sup> mm	1525 <sup>60"</sup> mm	1825 <sup>72"</sup> mm
455 <sup>18"</sup> mm	Art.No.	PSD361880	PSD421880	PSD481880	PSD541880	PSD601880	PSD721880
	Weight/Cube	27.10/0.089	29.98/0.105	33.25/0.111	37.17/0.127	41.36/0.132	46.53/0.159
530 <sup>21"</sup> mm	Art.No.	PSD362180	PSD422180	PSD482180	PSD542180	PSD602180	PSD722180
	Weight/Cube	28.09/0.103	31.37/0.119	34.97/0.133	38.85/0.141	42.77/0.150	48.41/0.177
610 <sup>24"</sup> mm	Art.No.	PSD362480	PSD422480	PSD482480	PSD542480	PSD602480	PSD722480
	Weight/Cube	30.56/0.110	34.06/0.120	37.99/0.143	42.12/0.163	46.31/0.164	52.56/0.205



# Products Assembly

**⊘ DO NOT USE A METAL HAMMER FOR ASSEMBLY**

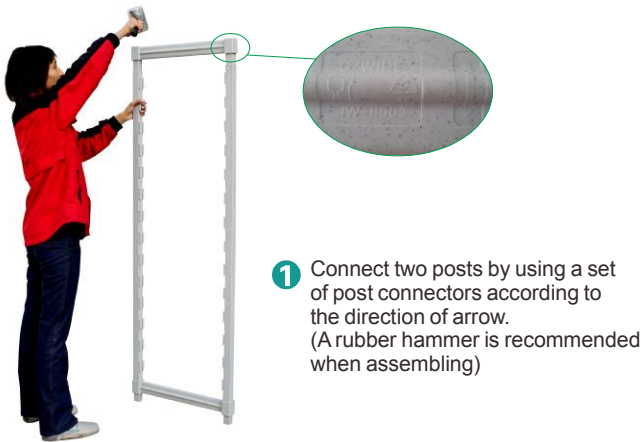

**1** Connect two posts by using a set of post connectors according to the direction of arrow. (A rubber hammer is recommended when assembling)

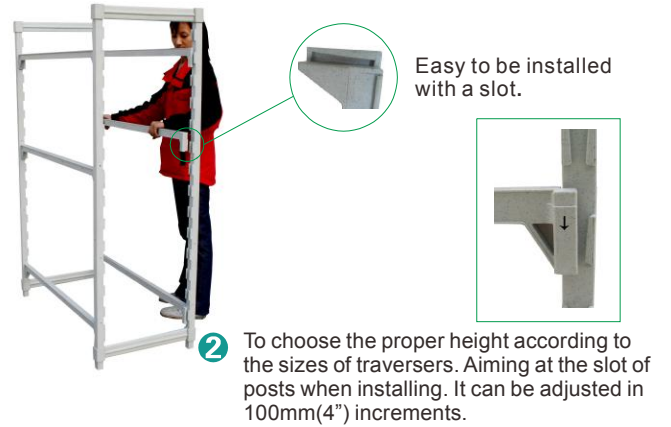

**2** To choose the proper height according to the sizes of traversers. Aiming at the slot of posts when installing. It can be adjusted in 100mm (4") increments.



**3** Place shelf plates on the traversers. First to put the plate on the side of traversers, then you can put the plate on the middle place of traversers according to the different sizes.

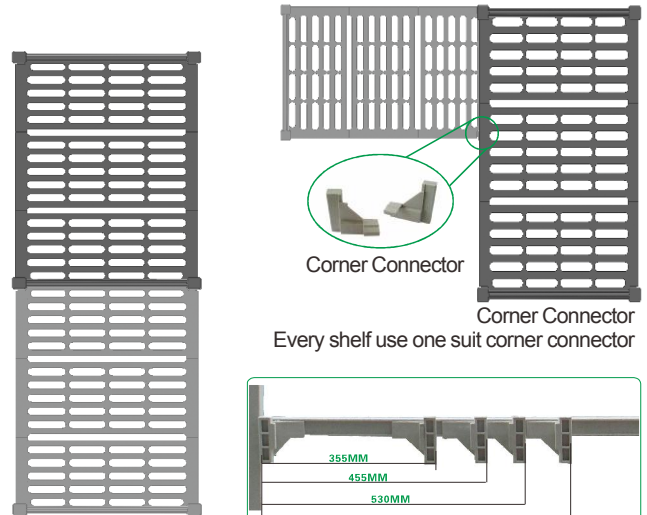

Corner Connector

Corner Connector

Every shelf use one suit corner connector

A common size in the corner

Dropped extender  
The basis of aircraft  
and dropped extender  
can be shared with the same post.



**4** Add an additional unit by connecting two more parts with post connectors and then setting traversers onto the dovetails on the posts. The traversers on the first and second unit share the middle post, place shelf plates on traversers to complete the second unit. Using corner connectors to add an additional unit.

# High Density Mobile Shelving Storage System

Maximum storage capacity can be achieved by forming a storage channel in all available space. The mobile shelving storage system is composed of the basic units on the raised track, with high density movable shelves in the middle. Tracks are easy to be installed without drilling or bonding.

**40%**  
Increase Storage  
Capacity

A: Stationary Units  
B: Mobile Units  
C: Track  
D: Active Aisle

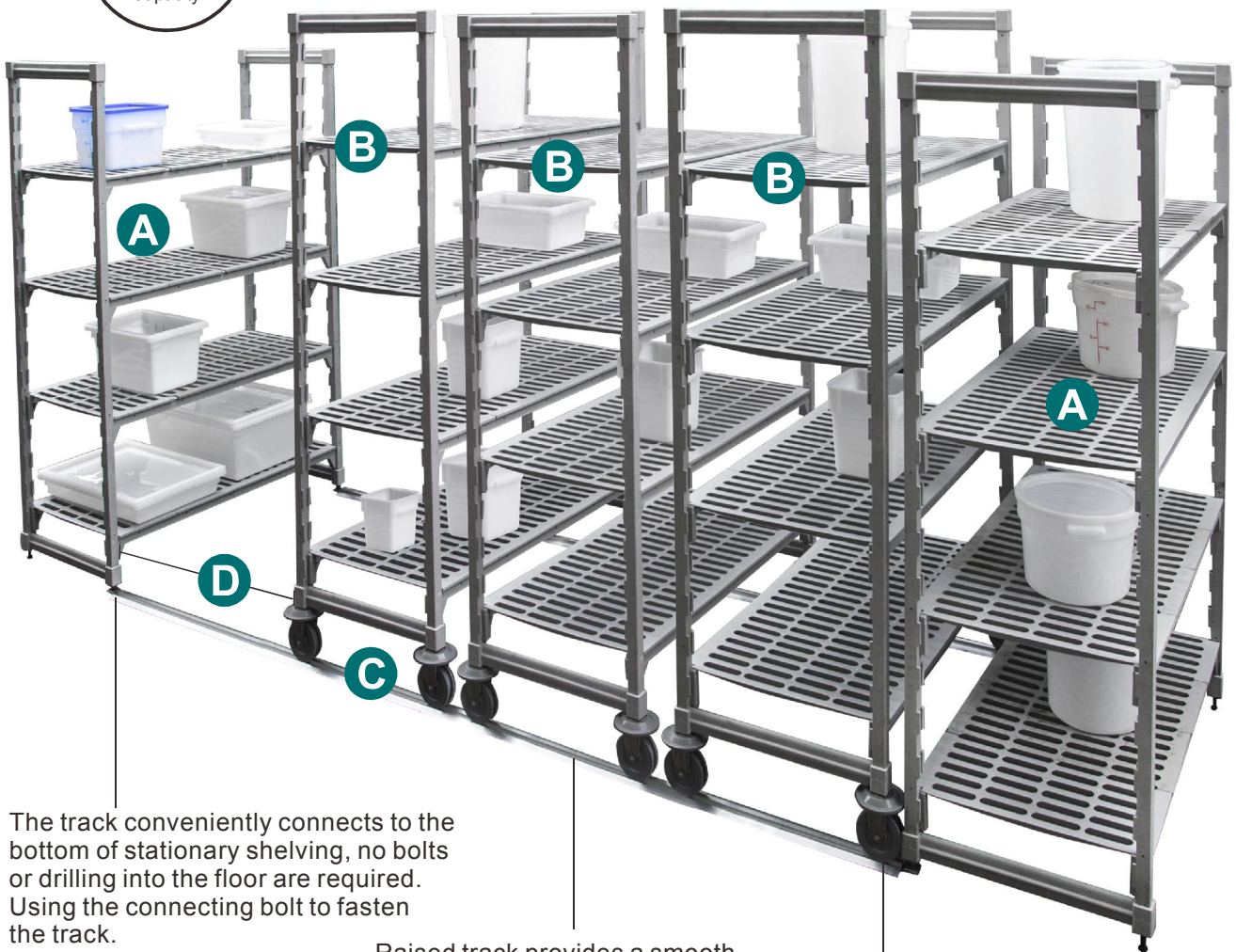

The track conveniently connects to the bottom of stationary shelving, no bolts or drilling into the floor are required. Using the connecting bolt to fasten the track.

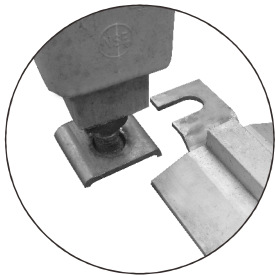

Raised track provides a smooth surface for mobile units. It ensures dirt will not get trapped, and is easy to clean. Shelves unit with heavy weight lands can roll smoothly on the track.

Grooved casters roll easily on raised track, which can be used on any surface. The caster with a bumper can provide protection.

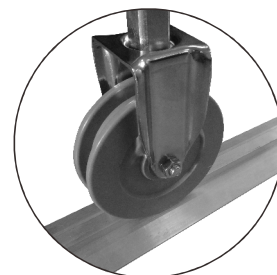

# High Density Mobile Shelving Storage System

## Caster

High Density Mobile Unit includes 4 High Density Casters with 4 High Density Donut Bumpers.

Weight bearing capacity of High Density Mobile Unit is 340kg. All necessary hardware is included in the track kit.

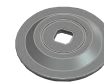

Art.No.	JW-HDC5	JW-HDDB5
Name	5" High Density Caster	5" High Density Bumper
Size	127mm / 5"	127mm / 5"

## Track



Art.No.	JW-GD3050	JW-GD3660	JW-GD4420
Name	3050mm track kit for 3 move units	3660mm track kit for 3 move units	4420mm track kit for 3 move units
Size	3050mm	3660mm	4420mm

## High Density Mobile Units 4 Vented Starter Units 72" **1880 mm**

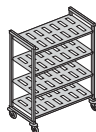

Width	Length	910 <sup>36"</sup> mm	1060 <sup>42"</sup> mm	1220 <sup>48"</sup> mm	1370 <sup>54"</sup> mm	1525 <sup>60"</sup> mm
530 <sup>21"</sup> mm	Art.No.	PSU362172M	PSU422172M	PSU482172M	PSU542172M	PSU602172M
	Weight/Cube	34.89/0.100	38.16/0.116	41.61/0.130	45.53/0.138	49.21/0.147
610 <sup>24"</sup> mm	Art.No.	PSU362472M	PSU422472M	PSU482472M	PSU542472M	PSU602472M
	Weight/Cube	35.72/0.107	39.61/0.117	42.72/0.140	47.24/0.160	51.64/0.161

## High Density Mobile Units 4 Solid Starter Units 72" **1880 mm**



Width	Length	910 <sup>36"</sup> mm	1060 <sup>42"</sup> mm	1220 <sup>48"</sup> mm	1370 <sup>54"</sup> mm	1525 <sup>60"</sup> mm
530 <sup>21"</sup> mm	Art.No.	PSS362172M	PSS422172M	PSS482172M	PSS542172M	PSS602172M
	Weight/Cube	34.96/0.100	38.24/0.116	41.84/0.130	45.72/0.138	49.63/0.147
610 <sup>24"</sup> mm	Art.No.	PSS362472M	PSS422472M	PSS482472M	PSS542472M	PSS602472M
	Weight/Cube	37.60/0.107	41.10/0.117	54.03/0.140	49.16/0.160	53.35/0.161

# Epoxy Wire Shelving

## Epoxy Wire Shelving

- Providing the ideal storage solution: epoxy mesh multiple sizes available.
- Open wire construction allows a free circulation of air.
- Open design allows greater visibility of stored items which is convenient to check.
- Different shapes are available based on different circumstance.
- Adjustable to various heights.
- Each shelf supports up to 250kgs, without casters.
- Color: blue, green, black, silver.

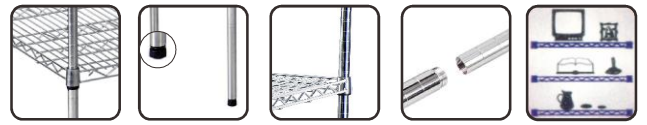

Assemble easily    Adjust simply    Adjust efficiently    Assemble easily    Use variously



### 1600mm Height

Art.No	Size LxWxH(mm)
EN241863	610X455X1600
EN301863	760X455X1600
EN361863	910X455X1600
EN421863	1060X455X1600
EN481863	1220X455X1600
EN541863	1370X455X1600
EN601863	1525X455X1600
EN721863	1825X455X1600
EN242163	610X530X1600
EN302163	760X530X1600
EN362163	910X530X1600
EN422163	1060X530X1600

Art.No	Size LxWxH(mm)
EN482163	1220X530X1600
EN542163	1370X530X1600
EN602163	1525X530X1600
EN722163	1825X530X1600
EN242463	610X610X1600
EN302463	760X610X1600
EN362463	910X610X1600
EN422463	1060X610X1600
EN482463	1220X610X1600
EN542463	1370X610X1600
EN602463	1525X610X1600
EN722463	1825X610X1600

Note: This item requires a MOQ.

### 1800mm Height

Art.No	Size LxWxH(mm)
EN241871	610X455X1800
EN301871	760X455X1800
EN361871	910X455X1800
EN421871	1060X455X1800
EN481871	1220X455X1800
EN541871	1370X455X1800
EN601871	1525X455X1800
EN721871	1825X455X1800
EN242171	610X530X1800
EN302171	760X530X1800
EN362171	910X530X1800
EN422171	1060X530X1800

Art.No	Size LxWxH(mm)
EN482171	1220X530X1800
EN542171	1370X530X1800
EN602171	1525X530X1800
EN722171	1825X530X1800
EN242471	610X610X1800
EN302471	760X610X1800
EN362471	910X610X1800
EN422471	1060X610X1800
EN482471	1220X610X1800
EN542471	1370X610X1800
EN602471	1525X610X1800
EN722471	1825X610X1800

# S/S Shelving / Chromed Shelving

## S/S Shelving / Chromed Shelving

- Providing the ideal storage solution; S/S/ Chromed mesh, multiple sizes available.
- Open wire construction allows a free circulation of air.
- Open design allows greater visibility of stored items which is convenient to check.
- Different shapes are available based on different circumstance.
- Adjustable to various heights easily.
- Each shelf supports up to 250kgs, without casters.

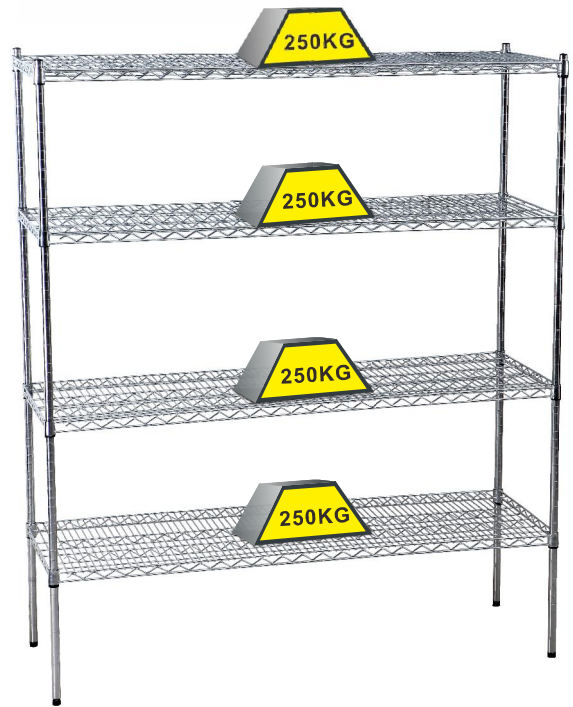

Assemble easily    Adjust simply    Adjust efficiently    Assemble easily    Use variously

# S/S Shelving / Chromed Shelving

## Caster



Art.No.	JW-5S	JW-5SC
Name	5" Universal Casters	5" Universal Casters With Brake
Size	127mm / 5"	127mm / 5"

## S/S Shelving

### 1600mm Height

Art.No	Size LxWxH(mm)
SN241863	610X455X1600
SN301863	760X455X1600
SN361863	910X455X1600
SN421863	1060X455X1600
SN481863	1220X455X1600
SN541863	1370X455X1600
SN601863	1525X455X1600
SN721863	1825X455X1600
SN242163	610X530X1600
SN302163	760X530X1600
SN362163	910X530X1600
SN422163	1060X530X1600

Art.No	Size LxWxH(mm)
SN482163	1220X530X1600
SN542163	1370X530X1600
SN602163	1525X530X1600
SN722163	1825X530X1600
SN242463	610X610X1600
SN302463	760X610X1600
SN362463	910X610X1600
SN422463	1060X610X1600
SN482463	1220X610X1600
SN542463	1370X610X1600
SN602463	1525X610X1600
SN722463	1825X610X1600

### 1800mm Height

Art.No	Size LxWxH(mm)
SN241871	610X455X1800
SN301871	760X455X1800
SN361871	910X455X1800
SN421871	1060X455X1800
SN481871	1220X455X1800
SN541871	1370X455X1800
SN601871	1525X455X1800
SN721871	1825X455X1800
SN242171	610X530X1800
SN302171	760X530X1800
SN362171	910X530X1800
SN422171	1060X530X1800

Art.No	Size LxWxH(mm)
SN482171	1220X530X1800
SN542171	1370X530X1800
SN602171	1525X530X1800
SN722171	1825X530X1800
SN242471	610X610X1800
SN302471	760X610X1800
SN362471	910X610X1800
SN422471	1060X610X1800
SN482471	1220X610X1800
SN542471	1370X610X1800
SN602471	1525X610X1800
SN722471	1825X610X1800

Note: "S2" added after above Art.No. is for S/S 201, "SS4" for S/S 304.  
Some sizes require a MOQ.

## Chromed Shelving

### 1600mm Height

Art.No	Size LxWxH(mm)
CN241863	610X455X1600
CN301863	760X455X1600
CN361863	910X455X1600
CN421863	1060X455X1600
CN481863	1220X455X1600
CN541863	1370X455X1600
CN601863	1525X455X1600
CN721863	1825X455X1600
CN242163	610X530X1600
CN302163	760X530X1600
CN362163	910X530X1600
CN422163	1060X530X1600

Art.No	Size LxWxH(mm)
CN482163	1220X530X1600
CN542163	1370X530X1600
CN602163	1525X530X1600
CN722163	1825X530X1600
CN242463	610X610X1600
CN302463	760X610X1600
CN362463	910X610X1600
CN422463	1060X610X1600
CN482463	1220X610X1600
CN542463	1370X610X1600
CN602463	1525X610X1600
CN722463	1825X610X1600

### 1800mm Height

Art.No	Size LxWxH(mm)
CN241871	610X455X1800
CN301871	760X455X1800
CN361871	910X455X1800
CN421871	1060X455X1800
CN481871	1220X455X1800
CN541871	1370X455X1800
CN601871	1525X455X1800
CN721871	1825X455X1800
CN242171	610X530X1800
CN302171	760X530X1800
CN362171	910X530X1800
CN422171	1060X530X1800

Art.No	Size LxWxH(mm)
CN482171	1220X530X1800
CN542171	1370X530X1800
CN602171	1525X530X1800
CN722171	1825X530X1800
CN242471	610X610X1800
CN302471	760X610X1800
CN362471	910X610X1800
CN422471	1060X610X1800
CN482471	1220X610X1800
CN542471	1370X610X1800
CN602471	1525X610X1800
CN722471	1825X610X1800

Note: Some sizes require a MOQ.

# Wine Storage Rack

## Wine Storage Rack

- Standard four-tier of 15" spacing distribution
- Each shelf equips with 4 stencils according to different sizes of bottles to separate different sizes of storage space.
- Grid structure ensures the flow of air which is helpful for temperature controlling.
- The sealed back and side panels can keep the bottles safe and prevent accidents.
- Front door with locks is for security.
- Two different sizes are available.

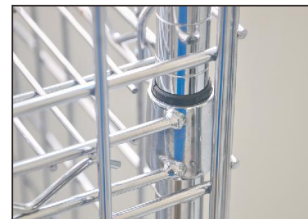
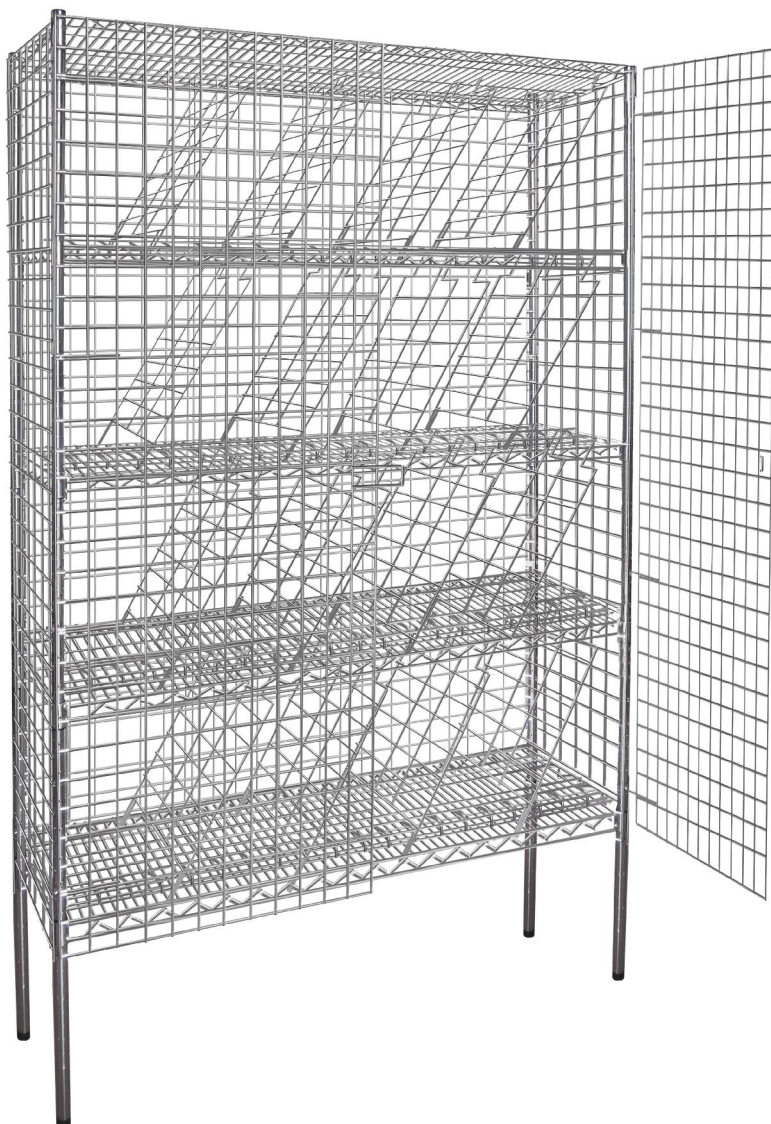

Exquisite Workmanship

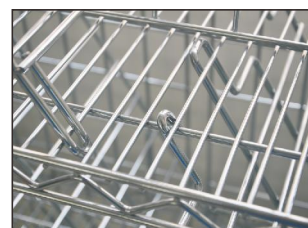

Movable & Foldable

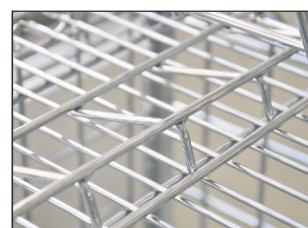

Maintain te 10° tilt up

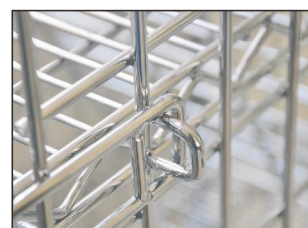

With safety lock

Art.No.	JW-WSS3614	JW-WSS4814	JW-WSC3614	JW-WSC4814
<b>Name</b>	910mm S/S Wine Storage Rack	1220mm S/S Wine Storage Rack	910mm Chromed Wine Storage Rack	1220mm Chromed Wine Storage Rack
<b>Size</b>	910x355x1900 mm	1220x355x1900 mm	910x355x1900 mm	1220x355x1900 mm
<b>Material</b>	S/S	S/S	Chromed	Chromed
<b>Carrying Capacity</b>	12 boxes	16 boxes	12 boxes	16 boxes
<b>PCS/CTN</b>	1	1	1	1

# Faucet Products



Mounted Faucet



Workboard Faucet



Pantry Faucets



Dipperwell Bowl



Wall Mounted Retractable  
Hose Reel



# Mounted Faucet

## Easy Install Pre-rinse Unit



JW-PS13B

**A**

### CARTRIDGES

Interchangeable  
Self-contained and easily replaced  
Ceramic and compression

**B**

### EASY INSTALL

Patented design  
Unique "pop-and lock" riser connection  
that takes as little as 10 minutes to install

**C**

### FAUCETS

Forged one-piece base faucet eliminated leaks  
Copper layer over casting makes smoother surface  
Thick chrome plating

**D**

### HOSES

Stainless steel hoses with double interlocked  
covers for long life  
Sealed ends prevent tears  
Vinyl nylon reinforced inner hose tested to  
1200PSL

**E**

### PACKAGING

Pre-assembled parts are ready for quick  
installation  
Fewer parts to misplace

**F**

### SPRING

Specially designed spring reinforced at  
the stress point where hose connects.  
Protects and extends life of hose

**G**

### SPRAY VALVES

Significant water-saving with low-flow  
rates  
Uncompromising performance  
Tested to over 1.5 million cycles

# Mounted Faucet



<b>Art.No.</b>	JW-PS13
<b>Ref.No</b>	B-0113
<b>Material</b>	Brass(Plastic)
<b>Notes</b>	Spare parts available
<b>PCS/CTN</b>	1

**4" Deck Mounted Faucet**



<b>Art.No.</b>	JW-PS38
<b>Ref.No</b>	B-2338
<b>Material</b>	Brass(Plastic)
<b>Notes</b>	Spare parts available
<b>PCS/CTN</b>	1

**4" Center Deck Faucet**



<b>Art.No.</b>	JW-PS33
<b>Ref.No</b>	B-0133
<b>Material</b>	Brass(Plastic)
<b>Notes</b>	Spare parts available
<b>PCS/CTN</b>	1

**8" Center Wall Mounted Faucet**



<b>Art.No.</b>	JW-PS18
<b>Ref.No</b>	B-0118
<b>Material</b>	Brass(Plastic)
<b>Notes</b>	Spare parts available
<b>PCS/CTN</b>	1

**8" Center Wall Faucet**

# Pot and Kettle Filler

## Pot and Kettle Filler

- Chrome plated brass faucets stainless steel hoses with hook outlets are available.
- Wall Mounted Pot and Kettle Filler has hot and cold taps 8" (203mm).
- Hook nozzle outlet with automatic self-generating valve and hook.
- 1/2" NPT female inlets.
- Built in check valves to prevent crossflow of water.
- Hold down ring for continuous flowing.

Art.No.	JW-PK05	JW-PK10
<b>Name</b>	Single Pot and Kettle Filler	8" Pot and Kettle Filler
<b>Ref.No</b>	B-0605	B-0610
<b>Material</b>	Brass(Plastic)	Brass(Plastic)
<b>Notes</b>	Spare parts available	Spare parts available
<b>PCS/CTN</b>	1	1



JW-PK05



JW-PK10

## Pot Filler Faucet

- 18" (457 mm) double joint nozzle
- Insulated on-off volume control grip on tip of nozzle
- Wall mounting hole I.D.: 25mm

Art.No.	JW-PF0592
<b>Name</b>	Pot Filler Faucet
<b>Material</b>	Brass(Plastic)
<b>Notes</b>	Spare parts available
<b>PCS/CTN</b>	1



JW-PF0592

# Wall Mounted Retractable Hose Reel



Art.No.	JW-GS03	JW-GS05	JW-GS06
<b>Name</b>	Economic Version Open Retractable Hose Reel	Open Retractable Hose Reel	Open S/S Retractable Hose Reel
<b>Tef.No.</b>	B-1403	B-7232-01	B-7132-01
<b>Length</b>	10.5 M	10.5 M	10.5 M
<b>Material</b>	Brass/Steel/Plastic	Brass/Steel/Plastic	Brass/Steel/Plastic
<b>Notes</b>	Spare parts available	Spare parts available	Spare parts available
<b>PCS/CTN</b>	1	1	1

# Workboard Faucet



JW-PS123

## **8" Deck-Mounted Workboard Faucet**

12" (305mm) swing nozzles  
1/2" standard pipe thread, removable seats,  
chrome plated escutcheon  
Deck mounting holes I.D.: 25mm X 2, 8" (203mm) center



JW-PS113

## **4" Deck-Mounted Workboard Faucet**

12" (305mm) swing nozzles  
1/2" standard pipe thread, removable seats,  
chrome plated escutcheon  
Deck mounting holes I.D.: 25mm X 2, 4" (102mm) center



JW-PS142

## **8" Deck-Mounted Workboard Faucet**

Swing gooseneck with 5-11/16" (145mm) spread  
1/2" standard pipe thread, removable seats,  
chrome plated escutcheon  
Deck mounting holes I.D.: 25mm X 2, 8" (203mm) center



JW-PS141

## **4" Deck-Mounted Workboard Faucet**

Swing gooseneck with 5-11/16" (145mm) spread  
1/2" standard pipe thread, removable seats,  
chrome plated escutcheon  
Deck mounting holes I.D.: 25mm X 2, 4" (102mm) center



JW-PS132

## **8" Deck-Mounted Workboard Faucet**

18" (457mm) double-joint nozzles  
1/2" standard pipe thread, removable seats,  
chrome plated escutcheon  
Deck mounting holes I.D.: 25mm X 2, 8" (203mm) center



JW-PS131

## **4" Deck-Mounted Workboard Faucet**

18" (457mm) double-joint nozzles  
1/2" standard pipe thread, removable seats,  
chrome plated escutcheon  
Deck mounting holes I.D.: 25mm X 2, 4" (102mm) center

# Pantry Faucets



**JW-PS221**  
**8" Deck-Mounted Mixing Faucet**

Double pantry faucet with 12" (305mm) swing nozzle  
8" (203mm) centers, lever handles  
1/2" standard pipe thread, eccentric flanged  
Deck mounting holes I.D.: 25mmX2, 8" (203mm) center



**JW-PS225**  
**4" Deck-Mounted Mixing Faucet**

Double pantry faucet with 12" (305mm) swing nozzle  
4" (102mm) centers, lever handles  
1/2" standard pipe thread, eccentric flanged  
Deck mounting holes I.D.: 25mmX2, 4" (102mm) center



**JW-PS321**  
**8" Deck-Mounted Mixing Faucet**

Swing gooseneck with 5-11/16" (145mm) spread  
8" (203mm) centers, lever handles  
1/2" standard pipe thread, eccentric flanged  
Deck mounting holes I.D.: 25mmX2, 8" (203mm) center



**JW-PS325**  
**4" Deck-Mounted Mixing Faucet**

Swing gooseneck with 5-11/16" (145mm) spread  
4" (102mm) centers, lever handles  
1/2" standard pipe thread, eccentric flanged  
Deck mounting holes I.D.: 25mmX2, 4" (102mm) center



**JW-PS245**  
**8" Deck-Mounted Mixing Faucet**

18" (457mm) double-joint nozzles  
8" (203mm) centers, lever handles  
1/2" standard pipe thread, eccentric flanged  
Deck mounting holes I.D.: 25mmX2, 8" (203mm) center



**JW-PS248**  
**4" Deck-Mounted Mixing Faucet**

18" (457mm) double-joint nozzles  
4" (102mm) centers, lever handles  
1/2" standard pipe thread, eccentric flanged  
Deck mounting holes I.D.: 25mmX2, 4" (102mm) center

# Pantry Faucets



**JW-PS201**  
**4" Deck-Mounted Double Mixing Faucet**

12" (305mm) swing nozzle  
Single hole base faucet with 4" (102mm) spreader unit  
Lever handles, nut and tailpiece furnished for optional 1/4" standard pipe thread connections  
Deck mounting holes I.D.: 35mm



**JW-PS206**  
**Deck-Mounted Single Pantry Faucet**

12" (305mm) swing nozzle  
Lever handle (specify hot or cold)  
1/2" standard pipe thread male shank  
Deck mounting holes I.D.: 25mm



**JW-PS301**  
**4" Deck-Mounted Double Mixing Faucet**

5-11/16" (145mm) swing gooseneck  
Single hole base faucet with 4" (102mm) spreader unit  
Lever handles, nut and tailpiece furnished for optional 1/4" standard pipe thread connections  
Deck mounting holes I.D.: 35mm



**JW-PS306**  
**Deck-Mounted Single Pantry Faucet**

5-11/16" (145mm) swing gooseneck  
Lever handle (specify hot or cold)  
1/2" standard pipe thread male shank  
Deck mounting holes I.D.: 25mm



**JW-PS250**  
**4" Deck-Mounted Double Mixing Faucet**

18" (457mm) double-joint nozzles  
Single hole base faucet with 4" (102mm) spreader unit  
Lever handles, nut and tailpiece furnished for optional 1/4" standard pipe thread connections  
Deck mounting holes I.D.: 35mm



**JW-PS255**  
**Deck-Mounted Single Pantry Faucet**

18" (457mm) double-joint nozzles  
Lever handle (specify hot or cold)  
1/2" standard pipe thread male shank  
Deck mounting holes I.D.: 25mm

# Workboard and Pantry Faucets

According to user demand,  
matching of different base  
faucets and nozzles





JW-PS110-LN  
Workboard Faucet



JW-PS120-LN  
Workboard Faucet

Deck mounted  
Forged brass body  
Removable seats  
6-1/2"(165mm) long,  
2"(51mm) wide chrome  
plated escutcheon  
4"(102mm) centers

Deck mounted  
Forged brass body  
Removable seats  
10-1/2"(267mm) long,  
2"(51mm) wide chrome  
plated escutcheon  
8"(203mm) centers

NOZZLES	MODEL	L/SIZE	MODEL	MODEL
	JW-PS-021	8" (203mm)	—	—
<b>Swing Nozzle</b>	JW-PS-016	12" (305mm)	JW-PS113	JW-PS123
	JW-PS-020	后长度:6"(152mm) 前长度:12"(305mm) 总长度:18"(457mm)	JW-PS131	JW-PS132
<b>Swivel-Joint Nozzle</b>				
	JW-PS-019	5-11/16" (145mm)	JW-PS141	JW-PS142
<b>Swivel Gooseneck</b>				





**JW-PS220-LN**  
**Swivel Base Faucet**



**JW-PS225-LN**  
**Swivel Base Faucet**



**JW-PS200-LN**  
**Swivel Base Faucet**



**JW-PS205-LN**  
**Single Pantry Faucet**



**JW-PS210-LN**  
**Swivel Base Faucet**

Deck mixing faucet-swivel  
Lever handles  
8"(203 mm) centers

Deck mixing faucet-swivel  
Lever handles  
4"(102 mm) centers

Deck mixing faucet,  
deck-mounted  
Lever handles  
Deck mounting-hole:35mm

Single pantry faucet,  
deck-mounted  
Lever handle  
(specify cold or hot)  
Deck mounting-hole:25mm

Deck mounted mixing faucet  
Lever handle  
(specify cold or hot)  
Wall mounting-hole:25mm

MODEL	MODEL	MODEL	MODEL	MODEL
JW-PS220	—	—	—	—
JW-PS221	JW-PS225	JW-PS201	JW-PS206	JW-PS211
JW-PS245	JW-PS248	JW-PS250	JW-PS255	JW-PS260
JW-PS321	JW-PS325	JW-PS301	JW-PS306	—

# Dipperwell Bowl and Faucet / Waste Valves



## JW-DB2282 Dipperwell Bowl and Faucet

Includes Dipperwell Bowl and Faucet  
Deck mounting hole I.D.: 22mm,  
146mm. Attention the clearance  
between faucet and bowl.



## JW-WV3952-01 Waste Valve and overflow Assembly

"-01" models include an overflow assembly,  
Handle length: 312mm  
Product length: 720mm, height: 430mm



## JW-DB2282-01 Dipperwell Faucet

5" (168 mm) overall height  
1-3/8" (35 mm) above table  
1/16" (1.6 mm) solder inlet  
Deck mounting hole I.D.: 22mm



## JW-DB2282-02 Dipperwell Bowl

Keeps ice cream scoops and paddles clean and  
sanitized,  
Stainless steel internal cup, outer container and  
tail washer,  
4" (102 mm) length of 1-1/2" (38 mm) brass tubing,  
Sits flush with tabletop,  
Drains quickly and easily,



## JW-WV3952 Twist Waste Valves

Twist rotary waste valves  
Drain adapter  
Valve bodies come standard with 2" outlet  
3-1/2" (89 mm) sink opening applications

# Faucets Accessories



JW-PS-001  
Flex S/Hose



JW-PS-002  
Spring overhead



JW-PS-003  
Spray Valve



JW-PS-004  
Add-on Faucet Unit



JW-PS-005  
Wall Monut



JW-PS-006  
Deck Mount



JW-PS-007  
12-Inch Wall Bracket



JW-PS-008  
Button Valve



JW-PS-009  
Cold Water Valve



JW-PS-010  
Hot Water Valve



JW-PS-011  
Valve Handle (Hot)



JW-PS-012  
Valve Handle (Cold)



JW-PS-013  
Pre-Rise Spray Head



JW-PS-014  
Pre-Rise Spray Supply Inlet



JW-PS-015  
Faucet Valve



JW-PS-016  
Neck of Faucet Unit



JW-PS-017  
Straight Brass Tube



JW-PS-018  
S Shape Handle



# Drink Server

## Drink Server

- Keep beverage hot or cold and fresh for hours.
- Suitable for the restaurant's foreground and background.
- Seamless double-wall PP construction and foamed-in-place polyurethane insulation ensures years of reliable service and prevents liquids from seeping walls.
- Molded-in mounting plates prevent latches from pulling out.
- Drip-proof recessed spigot allows for easy accessing and can be easily adjusted without tools.
- Wide service opening accommodates larger cup or coffee pots when units are stacked on a riser.
- Each unit includes a set of beverage label.
- Interlocking construction allows for stable stacking and space saving.

Materia: PE,PU  
Colour: Brown



**Vent caps**  
Balanced pressure makes the container easily open.



**Recessed faucet**  
Accommodates for larger cups, Two positions, one for continuous pouring. And the other for individual dispensing.



**1 inch ultra latch**  
With durable plastic ultra latch. It won't rust. Suitable for JW-INC7L, JW-INC9.4L, JW-INC18L.



**9.5 inch ultra latch**  
Wide nylon latches are rust free and easy to open and close by one hand. Suitable for JW-INC44.5L.

## Insulation Effect

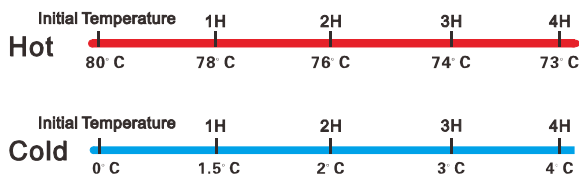

Art.No.	JW-INC7L	JW-INC9.4L	JW-INC18L	JW-INC44.5L
<b>Name</b>	7L Insulated Container	9.4L Insulated Container	18L Insulated Container	44.5L Insulated Container
<b>Size</b>	420x230x420 mm	420x230x470 mm	420x230x620 mm	530x415x630 mm
<b>Pigot</b>	YES	YES	YES	YES
<b>Capacity</b>	7L	9.4L	18L	44.5L
<b>PCS/CTN</b>	1	1	1	1

## Accessories Available



Art.No.	JW-RIS1	JW-RIS2
<b>Name</b>	Riser1	Riser2
<b>Size</b>	415x230x120 mm	495x390x115 mm
<b>Colour</b>	Brown	Brown
<b>PCS/CTN</b>	1	1

Note: JW-RIS1 Suitable for JW-INC7L, JW-INC9.4L, JW-INC18L  
JW-RIS2 Suitable for JW-INC44.5L

# EPP Insulated Pan Carrier

## EPP Insulated Pan Carrier

- It can hold more than GN1/1 pan.
- Made of EPP material, sturdy, light and durable
- Great structural strength, capable of handling significant loads while maintaining its shape and form.
- With good insulation and heat resistance, it can withstand temperature from  $-40^{\circ}\text{C}$  to  $+120^{\circ}\text{C}$ .
- Ideal to store hot and cold food safely for hours
- Clean, sealed, 100% recyclable.

## Insulation Effect

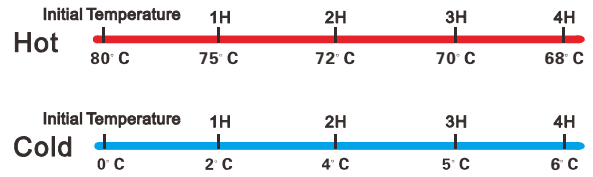

**$-40^{\circ}\text{C}$  to  $120^{\circ}\text{C}$**



Art.No.	JW-CD2516	JW-EPP160	JW-EPP180	JW-EPP400
<b>Name</b>	EPP Insulated Pan Carrier Cart	EPP160 Insulated Pan Carrier	EPP180 Insulated Pan Carrier	EPP400 Insulated Pan Carrier
<b>Outer Size</b>	647x427x205 mm	600x400x260 mm	600x400x317 mm	640x435x630 mm
<b>Inter Size</b>	/	535x335x195 mm	535x335x252 mm	535x335x525 mm
<b>Colour</b>	Black+Silver	Black	Black	Black
<b>Weight</b>	4.1 kg	1.2 kg	1.3 kg	4.5 kg
<b>PCS/CTN</b>	1	1	1	1

# EPP Insulated Pan Carrier

## Insulated Pan Carrier Placement effect diagram

**JW-EPP160**  
Store GN1/1  
Capacity

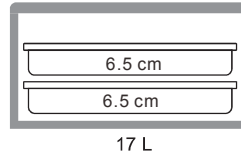
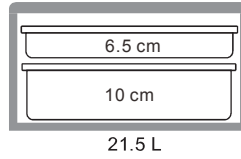
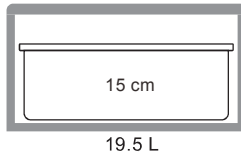

**JW-EPP180**  
Store GN1/1  
Capacity

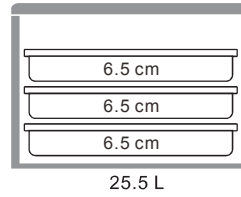
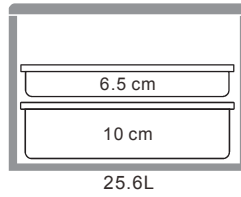
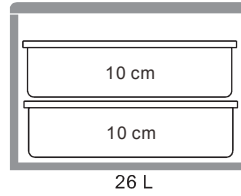
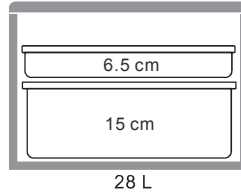
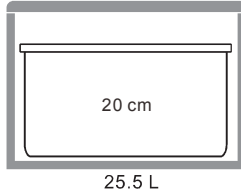

## Insulated Pan Carrier Placement effect diagram

**JW-EPP400**  
Store GN1/1  
Capacity

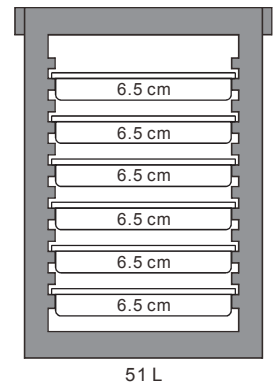
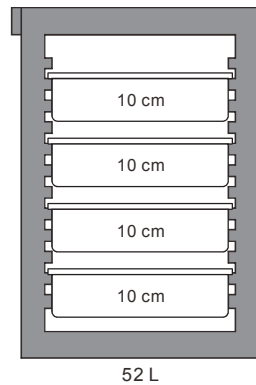
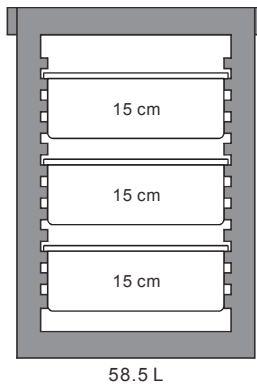
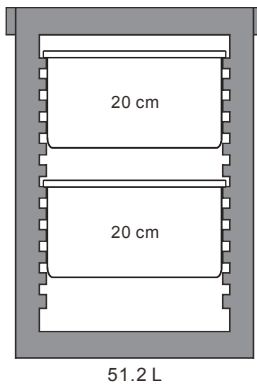

## Features



Sealing slot design helps to maintain temperature for a longer time.



Can be stacked easily



Can store GN1/1 PAN



Inside label area for label placing



The built-in handle is convenient for grasping from four sides and easy to handle.



With guide track design, can hold 2-6pcs 1/1 GN pans



Declining edge helps easy door opening and closing

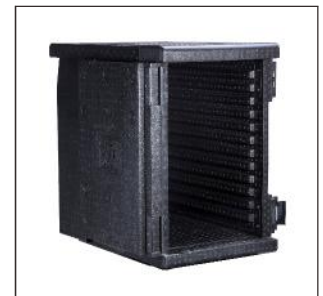

270° Open door

# Insulated Food Servers



## Insulated Food Servers

- It can hold food pans in sizes of 1/1, 1/2. With seamless PE construction, thick foam material, tenacious padlock and a dismountable airtight gasket, it can preserve food heated for several hours without external power supply.
- A vent cap can balance pressure and help easy opening.
- Non-slip handles make it easier to be carried.
- A durable nylon latch will never get rust.

Materia: PE,PU  
 Colour: Grey

### Insulation Effect

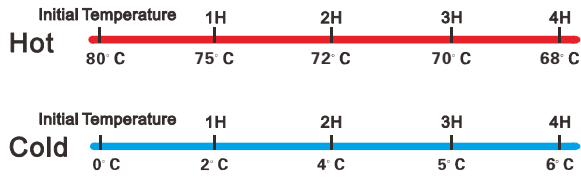

### Accessories Available



Art.No.	JW-FOC
Name	Ultra Carts
Size	710x530x230 mm
Colour	Grey
PCS/CTN	1

Note: JW-FOC Suitable for JW-SIF, JW-SIN



Art.No.	JW-SIF	JW-SIN	JW-DOW
Name	Ultra Carts For Food Pan	Ultra Carts For Food Pan	Double For Food Carries
Outer Size	477x680x620 mm	477x680x620 mm	508x700x1200 mm
Inter Size	335x533x495 mm	335x533x495 mm	335x533x420 mm (Double)
GN1/1 Height 6.5cm	6PCS	6PCS	10PCS
GN1/1 Height 10cm	4PCS	4PCS	6PCS
GN1/1 Height 15cm	3PCS	3PCS	4PCS
GN1/1 Height 20cm	2PCS	2PCS	4PCS
PCS/CTN	1	1	1



# Insulated Pan / Sliding Ice Caddy



## Insulated Pan

- Used to store and transport hot or cold food.
- Thick foam material can preserve food heat for several hours without external power supply.
- A vent cap can balance pressure and help easy opening.
- Boxes can be interlocked and stacked up for better transporting and for saving space.
- Boxes can be taken out through notches.
- Easy to be cleaned up.

Materia: PE,PU  
Colour: Grey

### Insulation Effect

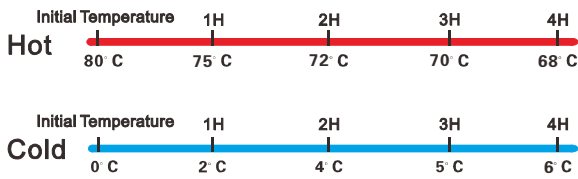

Art.No.	JW-INF100H	JW-INF150H	JW-INF200H
<b>Name</b>	Insulated Pan	Insulated Pan	Insulated Pan
<b>Outer Size</b>	630x440x210 mm	630x440x260 mm	630x440x305 mm
<b>Compartment Capacity</b>	1 GN1/1-100mm 2 GN1/2-100mm	1 GN1/1-150mm 2 GN1/2-150mm	1 GN1/1-200mm 2 GN1/2-200mm
<b>Accompany With Carts</b>	JW-FOC	JW-FOC	JW-FOC
<b>PCS/CTN</b>	1	1	1



## Sliding Ice Caddy

- The caddy stores ices and keeps ices from melting.
- Thick foam construction helps better preservation.
- The sliding lid helps to reduce cross contamination.
- The water tank and a drain shelf separate water and ices, prolonging storage time.
- The ergonomically designed handles make transporting easy.
- Installation is needed.

Materia: PE,PU  
Colour: Grey

Art.No.	JW-SLI
<b>Name</b>	Sliding Ice Caddy
<b>Outer Size</b>	585x800x745 mm
<b>Capacity</b>	110L
<b>Weight Capacity(ice)</b>	57KG
<b>PCS/CTN</b>	1





# Mobile Plate Rack

## Plate Rack For 12/48 Plates

- 48/84 plate mobile plate rack and 12/48-plate floor-standing plate rack are the most innovative, the most widely used plate rack at present.
- Can hold trays, dishes and flat plates.
- Can be adjusted to any size.
- Separating columns and rubber granules are made of soft copolymer resin, and this can protect plates from breaking.
- The separated design provides strong support and stability.
- 4" non-trace casters with brake of 48/84-plate rack are non-slip and resistant to oil and water, standing with higher stability and security.
- The rubber bottom granules of 12/48- plate rack can stick to the floor, standing more stably.
- With strict sanitary inspection, all materials are environmental-friendly, durable and will do no harm.



Art.No.	JW-DC12B	JW-DC48B
<b>Name</b>	Plate Rack For 12 Plates	Plate Rack For 48 Plates
<b>Outer Size</b>	350x350x460 mm	545x545x1080 mm
<b>Axis Width</b>	245 mm	245 mm
<b>Max Width</b>	350 mm	560 mm
<b>PCS/CTN</b>	1	1

## Mobile Plate Rack

- Can be used to store 40/80 plates.
- Can easily move plates soonest to storage or banquet areas.
- High-quality swivel caster care for stability.
- Save space and efficient working.

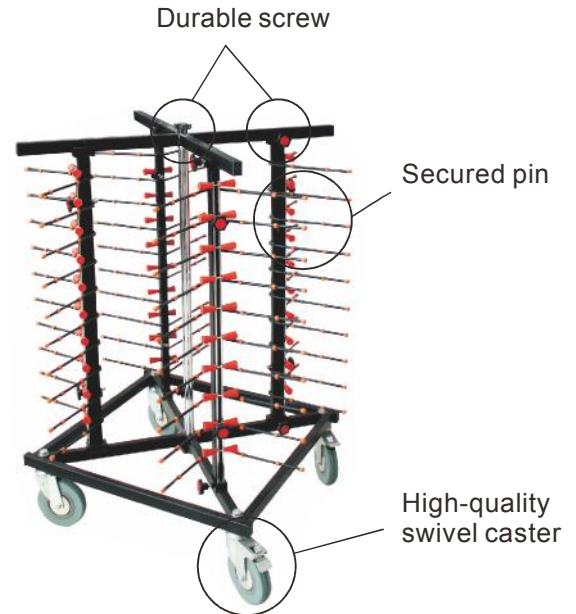

Vinyl Cover included for sanitary storage.



Art.No.	JW-DC48	JW-DC84	JW-DC40	JW-DC80
<b>Name</b>	Mobile Plate Rack For 48 Plates	Mobile Plate Rack For 84 Plates	Mobile Plate Rack For 40 Plates	Mobile Plate Rack For 80 Plates
<b>Outer Size</b>	730x730x1260 mm	730x730x1910 mm	575x575x1003 mm	575x575x1790 mm
<b>Axis Width</b>	245 mm	245 mm	790 mm	790 mm
<b>Max Width</b>	600 mm	675 mm	575 mm	575 mm
<b>Vinyl Cover</b>	JW-VC48	JW-VC84	JW-VC40	JW-VC80
<b>PCS/CTN</b>	1	1	1	1

Note: Vinyl cover needs to buy separately.

# Adjustable Dish Caddy

## Adjustable Dish Caddy

- Streamlined design, PE dividing columns can prevent damages.
- Arcuate corners can protect using place from damages.
- Non-slip handles make easy moving.
- The dividers are adjustable.



JW-DC320

DC320 can hold 4.5"-13" plates, trays and dishes. Maximum 6 dividers, 8 stacks, and 400 pcs.



JW-DC160

DC160 can hold 4.5"-13" plates, trays and dishes. Maximum 4 dividers, 4 stacks, and 200 pcs.



JW-DC240

DC240 can hold 4.5"-13" plates, trays and dishes. Maximum 6 dividers, 6 stacks, and 300 pcs.

Art.No.	JW-DC320	JW-DC240	JW-DC160
Name	Adjustable Dish Caddy	Adjustable Dish Caddy	Adjustable Dish Caddy
Size	1090x720x800 mm	930x720x800mm	900x725x800 mm
Material	PE	PE	PE
Colour	Brown	Brown	Brown
PCS/CTN	1	1	1

# Adjustable Dish Caddy

## JW-DC320



DC320 Layout for 10" by 14-1/2" trays and 7-1/2" to 10" plates

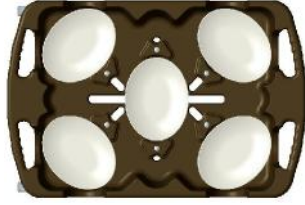

DC320 Layout for 12" by 9-1/4" and 9-1/2" by 7-1/4" plates



DC320 Layout for 9-4/5" to 11-1/4" plates



DC320 Layout for 8" to 8-1/4" plates

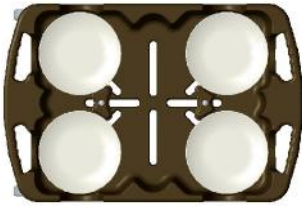

DC320 Layout for 11-2/5" to 13" plates and 13-1/2" by 10-1/2" plates

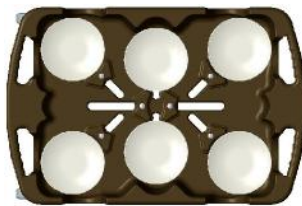

DC320 Layout for 8-2/5" to 8-4/5" plates



DC320 Layout for 12" by 9" to 9-1/2" by 7-1/4" plates, 4-1/2" to 8" plates and 5-1/2" to 12" plates"

## JW-DC240



DC240 Layout for 7" to 9" plates and 5-1/2" to 7" and 4-1/2" plate



DC240 Layout for 9" to 13" plates



DC240 Layout for 7" to 9" plates



DC240 Layout for 5-1/2" to 7" plates



DC240 Layout for 9" to 13" plates and 5" plates



DC240 Layout for 7" to 9" plates and 4-1/2" plates

## JW-DC160



DC160 layout for 6" to 13" plates



DC160 layout for 4-1/2" to 6" plates

# Wall Mount Plate Rack

## Wall Mount Plate Rack

- Flexible usage, lower labor cost, fast delivery, efficient work.
- Separating columns and rubber granules are made of soft copolymer resin, and this can protect plates from breaking and collapsing.
- The separated design provides much more support and stability.
- Holds 6-21 plates.
- Take dinner plates off counter.



Art.No.	JW-WM21	JW-WM18	JW-WM12	JW-WM9	JW-WM6
<b>Name</b>	Wall Mount Plate Rack For 21 Plates	Wall Mount Plate Rack For 18 Plates	Wall Mount Plate Rack For 12 Plates	Wall Mount Plate Rack For 9 Plates	Wall Mount Plate Rack For 6 Plates
<b>Outer Size</b>	120x100x1625 mm	120x100x1425 mm	120x100x1015 mm	120x100x810 mm	120x100x575 mm
<b>Hold Plates Quantity</b>	21 PCS	18 PCS	12 PCS	9 PCS	6 PCS
<b>PCS/CTN</b>	1	1	1	1	1

# 26 Sheet Pan Rack

## 26 Sheet Pan Rack

- Sideboards can fix food pans.
- Ergonomically designed handle can be easily controlled with safety.
- The top and the bottom are made from plastics of industrial hardness.
- Easy to clean up. The sideboards are made of chromium alloy, anti-collision and anti-corrosion.
- Protective anti-collision devices can reduce scratches and collisions.
- It can support food pans in size of 18" x 26"
- Bearing Capacity: 150KG

**Protective bumpers**  
Plastic rounded design helps to wrap sideboards tightly, avoiding scratches

**User-friendly handles**  
Can easily move in working area

**Locking Bar System**  
Locking bar can fix the pans and improve security when move.

**Pan holder**  
Hold the pans from the base to enhance the security



JW-PRC



Art.No.	JW-PR26	JW-PRC	JW-PR261B
<b>Name</b>	26 Sheet Pan Rack	Cover For Sheet Pan Rack	Pan
<b>Size</b>	758x585x1750 mm	700x590x1550 mm	660x460x30 mm
<b>Weight Capacity</b>	130 kg	/	1.32 kg
<b>Colour</b>	Black	Clear	Black
<b>Material</b>	S/S/Chrome/PP	PVC	Aluminum
<b>PCS/CTN</b>	1	1	9

# Tray Table Ware Cart

## Tray Table Ware Cart

- Designed to carry trays.
- Trays and accessories can be put inside the cart .
- Eight compartments on the top can place food pans to store tablewares, napkins and bagged seasonings.

Material: PE  
Colour: Brown  
Remark: Cart with vinyl cover

<b>Art.No.</b>	<b>JW-TRT</b>
<b>Name</b>	Tray Table Ware Cart
<b>Size</b>	820x540x1160 mm
<b>Weight Capacity</b>	100 kg
<b>Tray Capacity</b>	180–200PCS ( IN two stacks )
<b>Maximum Tray Size</b>	360x460 mm
<b>PCS/CTN</b>	1

## Food Pan Quantity

<b>Food Pan Quantity / Size</b>	<b>Capacity</b>
4 GN1/3 x 10 CM Height	It contains 100 knives, 100 spoons and 80 forks.
4 GN1/6 x 10 CM Height	It can accommodate various bags of seasoning.





# Multiduty Service Cart

## Multiduty Service Cart

- Light and flexible, ideal for hotels, restaurants and bars.
- Can be used to collect and carry food or table wares in room service.
- PP material is environmental, sanitary, durable and easy to be cleaned.
- Three-tier design provides enough space for storage.
- Bear capacity: 120 KG
- With more convenient open top layer.
- Ergonomically designed handle can be comfortably and flexibly used.
- Optional with half open and full open.



Art.No.	JW-SED	JW-SEDO
<b>Name</b>	Multiduty Service Cart	Open Multiduty Service Cart
<b>Outer Size</b>	980x530x930 mm	980x530x930 mm
<b>Comp.Size</b>	800x530x300 mm	800x530x300 mm
<b>Colour</b>	Black	Black
<b>Weight</b>	19.3 kg	14.9 kg
<b>Material</b>	PP	PP
<b>PCS/CTN</b>	1	1



Art.No.	JW-PSC14	JW-PSC19	JW-PSC22	JW-PSC26	JW-SH9	JW-TC30
<b>Name</b>	14L Debris Disc	19L Debris Disc	22L Debris Disc	26L Debris Disc	9L Tableware Box	30L Trash Can
<b>Size</b>	515x379x126 mm	574x404x122 mm	528x386x176 mm	567x431x176 mm	330x230x178 mm	330x230x560 mm
<b>Capacity</b>	14L	19.2L	22.6L	26.2L	9L	30L
<b>Weight</b>	830g	1100g	1080g	1270g	620g	1535g
<b>Material</b>	PP	PP	PP	PP	PP	PP
<b>PCS/CTN</b>	12	12	12	12	6	6

# Collapsible Laundry Cart

## Collapsible Laundry Cart

- Compact, light, and collapsible. It enable efficient storage.
- With large capacity, durable and reusable.
- Detachable, easy to clean up.
- Black lacquer covers up stains and dirt.
- High-quality TPR casters move quietly.
- Synthetic rubber straps help to prevent damage.



Solid material and excellent spraying process make no wrap or rust.



JW-XC150



Swivel casters are with superior maneuverability, meanwhile, synthetic rubber straps can provide additional protection while moving.



Compact, collapsible frame reduces width by 75% to enable efficient storage.



JW-XC300M



JW-XC300

Sheets, clothes or garbage can be collected with two 150L high capacity vinyl bags. Sorted collection saves costs and improves efficiency.

Art.No.	JW-XC150	JW-XC300	JW-XC300M	JW-RB150	JW-RB300
<b>Name</b>	150L Collapsible Laundry Cart	300L Collapsible Laundry Cart	300L Multistream Collapsible Laundry Cart	150L High-Capacity Vinyl Bag	300L High-Capacity Vinyl Bag
<b>Description</b>	With a 150L high-capacity vinyl bag	With a 300L high-capacity vinyl bag	With two 300L high-capacity vinyl bag		
<b>Size</b>	660x495x860 mm	895x660x860 mm	895x660x860 mm	355x560x750 mm	730x560x750 mm
<b>Capacity</b>	150L	300L	300L	150L	300L
<b>Colour</b>	Black	Black	Black	Black	Black
<b>Material</b>	Powder Coated	Powder Coated	Powder Coated	Vinyl	Vinyl
<b>PCS/CTN</b>	1	1	1	1	1

# Folding Cart

## Folding Cart

- Widely used in all kinds of restaurants and hotels.
- Thick stainless steel material structure, frosted surface, beautiful and durable.
- Buckle design, faster and simply folding or unfolding the cart.
- Folding storage can reduce the area of 50%.
- Ergonomic handle design, comfortable operation.
- 4" universal silent wheels, of which two with brakes; Safe and quiet.
- Bear capacity: 150KG.



Easily holds with one hand!



Art.No.	JW-FC2115	JW-FC3021
<b>Name</b>	Small Folding Cart	Big Folding Cart
<b>Size</b>	420x760x900 mm	520x990x900 mm
<b>Colour</b>	Black	Black
<b>Weight</b>	13.1 kg	17.6 kg
<b>PCS/CTN</b>	1	1

# Heavy-duty Platform Trucks

## Heavy-duty Platform Trucks

- Unique Mute. transmission design makes it move silently and smoothly.
- It's novel and beautiful. Strips added on surface can effectively avoid sliding.
- It's suitable for hotel & restaurant transport, and other transport of goods.
- Foldable handle.
- Bear 300KG.



<b>Art.No.</b>	<b>JW-HD3624</b>
<b>Name</b>	Heavy-duty Platform Trucks
<b>Size</b>	903x605x860 mm
<b>Colour</b>	Grey
<b>Weight</b>	16.0 kg
<b>PCS/CTN</b>	1





# Dinner Chair

## Dinner Chair

- The design has taken a full consideration of the capacity and stability.
- The matched tray can be used conveniently. It can be taken down with one hand. Two colors are optional.
- Chairs can be stacked, saving storage place.

Meets the ASTM F404-16 safety standards



JW-D1

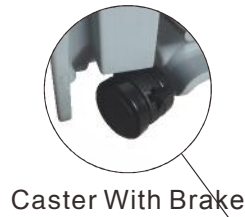

Caster With Brake



JW-D

Patent No.: 201020026959.X

Art.No.	JW-D	JW-D1
<b>Name</b>	Dinner Chair	Tray
<b>Size</b>	590x640x740 mm	367x476x72 mm
<b>Weight Capacity</b>	60 kg	/
<b>Colour</b>	Grey/Black	Grey/Black
<b>Material</b>	PP	PP
<b>PCS/CTN</b>	1	1

## Baby Chair

- The curve shape seat can keep the child comfortable at meals.
- Double sides with different heights can be chosen.
- Safety belts are matched to both sides to enhance the safety.

Art.No.	JW-B
<b>Name</b>	Baby Chair
<b>Size</b>	316x311x238 mm
<b>Inside Seat A</b>	210x244x90 mm
<b>Inside Seat B</b>	273x273x120 mm
<b>Colour</b>	Black/Coffee
<b>Material</b>	PE
<b>PCS/CTN</b>	1





JIWINS®



JIWINS®  
MADE IN CHINA

# Compact Cleaning Cart

## Compact Cleaning Cart

- Aesthetically designed suitable to be used in the lobby.
- Innovative model of tool management & storage.
- With novel design, excellent efficiency and beautiful shape, it can be used to clean & collect light garbage.
- Compact design helps for easier operation and better observation.
- Advanced bidirectional opening lids help to increase working efficiency.



Equipped with a 10-quart disinfection pail



Rubber tools holder can fix cleaning tools.

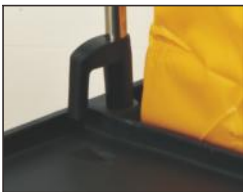

The hook can fix mop buckets with different sizes, preventing the buckets from falling over



Swivel casters offer better mobility in work area

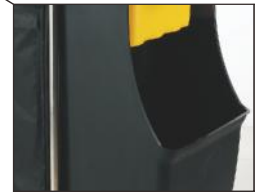

Storage cabinet (34L/9-gallon)



Optional with a 32-gallon recycle round container (JW-CR120E)



Optional with two 20-gallon recycle containers (JW-CR76S)



Storage platform for mop bucket



Simplified Compact Cleaning Cart (JW-CCSS)

Art.No.	Name	Description	Size	Weight	PCS/CTN
JW-CCS	Compact Cleaning Cart	Equipped with 19 gal of recycling bag(bk) Equipped with 9 gal of storage cabinet Equipped with a 10 QT disinfection-pail(JW-DP10)	1260x575x975 mm	15.8 kg	1
JW-CCSS	Simplified Compact Cleaning Cart	Equipped with 19 gal of recycling bag(bk) Equipped with a 10 QT disinfection-pail(JW-DP10)	1095x575x975 mm	12.8 kg	1



# Cleaning Cart Series

## Luxury Compact Cleaning Cart

Two recyclable bags make it easier to collect and sort garbage.



Optional with a 20-gallon Recyclable container (JW-CR76S)



Simplified Luxury Compact Cleaning Cart (JW-CCLS)



JW-CCL

Art.No.	Name	Description	Size	Weight	PCS/CTN
JW-CCL	Luxury Compact Cleaning Cart	Equipped with two 19 gal of recycling bags (BK) Equipped with one 9 gal cabinet Equipped with one 10 quart disinfection pail(JW-DP10)	1260x575x975 mm	19.3 kg	1
JW-CCLS	Simplified Luxury Compact Cleaning Cart	Equipped with two 19 gal of recycling bags (BK) Equipped with one 10 quart disinfection pail(JW-DP10)	1095x575x975 mm	15.0 kg	1

## Multifunctional Cleaning Cart

Made of rustless aluminum and solid plastic. With a non-slip and comfortable handle, two 4" swivle and two 8" directional casters. Easy to clean up.

- Storage platform for mop bucket.
- Collapsible platform for disinfection pail.
- Tools can be stored in innovative rubber holders on both sides at any position of the handles.
- Optional with two 10-quart disinfection pails, each can carry six sprayers.
- Optional with two 30-quart storage barrels that can be installed on both sides of the cart.



JW-CCMD

Art.No.	Name	Description	Size	Weight	PCS/CTN
JW-CCMD	Multifunctional Cleaning Cart	Equipped with a 30 gal high-capacity vinyl bag.(YL)	1212x575x115 mm	19.8 kg	1

# Cleaning Cart Series

## High Capacity Cleaning Cart

- With high capacity, flexible. It's a one-stop and tidy tools.
- Optional with two 10-quart disinfection pails, each can carry six sprayers.
- Optional with two 30-quart storage barrels that can be installed on both sides of the cart
- Optional with 20 gallons waste container.



JW-SB30



JW-CCHD

Art.No.	Name	Description	Size	Weight	PCS/CTN
JW-CCHD	High Capacity Cleaning Cart	Equipped with two 30 gal high-capacity vinyl bags.(YL)	1300x575x1115 mm	21.1 kg	1

## Triple Capacity Cleaning Cart

Triple capacity cleaning cart helps to save costs, increase working efficiency, and sort garbage quickly.

- Rubber holders can help hold the tools in the cart
- Made of rustless aluminum and solid plastics
- With two 4" swivel casters and two stable 8" directional casters



Optional with two 10-quart disinfection pails



With two 8" silent casters



Optional with three 30-quart yellow vinyl bags



Optional with three 30-quart black vinyl bags



Art.No.	Name	Description	Size	Weight	PCS/CTN
JW-CCTD	Triple Capacity Cleaning Cart	Equipped with three 30 gal high-capacity vinyl bags.(RD/GN/BU)	1300x575x1115 mm	19.1 kg	1



A storage box can be used as a cover of the garbage bin.



Security cover with lock.

## Innovative Cleaning Cart

- Fully meet the requirement of micro fiber cleaning.
- Tools can be stored in innovative rubber holders on both sides at any position of handles.
- Optional with two 30-quart storage barrels that can be installed on both sides of the cart.
- Optional with two 10-quart disinfection pails, each one can carry 6 sprayers.
- Optional with 20 gal recycling containers.



Platform for storing mobile mop buckets.



Collapsible platform for disinfection pails.



Art.No.	Name	Description	Size	Weight	PCS/CTN
JW-CCID	Innovative Cleaning Cart	Two doors with lock.(on both sides of the cart) Equipped with a 30 gal high-capacity vinyl bag.(YL)	1212x575x1115 mm	29.1 kg	1

# Cleaning Cart Series

## Luxury Cleaning Cart

- Fully meet the requirement of micro fiber cleaning.
- Tools can be stored in innovative rubber holders on both sides at any position of handles.
- Optional with two 30-quart storage barrels that can be installed on both sides of the cart.
- Optional with two 10-quart disinfection pails, each one can carry 6 sprayers.
- Optional with 20 gallon recycling containers.



A retractable handle can save space



Platform for storage mobile mop buckets



Art.No.	Name	Description	Size	Weight	PCS/CTN
JW-CCED	Luxury Cleaning Cart	Two doors with lock (On both sides of the cart) Equipped with a storage box and a security cover with lock Equipped with a 30 gallons high-capacity vinyl bags	1212x575x1320 mm	33.6 kg	1

## Medical Places Special Cleaning Cart

Match the requirement of Joint Commission on Accreditation of Healthcare Organizations (JACHO); Standard storage cabinet with lock, security cover with lock and a storage box.

- With a lock, it is safer.
- Platform for storing mobile mop buckets.
- Collapsible platform for disinfection pails.
- Optional with 20 gallon recycling container.
- Tools can be stored in innovative rubber holders on both sides at any position of the handles.



Art.No.	Name	Description	Size	Weight	PCS/CTN
JW-CCMS	Medical Places Special Cleaning Cart	Two doors with lock. (On both sides of the cart) Equipped with two storage boxes and a security cover with lock. Equipped with two 30 gallons high-capacity vinyl bags.(YL)	1300x575x1320 mm	35.7 kg	1

# Accessories



Art.No.	Name	Size	Weight	PCS/CTN
JW-DP10	10 QT Disinfecting pail	355x207x195 mm	0.65 kg	6
JW-SB34	34 QT Organizing Bins	415x335x275 mm	1.2 kg	6
JW-SB30	30 QT Organizing Bins	454x362x278 mm	1.5 kg	6
JW-MP32	32L Mop Buckets	540x380x900 mm	7.3 kg	1
JW-CR76S	20 Gal Recycling Container(76L)	510x275x760 mm	3.0 kg	6
JW-CR120E	32 Gal Recycling Container(121L)	Φ557x693 mm	4.0 kg	6
JW-FS	Floor Sign	298x20x62 mm	0.6 kg	10
JW-CCDL	30 Gal High-Capacity Vinyl Bag (Red/Blue/Green/Yellow/Black Multifunctional Cleaning Cart )	400x330x850 mm	0.7 kg	24
JW-CCCB	19 Gal Recycling Bag (Yellow/Black Compact Cleaning Cart)	380x260x720 mm	0.7 kg	24
JW-CCSB	Storage Box	460x280x60 mm	0.9 kg	6
JW-CCSH	Security Compartment	425x460x235 mm	2.2 kg	1
JW-VB76D	Doors with Lock	400x66x800 mm	8.6 kg	2

# Housekeeping Cart

## Housekeeping Cart

- The surface is easy to clean up.
- The cart is with quiet design and will leave no mark when moving. Two casters are with brake.
- Standard equipment includes plastic bags, anti-collision devices, a vacuum storage rack and a bottom shelf.
- Large capacity cabinet can provide spacious storage space with an adjustable middle shelf.
- Ergonomically designed handle is easy to grab and control.
- An easy-control dust cover is in the upper part.
- Used to deliver food, goods and garbage in the hotel



**Storage Bag**  
It can effectively collect and transfer towels or other items. Optional with black and yellow.

JW-HCC1

**Goods Storage Rack**  
It can store a basket and other small items, saving storage space.



Optional with a pocket organizer caddy bag.

JW-9P

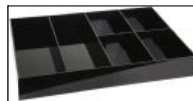

The top divider of housekeeping cart.  
JW-HCCR



JW-HCD2

**Plastic Door With Lock**  
Plastic door with a lock is safe and high-end.



JW-HCF3

**Protective cover**  
The rolling door type top cover can slide from front or back. It's convenient to use and can save storage space.

Art.No.	Name	Size	Colour	Material	Weight Capacity	PCS/CTN
JW-HCC1	Standard Housekeeping Cart	1536x554x1252 mm	Black	PP	120 kg	1
JW-HCD2	Standard Housekeeping Cart	1536x554x1252 mm	Black	PP	120 kg	1
JW-HCF3	Luxury Housekeeping Cart	1536x554x1510 mm	Black	PP	120 kg	1
JW-HCCR	The top divider of housekeeping cart	620x480x65 mm	Black	PMMA	/	1
JW-9P	9-Pocket Organizer Caddy Bag for Housekeeping Cart	700x430 mm	Black	Vinyl	/	1

# Step-on Container

## Step-on Container

- Designed to avoid touching garbage.
- The sealed lid can prevent odor from spilling.
- Tough, puncture-resistant, all-plastic construction won't rust or damage.
- Heavy pedal for hands-free use, avoiding cross infection.
- Material; HDPE&PP.
- Colour: Beige.



The inner barrel can be taken out to be cleaned and used alone.



The lid can be opened by stepping on the pedal according to the Lever Principle.



Art.NO.	Name	Size	Capacity	PCS/CTN
JW-CPT30	30.3L Step-on Container	480x380x440 mm	30.3L/8Gal.	4
JW-CPT45	45.5L Step-on Container	400x380x600 mm	45.4L/12Gal.	3
JW-CPT68	68.1L Step-on Container	500x400x670 mm	68.1L/18Gal.	3
JW-CPT87	87.1L Step-on Container	500x400x840 mm	87.1L/23Gal.	2
JW-CPT30W	30.3L Step-on Container without Inner Barrel	480x380x440 mm	30.3L/8Gal.	4
JW-CPT45W	45.5L Step-on Container without Inner Barrel	400x380x600 mm	45.4L/12Gal.	3
JW-CPT68W	68.1L Step-on Container without Inner Barrel	500x400x670 mm	68.1L/18Gal.	3
JW-CPT87W	87.1L Step-on Container without Inner Barrel	500x400x840 mm	87.1L/23Gal.	2

## Optional



JW-CIB30



JW-CIB45



JW-CIB68



JW-CIB87

Art.NO.	Name	Size	Capacity	PCS/CTN
JW-CIB30	30.3L Inner Barrel	354x288x350 mm	Inner Barrel Is Optional	6
JW-CIB45	45.5L Inner Barrel	354x288x516 mm	Inner Barrel Is Optional	6
JW-CIB68	68.1L Inner Barrel	453x300x574 mm	Inner Barrel Is Optional	6
JW-CIB87	87.1L Inner Barrel	453x300x736 mm	Inner Barrel Is Optional	6

# Recycling Slim Container

## Recycling Slim Container

- With interchangeable and different color coded lids for better garbage classification.
- Blue lid with rectangular hole for paper waster.
- Green lid with two round holes for glass bottles, jars and metal cans.
- Grey handle lid for common waster.



Paper Lid

Handle Lid

Bottle & Can Lid

## Slim Container Dolly

- For easy transportation.
- One compartment and two compartment dolly can make up three or four compartment dolly. It's convenient for classify garbage with different lids.
- Three or four compartment dolly are made up through connecting with buckles.



JW-SD2312

JW-DD2324

## Recycling Slim Container

Art.No.	Name	Size	Colour	Material	Weight	PCS/CTN
JW-CR76S	Recycling Slim Container	509x281x760 mm	Gray/Blue/Black	PE	3.5 kg	6

## Lid For Recycling Slim Container

Art.No.	Name	Size	Colour	Material	Weight	PCS/CTN
JW-CRPL	Paper Lid	516x290x93 mm	Blue	PP	0.4 kg	6
JW-CRHL	Handle Lid	516x290x93 mm	Grey	PP	0.4 kg	6
JW-CRBL	Bottle & Can Lid	516x290x93 mm	Green	PP	0.4 kg	6

## Dolly For Recycling Slim Container

Art.No.	Name	Size	Colour	Material	Weight	PCS/CTN
JW-SD2312	Single Compartment Dolly	580x309x195 mm	Black	PP	2.1 kg	1
JW-DD2324	Double Compartment Dolly	580x610x195 mm	Black	PP	3.6 kg	1



# Vented Channel Container

## Vented Channel Container

- With a unique design, cross-ventilation is created inside and this makes easier dumping.
- The buckles fasten the garbage bags
- Handles on both sides make easier job.
- It can be conveniently transported with a dolly.



Ventilated design saves 60% pull out strength



The buckles fasten the garbage bags. Handles on both sides make easier job.



The bottom design helps effective emptying.



JW-CRSL

**Swing Lid**  
With two self-righting highest, it can be make cleaner garbage disposal.



JW-CRHC

**Hinged Cover**  
With a drain tank, ideal for outdoor use.

Art.No.	Name	Size	Colour	Material	Weight	PCS/CTN
JW-CR76V	Vented Channel Container	566x279x760 mm	Grey	PE	3.3 kg	6
JW-CRHC	Hinged Cover	518x357x64 mm	Black	PP	0.8 kg	6
JW-CRSL	Swing Lid	557x297x140 mm	Black	PP	2.5 kg	6

# Recycle Round Container



## Recycle Round Container

- Never rust, concave and peel off.
- The sealed lid makes no leakage.
- Strengthened edge makes it more durable .
- Well-designed handles make easier and more comfortable work .
- Double surrounding edges at the bottom improve the stability and enhance the dragging force .
- Easy, fast and flexible transporting.
- Five swivel casters make easy control.
- Convenient assembly and disassembly.



Five swivel casters make easy control.



Snap-lock sealed lid prevents odors from spilling out, and it keeps surroundings clean.



Solid-built handles design makes easy lifting.



Pedal control makes easy disassembly.



Art.NO.	Name	Size	Capacity	PCS/CTN
JW-CR38E	37.9L Recycle Round Container	Φ398x434 mm	37.9L/10Gal.	12
JW-CR76E	75.7L Recycle Round Container	Φ492x584 mm	75.7L/20Gal.	12
JW-CR120E	121.1L Recycle Round Container	Φ557x693 mm	121.1L/32Gal.	6
JW-CR170E	166.5L Recycle Round Container	Φ617x794 mm	166.5L/44Gal.	6
JW-CR210E	208.2L Recycle Round Container	Φ679x840 mm	208.2L/55Gal.	6
JW-RCD	Dolly For Recycle Round Container	Φ460x164 mm	/	2

Note: JW-RCD Dolly can be used for JW-CR76E、JW-CR120E、JW-CR170E、JW-CR210E.

## Lid For Recycle Round Container

Art.NO.	Name	Size	Suitable	PCS/CTN
JW-CRC1P	Lid For Recycle Round Container	Φ410x28 mm	JW-CR38E	24
JW-CRC2P	Lid For Recycle Round Container	Φ500x40 mm	JW-CR76E	12
JW-CRC3P	Lid For Recycle Round Container	Φ570x38 mm	JW-CR120E	12
JW-CRC4P	Lid For Recycle Round Container	Φ633x38 mm	JW-CR170E	12
JW-CRC5P	Lid For Recycle Round Container	Φ690x49 mm	JW-CR210E	12



## Cleaning Tool



Art.No.	JW-FRW8	JW-FRW13
<b>Name</b>	8L Fire Resistant Wastebaskets	13L Fire Resistant Wastebaskets
<b>Size</b>	240x168x265 mm	275x210x315 mm
<b>PCS/CTN</b>	20	20



Art.No.	JW-CTB1015	JW-CTH-4	JW-WGS/JW-SHB
<b>Name</b>	Multifunctional Carry Caddy	Cleaning Tool Holder	Upright Dust Pan With Cover
<b>Size</b>	386x275x170 mm	462x55x60 mm	/
<b>PCS/CTN</b>	6	24	12



## Hotel & Kitchen Utensil



<b>Art.No.</b>	<b>JW-PF1.5</b>	<b>JW-CBS40302</b>	<b>JW-CBS40303</b>	<b>JW-CBS50352</b>
<b>Name</b>	Cup Holder Clip	Rectangle Cutting Board	Rectangle Cutting Board	Rectangle Cutting Board
<b>Size</b>	63x36x16 mm	400x300x20 mm	400x300x25 mm	500x360x20 mm
<b>PCS/CTN</b>	480	6	6	6



<b>Art.No.</b>	<b>JW-CBS50353</b>	<b>JW-CBS60402</b>	<b>JW-CBS60403</b>	<b>JW-CBS60405</b>	<b>JW-CBR455</b>
<b>Name</b>	Rectangle Cutting Board	Rectangle Cutting Board	Rectangle Cutting Board	Rectangle Cutting Board	Round Cutting Board
<b>Size</b>	500x360x25 mm	600x400x20 mm	600x400x25 mm	600x400x50 mm	Φ450x50 mm
<b>PCS/CTN</b>	6	6	6	2	2



<b>Art.No.</b>	<b>JW-GWB3</b>	<b>JW-GWB2</b>	<b>JW-GWB1</b>
<b>Name</b>	Triple Glass Washers	Triple Glass Washers	Triple Glass Washers
<b>Size</b>	185x85x190 mm	185x85x255 mm	185x85x255 mm
<b>PCS/CTN</b>	12	12	12

# Product Index

Art.No	Page	Art.No	Page	Art.No	Page	Art.No	Page
CN241863	67	EN242163	65	JW-1009A	26	JW-1513C	29
CN241871	67	EN242171	65	JW-1009C	26	JW-1514A	29
CN242163	67	EN242463	65	JW-1010A	26	JW-1514C	29
CN242171	67	EN242471	65	JW-1010C	26	JW-1515A	29
CN242463	67	EN301863	65	JW-1012A	26	JW-1515C	29
CN242471	67	EN301871	65	JW-1012C	26	JW-1518A	29
CN301863	67	EN302163	65	JW-1014A	26	JW-1518C	29
CN301871	67	EN302171	65	JW-1014C	26	JW-16	5
CN302163	67	EN302463	65	JW-1016A	26	JW-1611A	29
CN302171	67	EN302471	65	JW-1016C	26	JW-1611C	29
CN302463	67	EN361863	65	JW-1017	7	JW-1613A	29
CN302471	67	EN361871	65	JW-102	7	JW-1613C	29
CN361863	67	EN362163	65	JW-1020A	26	JW-1615A	29
CN361871	67	EN362171	65	JW-1020C	26	JW-1615C	29
CN362163	67	EN362463	65	JW-103	7	JW-1615C	30
CN362171	67	EN362471	65	JW-100A	40	JW-1616A	29
CN362463	67	EN421863	65	JW-100P	40	JW-1616C	29
CN362471	67	EN421871	65	JW-10RA	40	JW-1618A	29
CN421863	67	EN422163	65	JW-10RP	40	JW-1618C	29
CN421871	67	EN422171	65	JW-1110P	27	JW-162	5
CN422163	67	EN422463	65	JW-1113P	27	JW-1708A	30
CN422171	67	EN422471	65	JW-110A	40	JW-1708C	30
CN422463	67	EN481863	65	JW-110P	40	JW-1710A	30
CN422471	67	EN481871	65	JW-1216A	27	JW-1710C	30
CN481863	67	EN482163	65	JW-1216C	27	JW-1711A	30
CN481871	67	EN482171	65	JW-1220A	27	JW-1711C	30
CN482163	67	EN482463	65	JW-1220C	27	JW-1712A	30
CN482171	67	EN482471	65	JW-120A	40	JW-1712C	30
CN482463	67	EN541863	65	JW-12OP	40	JW-1713A	30
CN482471	67	EN541871	65	JW-12RA	40	JW-1713C	30
CN541863	67	EN542163	65	JW-12RP	40	JW-1714A	30
CN541871	67	EN542171	65	JW-1308A	29	JW-1714C	30
CN542163	67	EN542463	65	JW-1308C	29	JW-172	7
CN542171	67	EN542471	65	JW-1310A	29	JW-173	7
CN542463	67	EN601863	65	JW-1310C	29	JW-1812C	30
CN542471	67	EN601871	65	JW-1311A	29	JW-1813C	30
CN601863	67	EN602163	65	JW-1311C	29	JW-1820C	30
CN601871	67	EN602171	65	JW-1312A	29	JW-20	6
CN602163	67	EN602463	65	JW-1312C	29	JW-2005A	26
CN602171	67	EN602471	65	JW-1314A	29	JW-2005C	26
CN602463	67	EN721863	65	JW-1314C	29	JW-2008A	26
CN602471	67	EN721871	65	JW-1411A	30	JW-2008C	26
CN721863	67	EN722163	65	JW-1411C	30	JW-2010A	26
CN721871	67	EN722171	65	JW-140A	40	JW-2010C	26
CN722163	67	EN722463	65	JW-14OP	40	JW-2012A	26
CN722171	67	EN722471	65	JW-14RA	40	JW-2012C	26
CN722463	67	JW-1006A	26	JW-14RP	40	JW-2014A	26
CN722471	67	JW-1006C	26	JW-1512A	29	JW-2014C	26
EN241863	65	JW-1008A	26	JW-1512C	29	JW-2016A	26
EN241871	65	JW-1008C	26	JW-1513A	29	JW-2016C	26

# Product Index

Art.No	Page	Art.No	Page	Art.No	Page	Art.No	Page
JW-2022A	26	JW-5050C	28	JW-8RP	40	JW-BS	44
JW-2022C	26	JW-5080A	28	JW-9	5	JW-BSK	41
JW-2103C	31	JW-5080C	28	JW-9010A	29	JW-BSNP1	43
JW-2105C	31	JW-5095A	28	JW-9010C	29	JW-BSP0.5	42
JW-2111C	31	JW-5095C	28	JW-9011A	29	JW-BSP1	42
JW-2115C	31	JW-5120A	28	JW-9011C	29	JW-BSP2	42
JW-2120A	26	JW-5120C	28	JW-9012A	29	JW-BSP2.5	42
JW-2120C	26	JW-5160A	28	JW-9012C	29	JW-BSS	41
JW-2205C	31	JW-5160C	28	JW-9013A	29	JW-BSW	41
JW-2206C	31	JW-601	45	JW-9013C	29	JW-BV	43
JW-2207C	31	JW-602	45	JW-92	5	JW-BW	44
JW-2313A	30	JW-603	45	JW-9P	107	JW-C	6
JW-2313C	30	JW-604C	45	JW-9RA	40	JW-C1310	12
JW-25	5	JW-6050A	28	JW-9RP	40	JW-C2113	12
JW-252	5	JW-6050C	28	JW-A1014A	32	JW-CBR455	113
JW-25B	7	JW-605C	45	JW-A1014P	32	JW-CBS40302	113
JW-25P	7	JW-606C	45	JW-A1216A	32	JW-CBS40303	113
JW-3008A	27	JW-607C	45	JW-A1216P	32	JW-CBS50352	113
JW-3008C	27	JW-6080A	28	JW-A1218A	32	JW-CBS50353	113
JW-3010A	27	JW-6080C	28	JW-A1218P	32	JW-CBS60402	113
JW-3010C	27	JW-608C	45	JW-A1418A	32	JW-CBS60405	113
JW-3012A	27	JW-609	45	JW-A1418P	32	JW-CCCB	106
JW-3012C	27	JW-6095A	28	JW-B	99	JW-CCDL	106
JW-3014A	27	JW-6095C	28	JW-B1115A	32	JW-CCED	105
JW-3014C	27	JW-610	45	JW-B1115P	32	JW-CCHD	103
JW-3015A	27	JW-6120A	28	JW-B3B	43	JW-CCID	104
JW-3015C	27	JW-6120C	28	JW-B4B	43	JW-CCL	102
JW-3022A	27	JW-6160A	28	JW-B5B	43	JW-CCLS	102
JW-3022C	27	JW-6160C	28	JW-B6B	43	JW-CCMD	102
JW-36	6	JW-6210A	28	JW-BA	44	JW-CCMS	105
JW-362	6	JW-6210C	28	JW-BB	44	JW-CCS	101
JW-4006A	26	JW-6310A	28	JW-BC	41	JW-CCSB	106
JW-4006C	26	JW-6310C	28	JW-BC2	41	JW-CCSH	106
JW-4008A	26	JW-64B	7	JW-BFB	44	JW-CCSS	101
JW-4008C	26	JW-64I	6	JW-BFG	44	JW-CCTD	103
JW-4009A	26	JW-64P	7	JW-BFW	44	JW-CD2516	83
JW-4009C	26	JW-7009A	28	JW-BG	44	JW-CIB30	108
JW-4010A	26	JW-7009C	28	JW-BH	44	JW-CIB45	108
JW-4010C	26	JW-7011A	28	JW-BMC	41	JW-CIB87	108
JW-4011A	26	JW-7011C	28	JW-BMQ	41	JW-CIN68	108
JW-4011C	26	JW-7016A	28	JW-BMT	41	JW-CJ250	37
JW-4012A	26	JW-7016C	28	JW-BMT52	41	JW-CPT30	108
JW-4012C	26	JW-7024A	28	JW-BN3	43	JW-CPT30W	108
JW-4015A	26	JW-7024C	28	JW-BN6D	43	JW-CPT45	108
JW-4015C	26	JW-8011P	27	JW-BN6L	43	JW-CPT45W	108
JW-49	6	JW-8013P	27	JW-BNN	41	JW-CPT68	108
JW-492	6	JW-8016P	27	JW-BO	43	JW-CPT68W	108
JW-4C	8	JW-8B	7	JW-BP	44	JW-CPT87	108
JW-501	44	JW-8BH	7	JW-BPP	44	JW-CPT87W	108
JW-5050A	28	JW-8RA	40	JW-BR	44	JW-CR120E	111

# Product Index

Art.No	Page	Art.No	Page	Art.No	Page	Art.No	Page
JW-CR120W	22	JW-DP10	106	JW-INF150H	86	JW-P14DS	12
JW-CR170E	111	JW-E1218A	32	JW-INF200H	86	JW-P14FC	11
JW-CR210E	111	JW-E1218P	32	JW-LBSD12	42	JW-P14HC	11
JW-CR38E	111	JW-EPP160	83	JW-LBSD24	42	JW-P14HH	11
JW-CR38W	22	JW-EPP180	83	JW-LBSD32	42	JW-P14SL	11
JW-CR76E	111	JW-EPP400	83	JW-LBSD8	42	JW-P162	12
JW-CR76S	109	JW-FC2115	96	JW-LC46	42	JW-P164	12
JW-CR76V	110	JW-FC3021	96	JW-MC20	41	JW-P166	12
JW-CR76W	22	JW-FCC	8	JW-MC40	41	JW-P16DS	12
JW-CRBL	109	JW-FCR	8	JW-MP32	106	JW-P16FC	11
JW-CRC1P	111	JW-FCS	106	JW-MTP50	19	JW-P16FL	11
JW-CRC1P(WHITE)	22	JW-FCS	8	JW-MTP55	19	JW-P16FLN	11
JW-CRC2P	111	JW-FHR	8	JW-MTP60	19	JW-P16HC	11
JW-CRC2P(WHITE)	22	JW-FIFO12	42	JW-MTP65	19	JW-P16HH	11
JW-CRC3P	111	JW-FIFO16	42	JW-MTP80	19	JW-P16SL	11
JW-CRC3P(WHITE)	22	JW-FIFO20	42	JW-P	8	JW-P192	12
JW-CRC4P	111	JW-FIFO24	42	JW-P112	12	JW-P194	12
JW-CRC5P	111	JW-FIFO32	42	JW-P114	12	JW-P19HC	11
JW-CRCS120	22	JW-FOC	85	JW-P116	12	JW-P19HH	11
JW-CRCS38	22	JW-FP	44	JW-P118	12	JW-P19SL	11
JW-CRCS76	22	JW-FPP	44	JW-P11DS	12	JW-P216	12
JW-CRHC	110	JW-FRC	8	JW-P11FC	11	JW-P218	12
JW-CRHL	109	JW-FRS	8	JW-P11HC	11	JW-P21FC	11
JW-CRPL	109	JW-FRW13	112	JW-P11HH	11	JW-P24HC	11
JW-CRSL	110	JW-FRW8	112	JW-P11SL	11	JW-PF0592	72
JW-CTB1015	112	JW-GBM	41	JW-P122	12	JW-PF1.5	113
JW-CTH-4	112	JW-GRC	8	JW-P124	12	JW-PK05	72
JW-D	99	JW-GS03	73	JW-P126	12	JW-PK10	72
JW-D1	99	JW-GS05	73	JW-P128	12	JW-PR26	92
JW-D1217A	32	JW-GS06	73	JW-P12DS	12	JW-PRC	92
JW-D1217P	32	JW-GSM	41	JW-P12FC	11	JW-PS113	74
JW-DB18263	21	JW-GWB1	113	JW-P12FL	11	JW-PS123	74
JW-DB18266	21	JW-GWB2	113	JW-P12FLN	11	JW-PS13	71
JW-DB20	19	JW-GWB3	113	JW-P12HC	11	JW-PS131	74
JW-DB2282	79	JW-HC46	42	JW-P12HH	11	JW-PS132	74
JW-DB2282-01	79	JW-HCC1	107	JW-P12SL	11	JW-PS13B	70
JW-DB2282-02	79	JW-HCCR	107	JW-P132	12	JW-PS141	74
JW-DBC1826	21	JW-HCD2	107	JW-P134	12	JW-PS142	74
JW-DC12B	88	JW-HCF3	107	JW-P136	12	JW-PS18	71
JW-DC160	89	JW-HD3624	97	JW-P138	12	JW-PS201	76
JW-DC240	89	JW-I001	45	JW-P13DS	12	JW-PS206	76
JW-DC320	89	JW-I002	45	JW-P13FC	11	JW-PS211	78
JW-DC40	88	JW-I003	45	JW-P13FL	11	JW-PS221	75
JW-DC46	42	JW-I004	45	JW-P13FLN	11	JW-PS225	75
JW-DC48	88	JW-I005	45	JW-P13HC	11	JW-PS245	75
JW-DC48B	88	JW-INC18L	82	JW-P13HH	11	JW-PS248	75
JW-DC80	88	JW-INC44.5L	82	JW-P13SL	11	JW-PS250	76
JW-DC84	88	JW-INC7L	82	JW-P142	12	JW-PS255	76
JW-DD2324	109	JW-INC9.4L	82	JW-P144	12	JW-PS260	78
JW-DOW	85	JW-INF100H	86	JW-P146	12	JW-PS301	76

# Product Index

Art.No	Page	Art.No	Page	Art.No	Page	Art.No	Page
JW-PS306	76	JW-SB34	106	JW-SL43214	50	JW-SL60252	37
JW-PS321	75	JW-SC106	43	JW-SL43251	50	JW-SL60253	37
JW-PS325	75	JW-SC110	43	JW-SL43252	50	JW-SL60254	37
JW-PS33	71	JW-SC76	43	JW-SL43253	50	JW-SL71141	37
JW-PS38	71	JW-SD2313	109	JW-SL43254	50	JW-SL71142	37
JW-PSC14	94	JW-SED	94	JW-SL50141	50	JW-SL71143	37
JW-PSC19	94	JW-SEDO	94	JW-SL50142	50	JW-SL71144	37
JW-PSC22	94	JW-SH9	94	JW-SL50143	50	JW-SL71181	37
JW-PSC26	94	JW-SHB	112	JW-SL50144	50	JW-SL71182	37
JW-R1014CT	33	JW-SIF	85	JW-SL50181	50	JW-SL71183	37
JW-R1014P	33	JW-SIN	85	JW-SL50182	50	JW-SL71184	37
JW-R1100CT	33	JW-SK280C	37	JW-SL50183	50	JW-SL71211	50
JW-R1100P	33	JW-SK280D	37	JW-SL50184	50	JW-SL71212	50
JW-R1216CT	33	JW-SK280F	37	JW-SL50211	50	JW-SL71213	50
JW-R1216P	33	JW-SK280LC	37	JW-SL50212	50	JW-SL71214	50
JW-R1400CT	33	JW-SK280LD	37	JW-SL50213	50	JW-SL71251	50
JW-R1400P	33	JW-SK280LF	37	JW-SL50214	50	JW-SL71252	50
JW-R1418CT	33	JW-SK280LM	37	JW-SL50251	50	JW-SL71253	50
JW-R1418P	33	JW-SK280LN	37	JW-SL50252	50	JW-SL71254	50
JW-R1520CT	33	JW-SK280LP	37	JW-SL50253	50	JW-SLI	86
JW-R1520P	33	JW-SK280M	37	JW-SL50254	50	JW-SP19	23
JW-R1600CT	33	JW-SK280N	37	JW-SL53141	50	JW-SP9.5	23
JW-R1600P	33	JW-SK280P	37	JW-SL53142	50	JW-SSB100	39
JW-R1622CT	33	JW-SL36141	50	JW-SL53143	50	JW-SSB115	39
JW-R1622P	33	JW-SL36142	50	JW-SL53144	50	JW-SSB60	39
JW-R1800CT	33	JW-SL36143	50	JW-SL53181	50	JW-SSB80	39
JW-R1826CT	33	JW-SL36144	50	JW-SL53182	50	JW-SSD1826	21
JW-R2500CT	33	JW-SL36181	50	JW-SL53183	50	JW-ST	8
JW-R2700CT	33	JW-SL36182	50	JW-SL53184	50	JW-TC30	94
JW-R2900CT	33	JW-SL36183	50	JW-SL53211	50	JW-TC46	42
JW-R3020CT	33	JW-SL36184	50	JW-SL53212	50	JW-TRT	93
JW-R3100CT	33	JW-SL36211	50	JW-SL53213	50	JW-VB76D	106
JW-RB150	95	JW-SL36212	50	JW-SL53214	50	JW-VC40	88
JW-RB261B	92	JW-SL36213	50	JW-SL53251	50	JW-VC46	42
JW-RB300	95	JW-SL36214	50	JW-SL53252	50	JW-VC48	88
JW-RIS1	82	JW-SL36251	50	JW-SL53253	50	JW-VC80	88
JW-RIS2	82	JW-SL36252	50	JW-SL53254	50	JW-VC84	88
JW-RT	8	JW-SL36253	50	JW-SL60141	50	JW-VO23	24
JW-S	6	JW-SL36254	50	JW-SL60142	50	JW-VO24	24
JW-S1000C	39	JW-SL43141	50	JW-SL60143	50	JW-VO33	24
JW-S102	20	JW-SL43142	50	JW-SL60144	50	JW-VO34	24
JW-S120	20	JW-SL43143	50	JW-SL60181	50	JW-VOB	24
JW-S1200C	39	JW-SL43144	50	JW-SL60182	50	JW-W1000A	38
JW-S1500C	39	JW-SL43181	50	JW-SL60183	50	JW-W1000C	38
JW-S1800C	39	JW-SL43182	50	JW-SL60184	50	JW-W1290C	38
JW-S20	20	JW-SL43183	50	JW-SL60211	50	JW-W1511C	38
JW-S40	20	JW-SL43184	50	JW-SL60212	50	JW-W500A	38
JW-S8	20	JW-SL43211	50	JW-SL60213	50	JW-W500C	38
JW-S81	20	JW-SL43212	50	JW-SL60214	85	JW-W600A	38
JW-SB30	106	JW-SL43213	50	JW-SL60251	37	JW-W600C	38



# Product Index

Art.No	Page	Art.No	Page	Art.No	Page	Art.No	Page
JW-W700A	38	P-038	41	P-084P	18	PSH7218	57
JW-W700C	38	P-039	41	P-085	19	PSH7221	57
JW-W800A	38	P-040	41	P-086	19	PSH7224	57
JW-W800C	38	P-041	34	P-090C	15	PSS361864	60
JW-W900A	38	P-042	34	P-090P	16	PSS361872	60
JW-W900C	38	P-042A	34	P-091C	15	PSS362164	60
JW-WGS	112	P-043	34	P-091P	16	PSS362172	60
JW-WM12	91	P-043A	34	P-092C	15	PSS362172M	64
JW-WM18	91	P-046	22	P-092P	16	PSS362464	60
JW-WM21	91	P-050	36	P-093C	15	PSS362472	60
JW-WM6	91	P-060C	14	P-093P	16	PSS362472M	64
JW-WM9	91	P-060P	14	P-100C	15	PSS421864	60
JW-WSC3614	68	P-061C	14	P-100P	16	PSS421872	60
JW-WSC4814	68	P-061P	14	P-101C	15	PSS422164	60
JW-WSS3614	68	P-062C	14	P-101P	16	PSS422172	60
JW-WSS4814	68	P-062P	14	P-102P	16	PSS422172M	64
JW-WV3952	79	P-063C	14	P-103C	15	PSS422464	60
JW-WV3952-01	79	P-063P	14	P-103P	16	PSS422472	60
JW-X3001	45	P-064C	14	P-104C	15	PSS422472M	64
JW-X4501	45	P-064P	14	P-104P	16	PSS481864	60
JW-X6001	45	P-065C	14	P-105C	15	PSS481872	60
JW-X8001	45	P-065P	14	P-105P	16	PSS482164	60
JW-X9001	45	P-066C	14	P-106C	15	PSS482172	60
JW-XC150	95	P-066P	14	P-106P	16	PSS482172M	64
JW-XC300	95	P-067C	17	P-107C	15	PSS482464	60
JW-XC300M	95	P-067P	18	P-107P	16	PSS482472	60
P-001	34	P-068C	17	P-035	41	PSS482472M	64
P-002	34	P-068P	18	P-036	41	PSS541864	60
P-003	35	P-069C	17	P-037	41	PSS541872	60
P-004	35	P-069P	18	PSH3614	57	PSS542164	60
P-005	35	P06DS	17	PSH3618	57	PSS542172	60
P-006	36	P06DSP	18	PSH3621	57	PSS542172M	64
P-007	36	P-070C	17	PSH3624	57	PSS542464	60
P-008	36	P-070P	18	PSH4214	57	PSS542472	60
P-009	36	P-071C	17	PSH4218	57	PSS542472M	64
P-010	36	P-071P	18	PSH4221	57	PSS601864	60
P-011	36	P-072C	17	PSH4224	57	PSS601872	60
P-012	35	P-072P	18	PSH4814	57	PSS602164	60
P-012C	15	P-073C	17	PSH4818	57	PSS602172	60
P-013	35	P-073P	18	PSH4821	57	PSS602172M	64
P-014	35	P-074C	17	PSH4824	57	PSS602464	60
P-015	35	P-074P	18	PSH5414	57	PSS602472	60
P-016	35	P07DS	17	PSH5418	57	PSS602472M	64
P-017	35	P07DSP	18	PSH5421	57	PSS721864	60
P-018	35	P-080	14	PSH5424	57	PSS721872	60
P-030	41	P-081	14	PSH6014	57	PSS722164	60
P-031	41	P-082	14	PSH6018	57	PSS722172	60
P-032	41	P-083C	17	PSH6021	57	PSS722172M	64
P-033	41	P-083P	18	PSH6024	57	PSS722464	60
P-034	41	P-084C	17	PSH7214	57	PSS722472	60

# Product Index

Art.No	Page	Art.No	Page	Art.No	Page	Art.No	Page
PSS722472M	64	PSU542172	58	SN362171	67		
PSU361464	58	PSU542172M	64	SN362463	67		
PSU361472	58	PSU542180	58	SN362471	67		
PSU361480	58	PSU542464	58	SN421863	67		
PSU361864	58	PSU542472	58	SN421871	67		
PSU361872	58	PSU542472M	64	SN422163	67		
PSU361880	58	PSU542480	58	SN422171	67		
PSU362164	58	PSU601464	58	SN422463	67		
PSU362172	58	PSU601472	58	SN422471	67		
PSU362172M	64	PSU601480	58	SN481863	67		
PSU362180	58	PSU601864	58	SN481871	67		
PSU362464	58	PSU601872	58	SN482163	67		
PSU362472	58	PSU601880	58	SN482171	67		
PSU362472M	64	PSU602164	58	SN482463	67		
PSU362480	58	PSU602172	58	SN482471	67		
PSU421464	58	PSU602172M	64	SN541863	67		
PSU421472	58	PSU602180	58	SN541871	67		
PSU421480	58	PSU602464	58	SN542163	67		
PSU421864	58	PSU602472	58	SN542171	67		
PSU421872	58	PSU602472M	64	SN542463	67		
PSU421880	58	PSU602480	58	SN542471	67		
PSU422164	58	PSU721464	58	SN601863	67		
PSU422172	58	PSU721472	58	SN601871	67		
PSU422172M	64	PSU721480	58	SN602163	67		
PSU422180	58	PSU721864	58	SN602171	67		
PSU422464	58	PSU721872	58	SN602463	67		
PSU422472	58	PSU721880	58	SN602471	67		
PSU422472M	64	PSU722164	58	SN721863	67		
PSU422480	58	PSU722172	58	SN721871	67		
PSU481464	58	PSU722172M	64	SN722163	67		
PSU481472	58	PSU722180	58	SN722171	67		
PSU481480	58	PSU722464	58	SN722463	67		
PSU481864	58	PSU722472	58	SN722471	67		
PSU481872	58	PSU722472M	64				
PSU481880	58	PSU722480	58				
PSU482164	58	SN241863	67				
PSU482172	58	SN241871	67				
PSU482172M	64	SN242163	67				
PSU482180	58	SN242171	67				
PSU482464	58	SN242463	67				
PSU482472	58	SN242471	67				
PSU482472M	64	SN301863	67				
PSU482480	58	SN301871	67				
PSU541464	58	SN302163	67				
PSU541472	58	SN302171	67				
PSU541480	58	SN302463	67				
PSU541864	58	SN302471	67				
PSU541872	58	SN361863	67				
PSU541880	58	SN361871	67				
PSU542164	58	SN362163	67				